

LA--1579

Copy 18 of 68

Series A

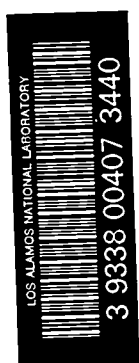

SECRET

UNCLASSIFIED

LOS ALAMOS SCIENTIFIC LABORATORY
of the
UNIVERSITY OF CALIFORNIA

Report written:
June 1953

PUBLICLY RELEASABLE

Per M. Jaim, FSS-16 Date: 10-17-95

By Maclean Lujan, CIC-14 Date: 11-14-95

LA-1579

This document consists of 34 pages

[REDACTED]

f 68 copies, Series A

Classification changed to UNCLASSIFIED
by authority of the U. S. Atomic Energy Commission
Just #10 5-10-57

Per Jack H. Kahn
J. Martinez
5-27-57

TOPSY By REPORT LIBRARY

A REMOTELY CONTROLLED MACHINE
FOR THE STUDY OF CRITICAL ASSEMBLIES

[REDACTED]
contains restricted data as defined
in the [REDACTED] manual
of [REDACTED]
an authorized person

Work done by:

Members of Group W-2

Report written by:

R. H. White

LOS ALAMOS NATL. LAB LIBS.
3 9338 00407 3440

CRITICALITY HAZARDS

[REDACTED]

UNCLASSIFIED



 01110

UNCLASSIFIED

CRITICALITY HAZARDS

Distributed: OCT 6 1953

LA-1579

Los Alamos Report Library	1 - 20
Argonne National Laboratory	21 - 22
Armed Forces Special Weapons Project (Sandia)	23
Atomic Energy Commission, Washington	24 - 26
Brookhaven National Laboratory	27
California Research and Development Company	28 - 29
Carbide and Carbon Chemicals Company (K-25 Plant)	30 - 31
Carbide and Carbon Chemicals Company (ORNL)	32 - 34
Carbide and Carbon Chemicals Company (Y-12 Plant)	35 - 36
Dow Chemical Company (Rocky Flats)	37
duPont Company, Augusta	38 - 39
duPont Company, Wilmington	40
General Electric Company, Richland	41 - 42
Hanford Operations Office	43
Idaho Operations Office	44
Knolls Atomic Power Laboratory	45 - 46
National Advisory Committee for Aeronautics, Cleveland	47
Patent Branch, Washington	48
Savannah River Operations Office, Augusta	49
University of California Radiation Laboratory, Berkeley	50 - 51
University of California Radiation Laboratory, Livermore	52 - 53
Technical Information Service, Oak Ridge	54 - 68



 01110

UNCLASSIFIED

~~SECRET~~
SECRET

UNCLASSIFIED

ABSTRACT

This report describes the construction, operation, and typical uses of Topsy, the versatile, remotely controlled, critical assembly machine at Pajarito.

Section 1 covers the mechanical design of the machine, and the hydraulic and electrical operation of the various components.

Section 2 describes how Topsy is used for investigating reacting metal assemblies. Procedures for establishing a delayed critical configuration and operation at delayed critical are illustrated for the oralloy-tuballoy system. Also included are brief descriptions of oralloy-nickel, plutonium-tuballoy, and low density and concentration assemblies that have been made on the machine.

SECRET

UNCLASSIFIED



REF ID: A66000

UNCLASSIFIED

CONTENTS

	<u>Page</u>
Abstract	3
1. Mechanical Design and Operation	5
2. Assemblies Operating at Delayed Critical	25
3. References	34

REF ID: A66000

UNCLASSIFIED



REF ID: A66000

•• •• : •• :•• :••

1. Mechanical Design and Operation

The original design specifications for Topsy were set during the early stages of development of the remotely controlled facilities at Pajarito. A machine was needed which would assemble known amounts of potentially dangerous fissile material by remote control, and would permit the safe investigation of reacting assemblies.

The design of Topsy was governed by two basic requirements: (1) The protection of personnel and equipment requires that after the machine is "loaded" by hand, the remote assembly operation must proceed safely under controlled conditions; (2) Sufficient precision must be built into the machine to insure:

- (a) The proper alignment and positioning of mating active material pieces,
- (b) Accurate position indication of moving parts,
- (c) Reproducibility of position of moving parts.

In the designing of Topsy, flexibility of operation was constantly kept in mind. The term "universal" is frequently applied in the sense that the machine is not restricted to one particular setup, but can be adapted to nuclear components of various sizes and geometries.

Figure 1 shows the final design and complete assembly

0315

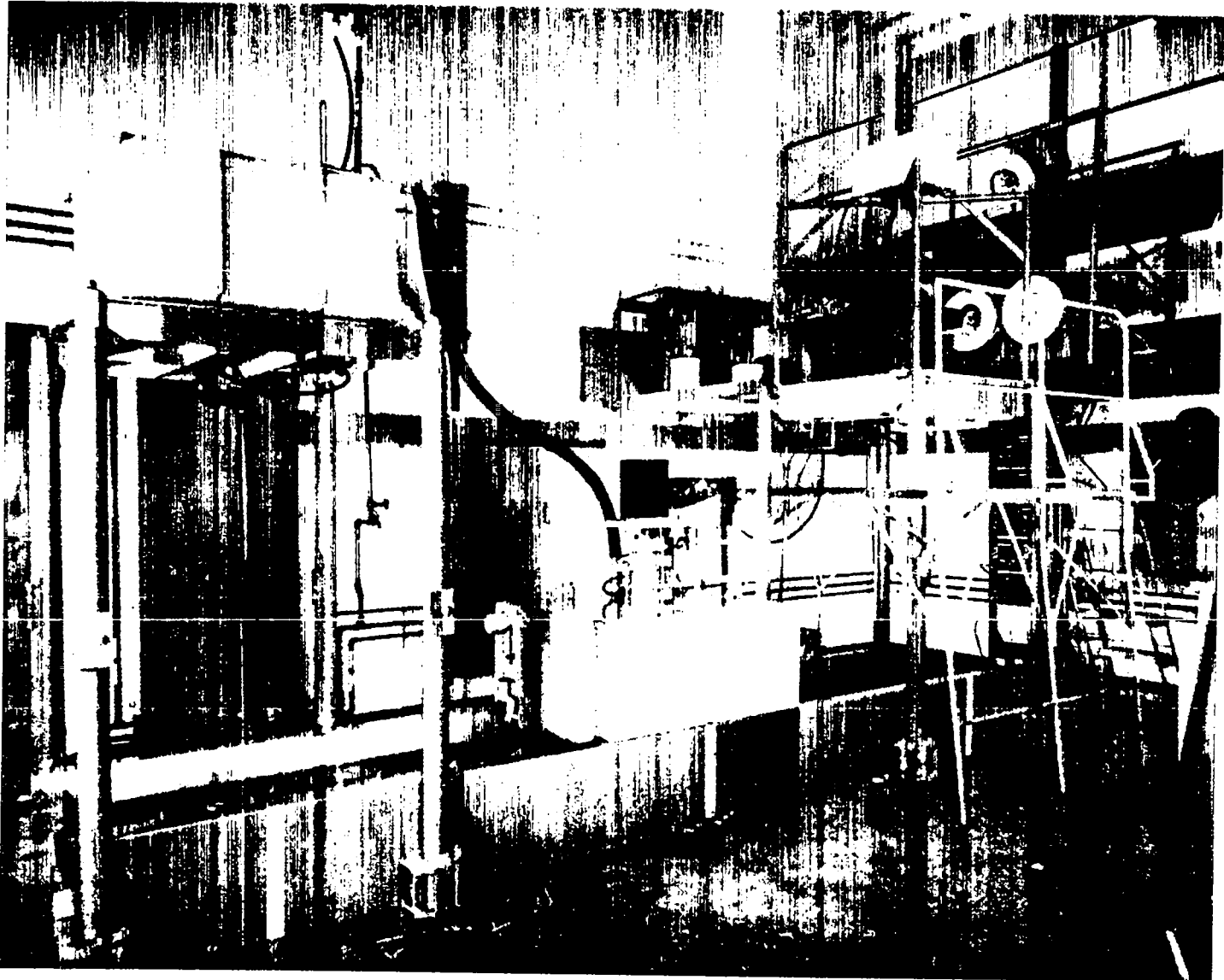

Fig. 1. Topsy, complete assembly, showing the carriage centered between the safety test section on the left and the critical assembly section on the right.

of the machine. There are five main subassemblies consisting of: (1) the track section; (2) the carriage (cart); (3) the safety test section; (4) the critical assembly section; and (5) the hydraulic and electrical systems.

1.1 The Track Section. The track section (Fig. 2) is of welded construction, built in four matching sections which were doweled and bolted together before the running surfaces and mounting pads were machined. Triangular-type rails insure the accurate location of the carriage in operating positions, while dowel pin bushings in the track-end sections maintain the position of the carriage with respect to the platform structures. To help maintain the accuracy built into the machine, the track assembly is bolted to a concrete floor and carefully leveled.

1.2 The Carriage. The carriage subassembly consists of the hydraulic lift cylinder (Fig. 3), the locating dowel pin, the horizontal carriage drive mechanism, and the hydraulic power system. The chief purpose of the carriage is to carry and raise into position all or part of the active material core unit. The double-acting hydraulic lift cylinder is specially designed for smooth operation and maximum rigidity in its extended position. When the lift is in the up, or assembled, position, constant pressure is maintained on the cylinder to keep the platen seated against carefully set

8

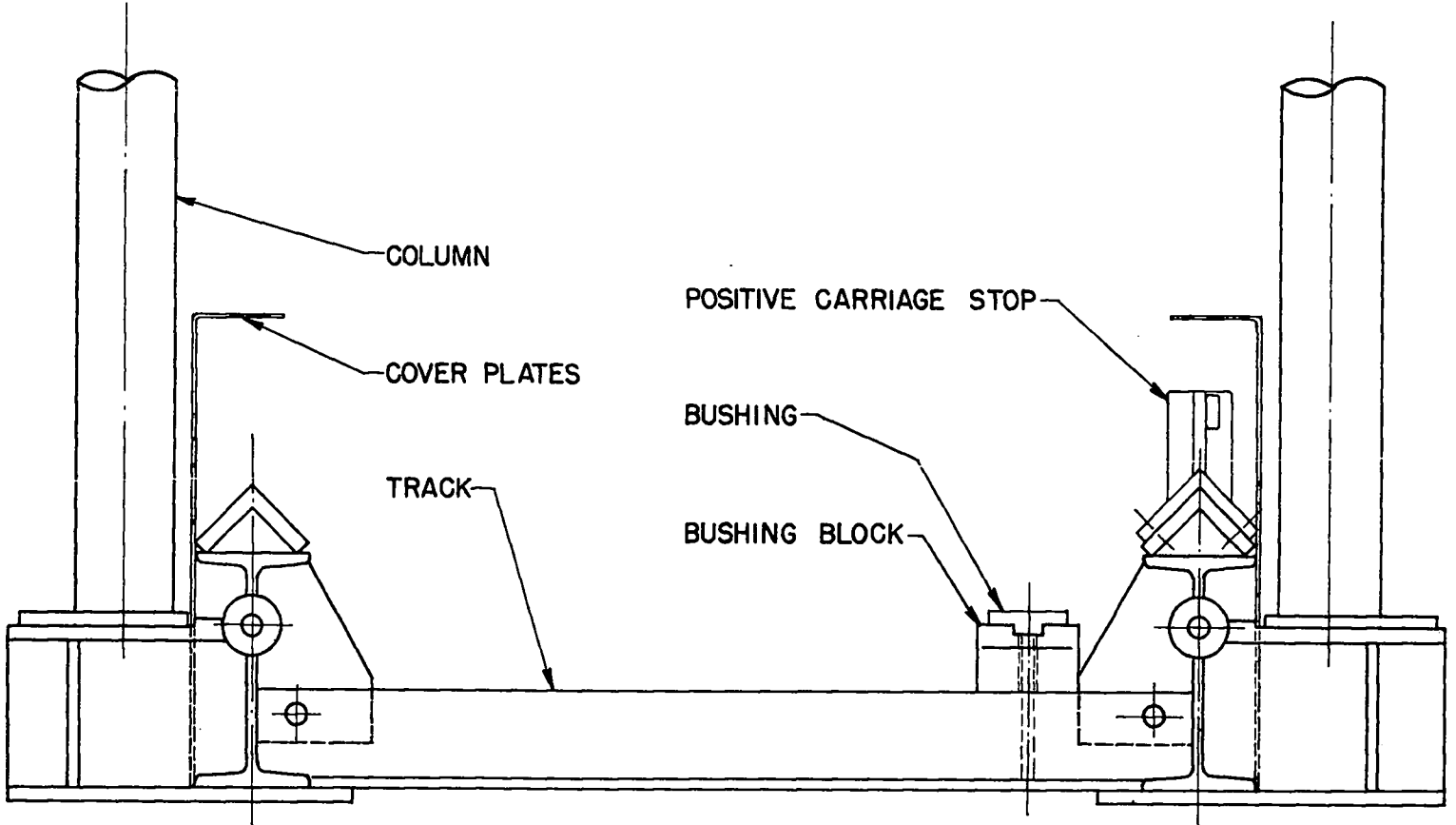

Fig. 2. Sectional view of the track weldment.

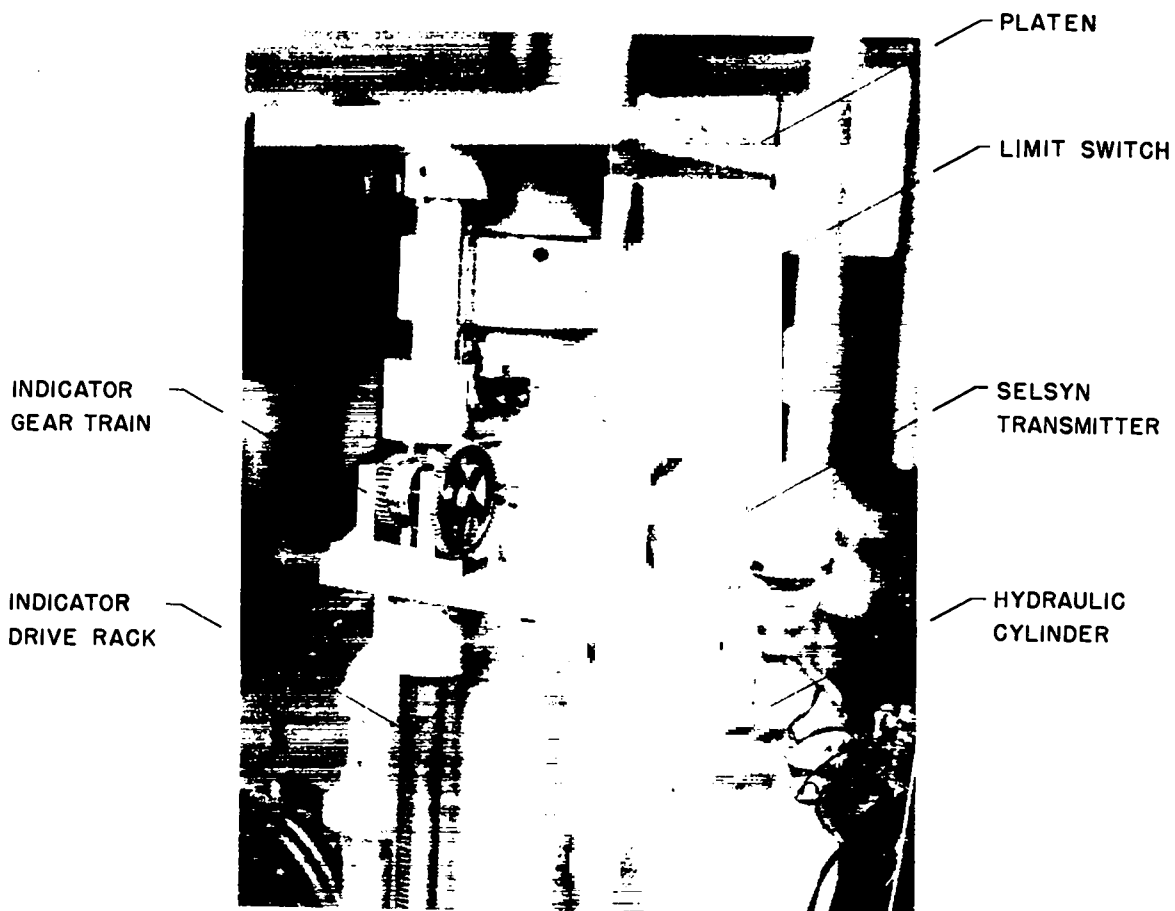

Fig. 3. Lift cylinder and vertical position indicator.

positive stops.

The locating dowel pin is hydraulically operated, and is lowered into the track bushing only when the carriage is in position under one of the platform sections. Horizontal motion of the carriage is obtained with a hydraulic motor which drives one of the axles through a gear train. The speed of the motor can be varied by changing the delivery rate of the pump.

1.3 The Safety Test Section. During initial critical mass determinations it is frequently desirable to establish, by remote control, the safe mass limit for hand-stacking the active material core unit carried on the lift. The safety test section (Fig. 4) is designed to simulate the tamping that would be provided by three or four people closely surrounding the active material unit. Eighty gallons of water are contained in a doughnut-shaped tank with a square cross section, the water level at all times being indicated by a float-operated selsyn. A large drain line permits rapid "dumping" of the water in case of a scram.

1.4 The Critical Assembly Section. The critical assembly section (Fig. 5) provides the means for obtaining critical mass measurements, and for conducting studies under delayed critical conditions. Its principal components are the safety block assembly, the control rod drive unit, the source

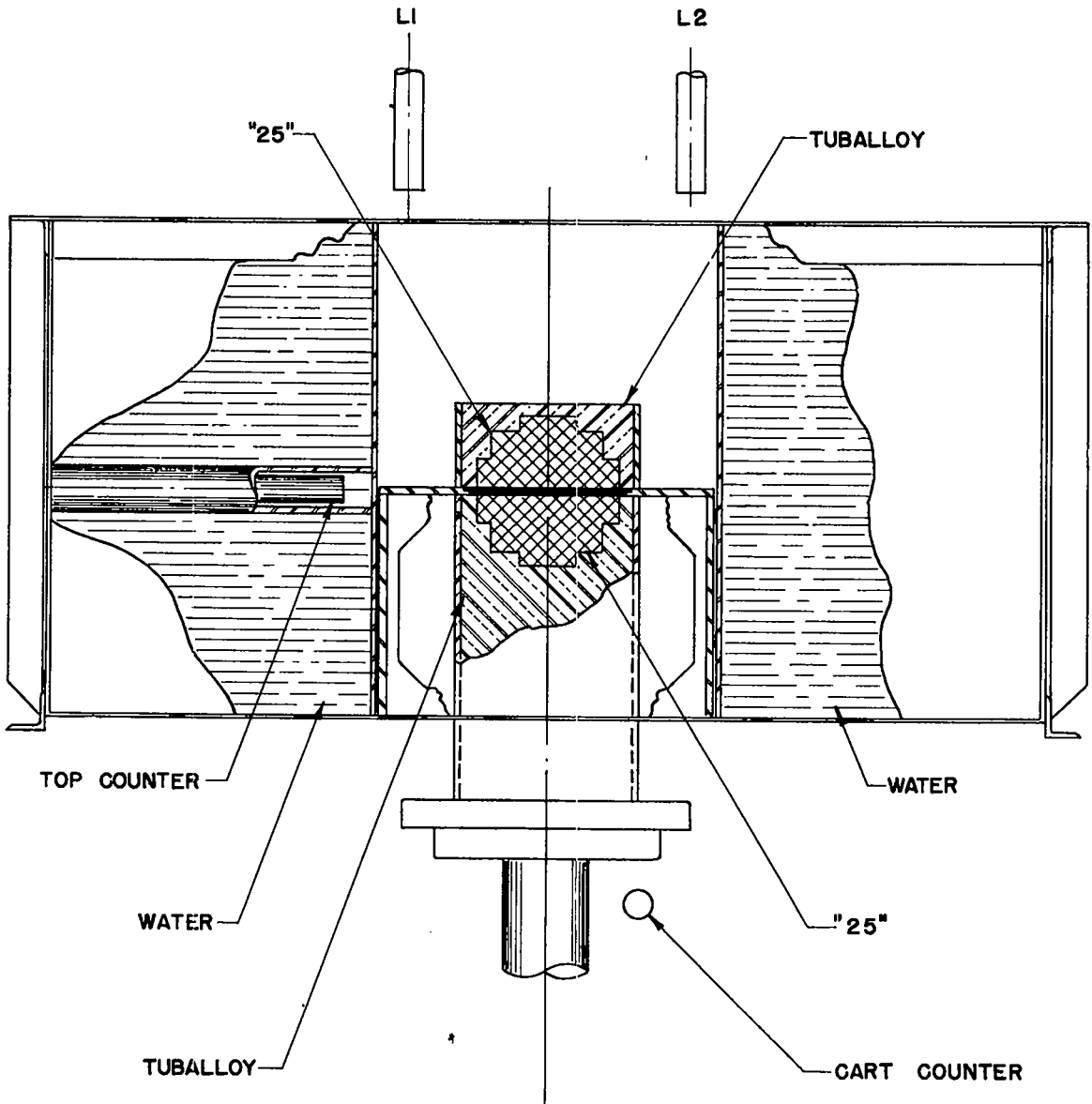

Fig. 4. Sectional view of an oralloy ("25") core assembled in the water tank of the safety test section.

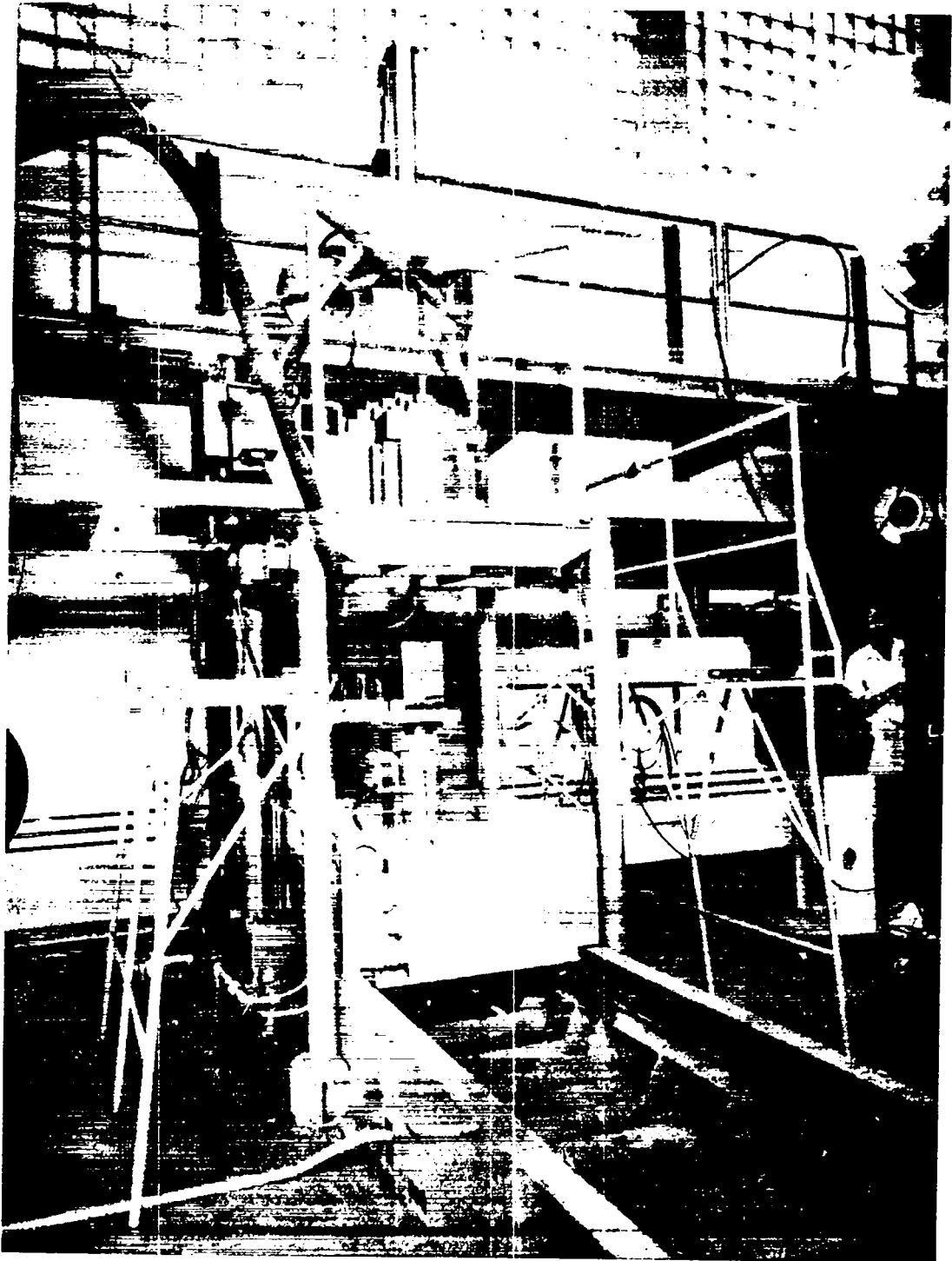

Fig. 5. Critical assembly section, showing the carriage in position under the main tamper.

rod assembly, and the main tamper.

A separate hydraulic system is used to move the heavy safety block into position and simultaneously to compress two large retracting springs. In case of a scram, the hydraulic pressure is released and the safety block is accelerated rapidly outward by the springs until a shock absorber is engaged.

The control rod drive unit (Fig. 6) permits the accurate reproducible positioning of the two control rods by electric motor-driven, lead screws. The rods can be operated independently or together, and their position at all times is indicated by selsyn transmitters to within 0.001 inch throughout the 10 inch travel.

The mock fission source used during the approach to delayed critical is removed vertically from the assembly by the source rod drive mechanism (Fig. 7). It may be raised or lowered slowly by a motor-driven rack, or released quickly from the down position by a compressed spring.

1.5 The Hydraulic System. When the heavy components of the nuclear assembly are run into position, smooth positive action and quick reversal of motion are necessary. These requirements are best satisfied by a properly designed oil hydraulic system. In addition to being a very simple means of applying power, hydraulic systems permit safe application

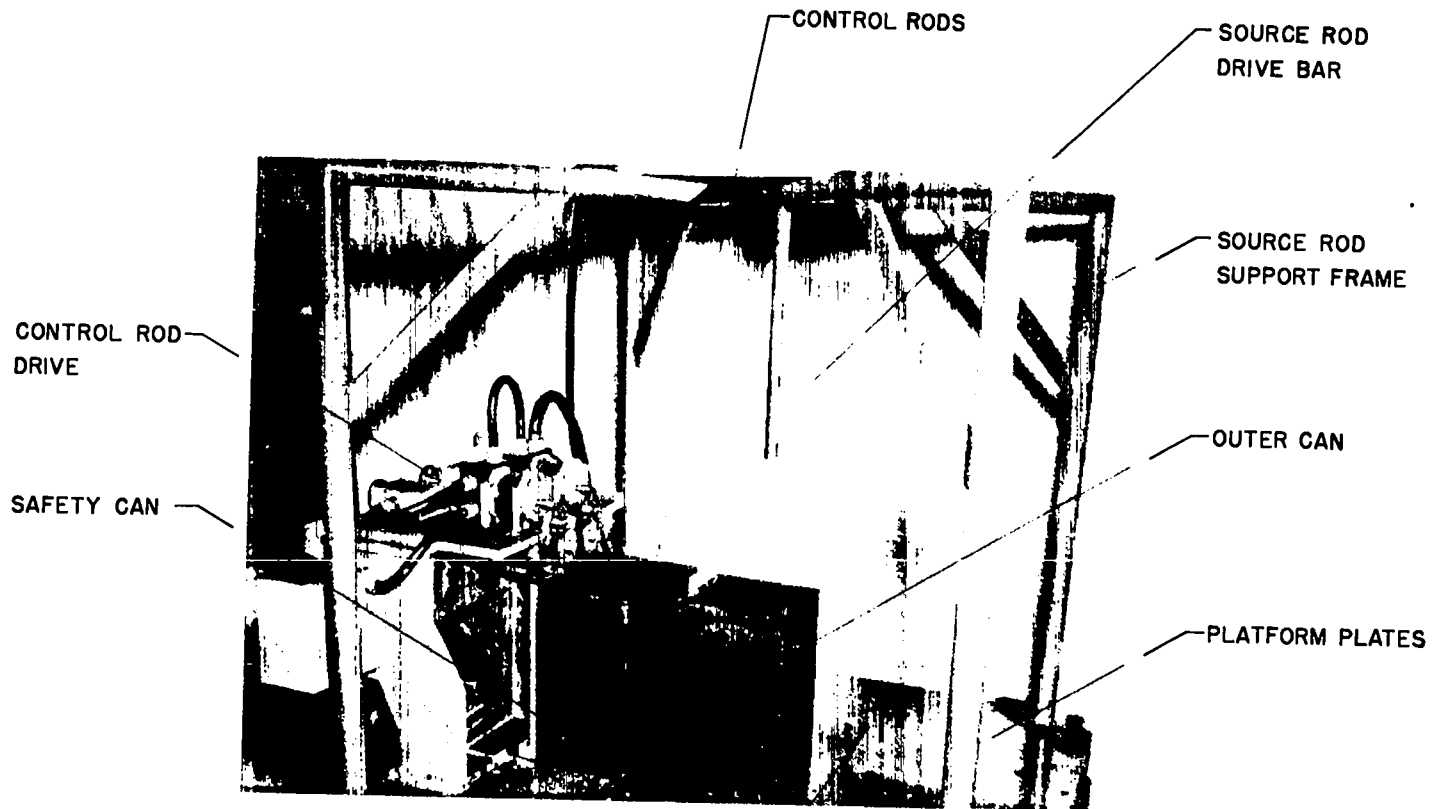

Fig. 6. Control rod drive unit with all tamper blocks removed.

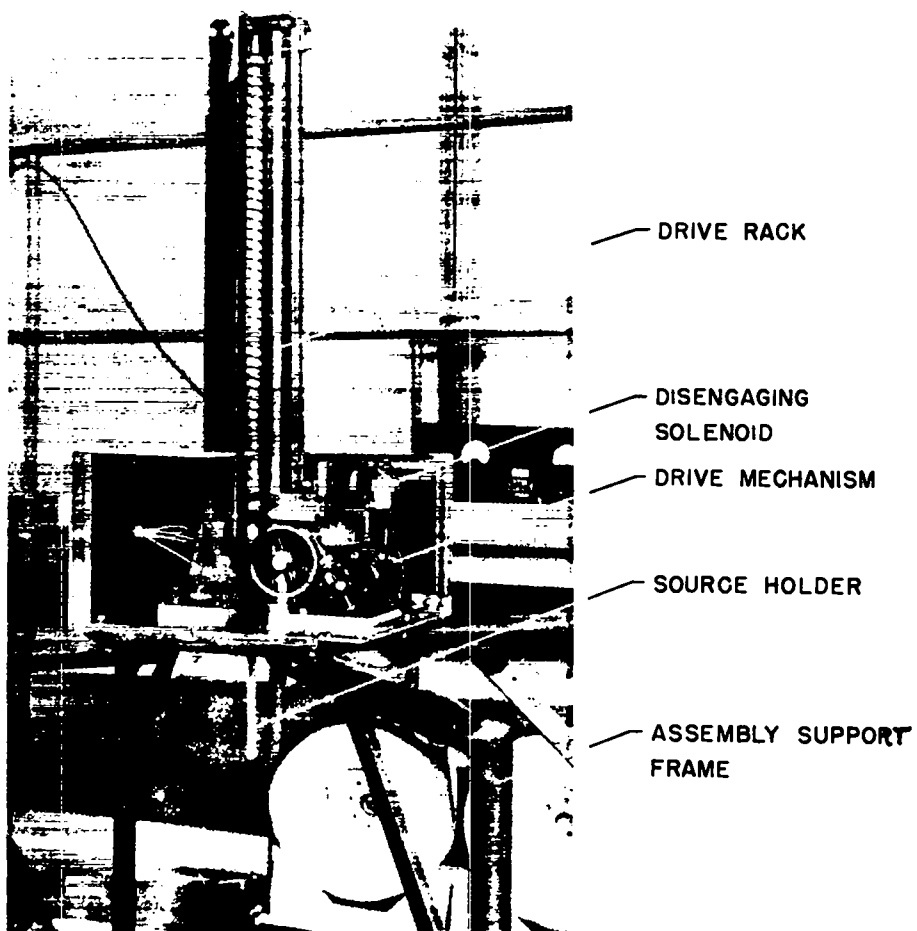
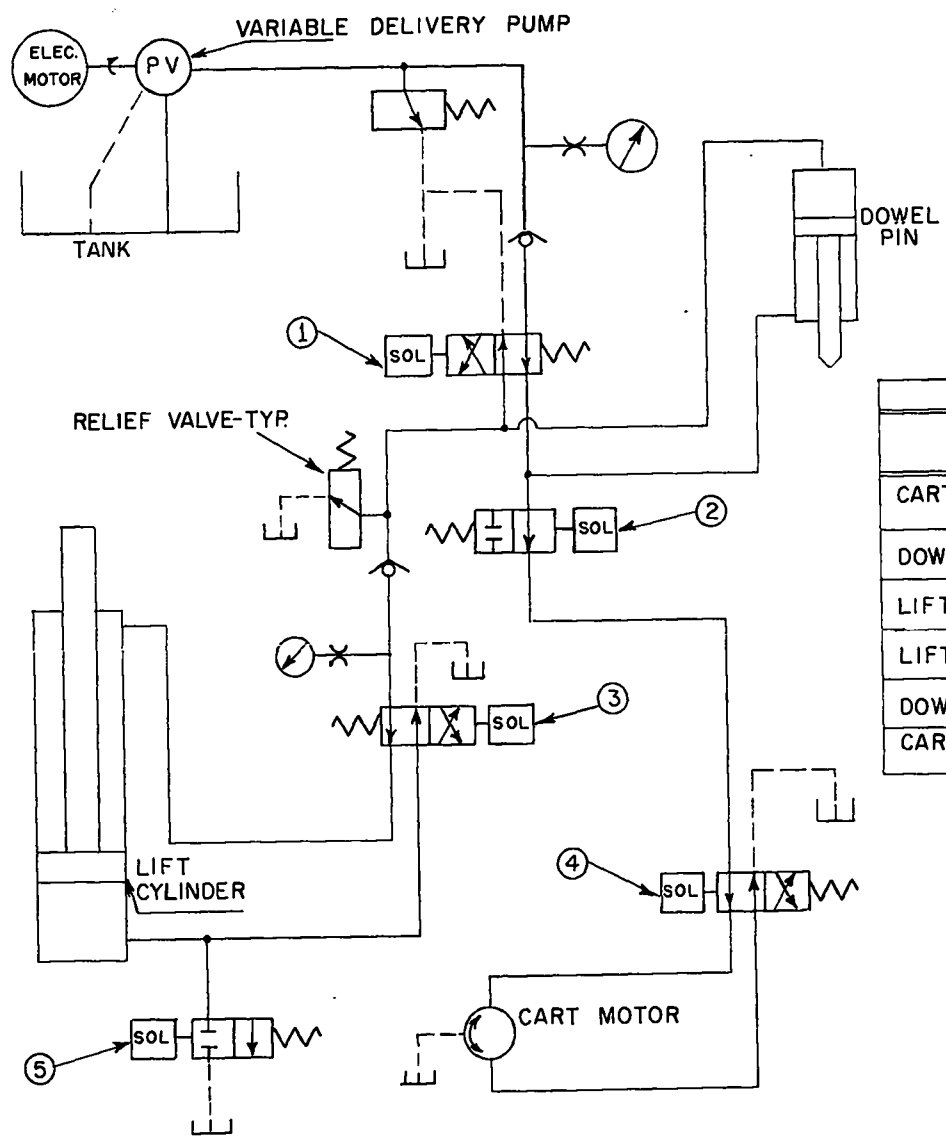

Fig. 7. Source rod drive mechanism.

of power in that the pressure relief valve protects the assembly from excessive stresses which could result in possible damage to expensive nuclear materials.

Two separate hydraulic systems are used in the operation of Topsy. The main system controls the horizontal movement of the carriage, the vertical motion of the lift, and the vertical motion of the locating dowel pin. All the hydraulic equipment for this system, together with the necessary electrical components, is contained on the carriage. Electrical power is supplied to the carriage through a flexible cable from the wall-mounted relay cabinet. The secondary hydraulic system is mounted on the critical assembly platform, and is used to control the horizontal movement of the safety block. The second system receives its pressure from a power unit located on the floor beneath the platform.

Figure 8 is a schematic diagram of the main hydraulic system, and a table is included to indicate the operating sequence of the valves. A variable delivery pump is used to adjust the stroke velocity of the lift and the horizontal speed of the carriage. The two selector valves, (1) and (3), are installed in such a way that if some electrical failure should prevent their operation the lift cannot be raised into operating position. A large normally open valve [(5) in Fig. 8] is used for the scram valve. When it is opened by



OPERATION	VALVE NUMBER									
	1		2		3		4		5	
	E	D	E	D	E	D	E	D	E	D
CART TO ASSEMBLY POSITION		X	X			X	X			X
DOWEL DOWN	X			X	X	X		X	X	
LIFT UP	X			X	X			X	X	
LIFT DOWN	X			X		X		X	X	
DOWEL UP		X		X		X		X	X	
CART TO TRACK CENTER		X	X			X		X	X	

E - ENERGIZE
D - DE-ENERGIZE

Fig. 8. Schematic diagram of the carriage hydraulic system.

the safety circuit, the lift is allowed to drop rapidly by gravity.

1.6 The Electrical Control System. Topsy is operated by remote control from a distance of 1200 feet by an electrical (control) system consisting of three major sections: (1) the control panel, located in the control room; (2) the relay cabinet in the assembly building; and (3) the electrical devices on the machine. Power for all primary control and indicating circuits is supplied by a 120 volt single-phase source at the control room. For all three-phase and other single-phase circuits, power is supplied by a 208/120 volt, three-phase, four-wire source at the assembly building.

Indicating lights on the control panel (Fig. 9) are used to indicate the position limits of movable components, and to show whether certain relays are open or closed. Selsyn receivers that drive mechanical counters accurately indicate the positions of the lift (to within 0.01 inch), the control rods, and the depth of water in the safety test tank (to within 0.10 inch). All circuits are designed for fail-safe operation so that, in case of a power failure or faulty equipment, all devices will remain in, or return to, a safe position. Various electrical interlocks are incorporated into the apparatus to prevent equipment damage and to insure that a nuclear assembly will proceed as safely as possible.

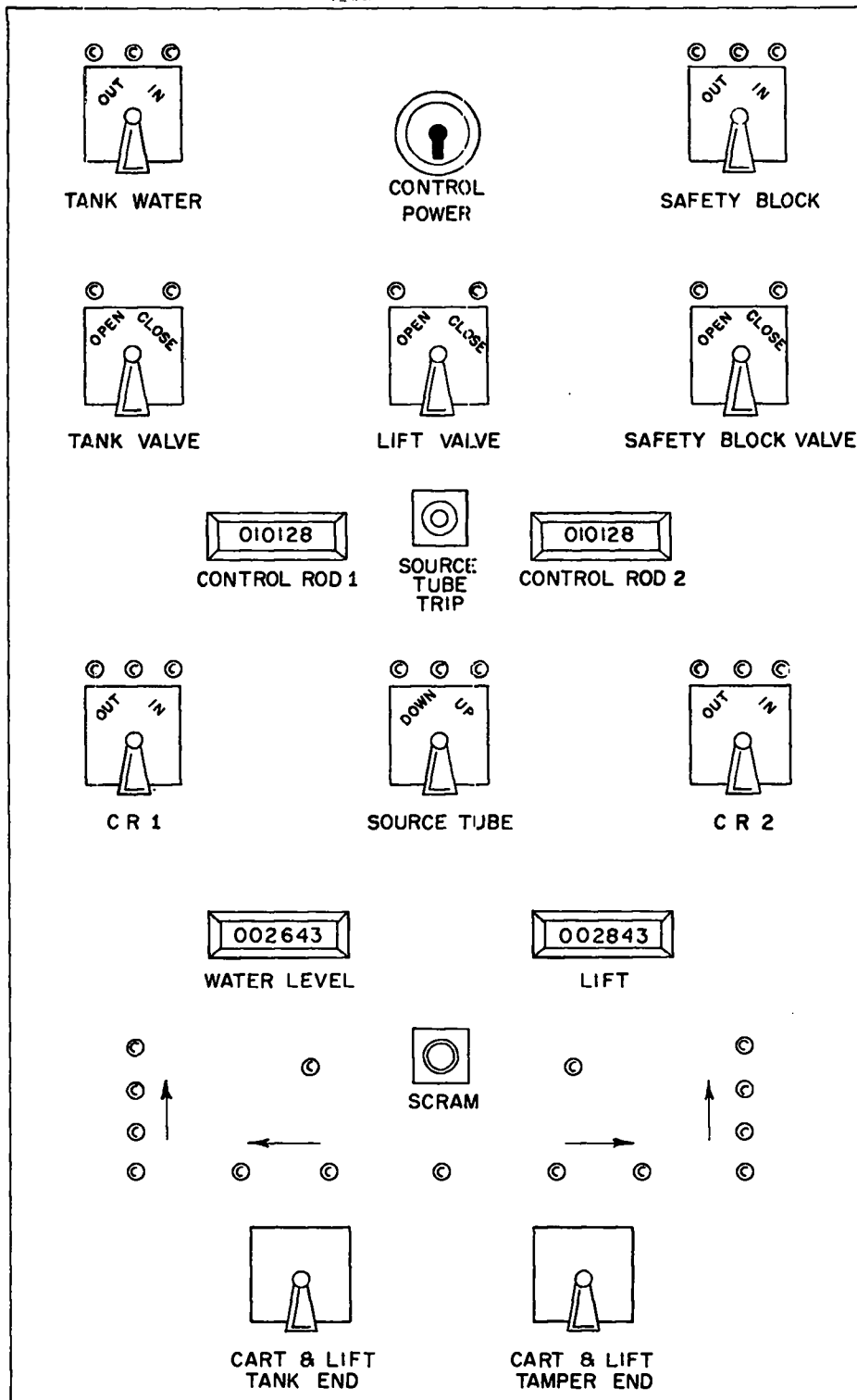

Fig. 9. Arrangement of controls for remote operation of Topsy.

For instance, before the lift can be raised into the critical assembly section, the following interlocks must be engaged: (1) safety circuit closed; (2) dowel pin down; (3) safety block in; (4) mock fission source in; (5) both control rods at outer limits.

The safety (scram) circuit is a protection system which causes rapid disassembly whenever the safety relay is opened by the push-button scram in the control room or by the neutron level monitors in the assembly building. This relay has normally open contacts which are in series with the three scram valves controlling the lift, safety block, and water tank. None of these valves can be closed until the safety relay is reset.

1.7 The Nuclear Assembly. The original program of critical mass studies layed out for Topsy called for a flexible tamper and active core assembly that would provide the versatility needed for many different types of experiments. An assembly built of various sizes of cubes and blocks was adopted because of its flexibility, relative ease of fabrication, and economical use of materials.

A sectional view of a typical critical assembly on Topsy is shown in Fig. 10. The active core is a pseudospherical configuration constructed of small blocks of oralloy (93.5% U-235), and surrounded by a tuballoy (normal uranium) tamper.

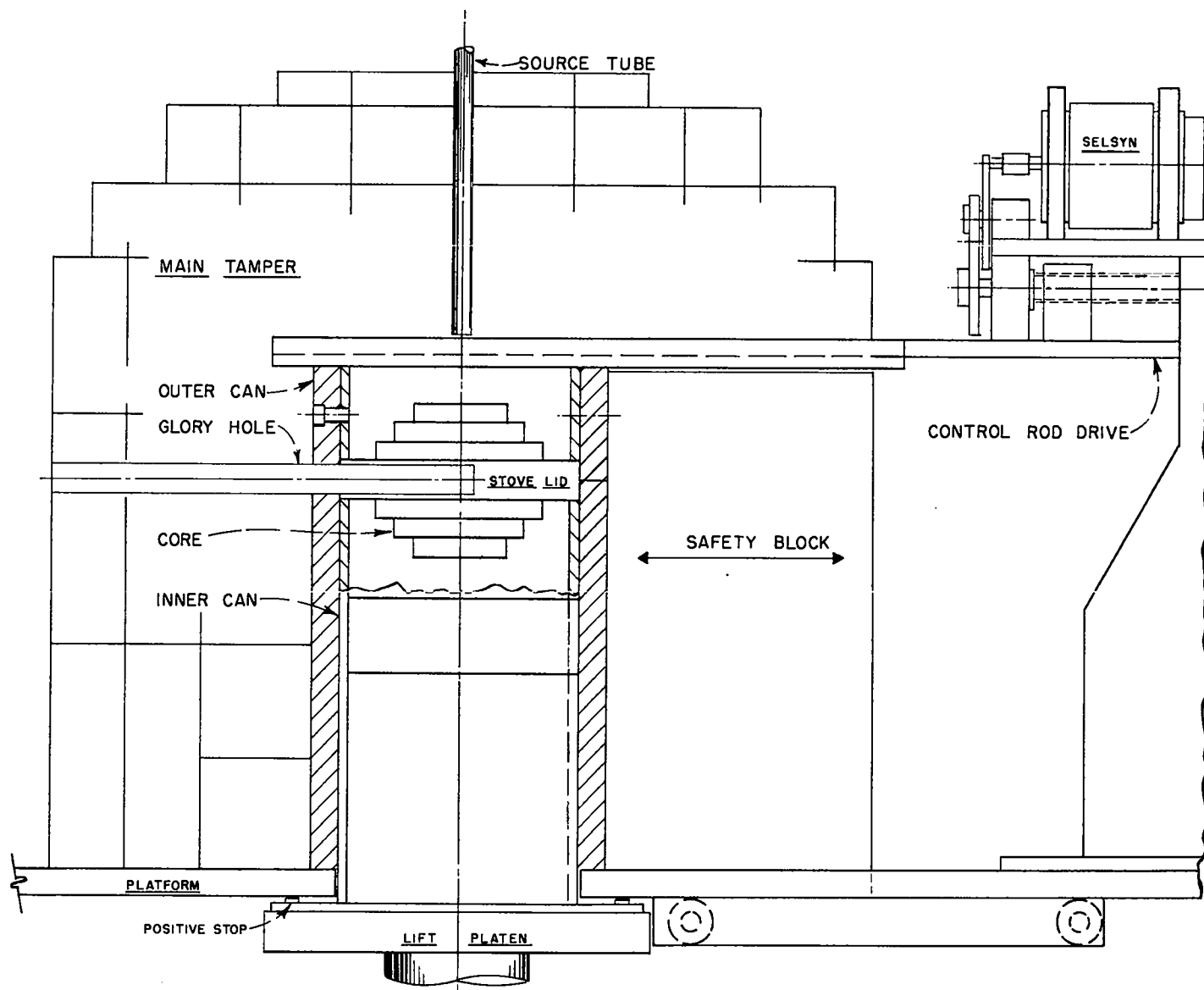

Fig. 10. Sectional view of a typical assembly operating at delayed critical.

In the particular assembly shown, half of the core is supported on the "stove lid" within the main tamper, and half is contained in the tuballoy inner can (Fig. 11) which is secured to the lift platen. This split type of assembly is necessary whenever hand-stacking multiplication⁽¹⁾ limits would be exceeded if the entire core were placed in the inner can. The stove lid arrangement also provides a means for inserting a 7/8 inch diameter access hole into the geometrical center of the complete assembly.

The main tamper is built up with tuballoy blocks to the desired configuration around the stationary outer can and safety block. For ease of handling, the largest size tuballoy block was limited to a 32 pound, 2 x 4 x 6 inch piece. The smallest block used in either tuballoy or oralloy is a 1/2 inch cube.

The mechanical stability of a critical assembly constructed of so many pieces is of considerable importance since reactivity is sensitive to cracks, especially those close to the core. Reactivity changes caused by the development of cracks during operation at delayed critical would result in poor reproducibility of the critical point. It

⁽¹⁾ Multiplication is defined as the ratio of the external neutron flux produced with a mock fission source centered within the active material to the external flux produced with the active material replaced by an identical unit of tuballoy.

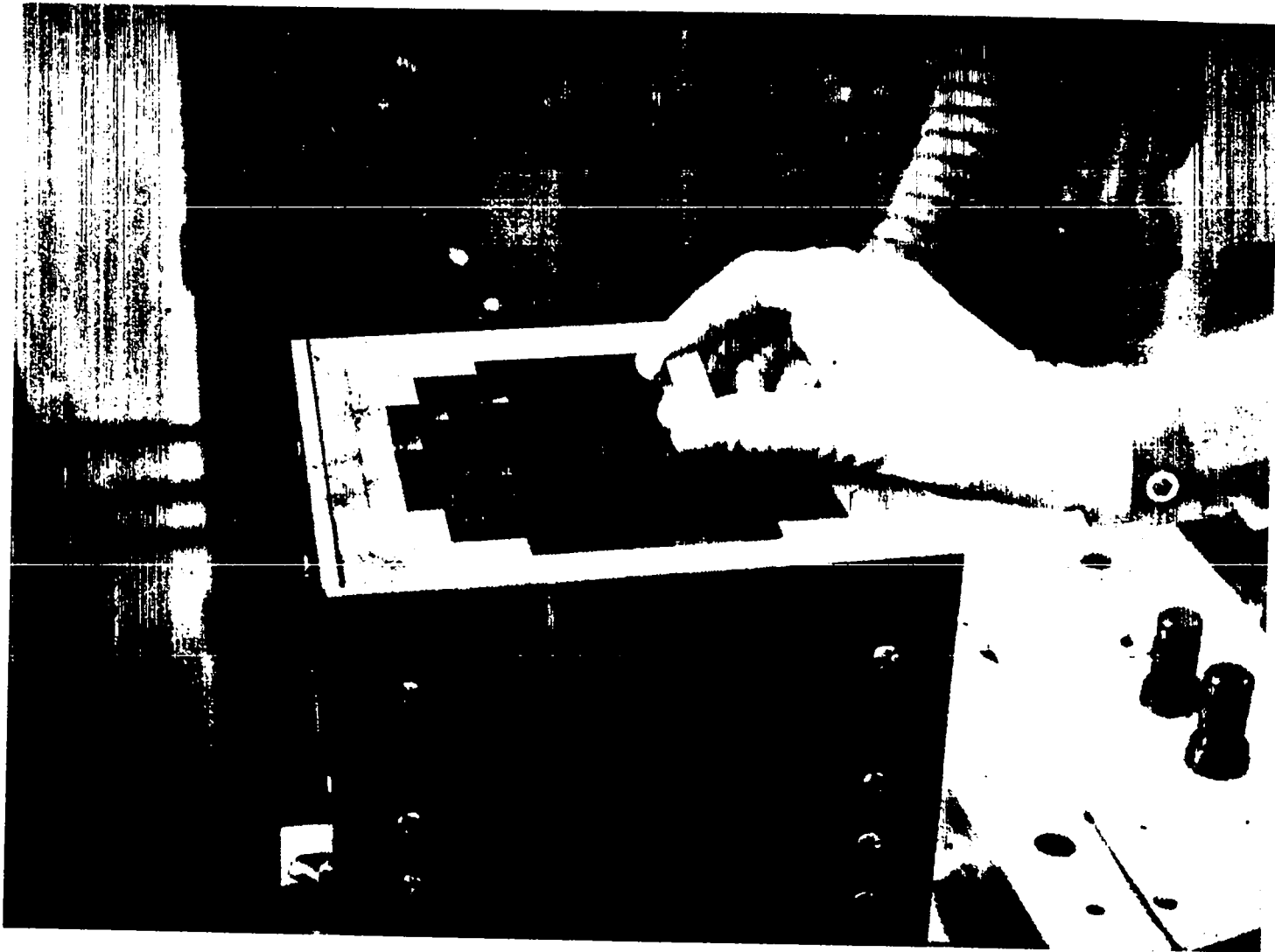

Fig. 11. Lower portion of the active core being constructed in the inner can.

was necessary, therefore, to machine the oralloy and tuballoy pieces to close tolerances (± 0.0005 to 0.005 inch), and to take precautions to prevent warping of the can and control rod plates. Frequent tests during Topsy's history have shown that the tuballoy-orally assembly is capable of reproducing the critical point to within $1/20$ of a cent.⁽¹⁾ This is equivalent to a change in critical mass of approximately 0.2 surface gram.

(1) See Section 2.1, Control Rod Calibration, for definition of cents.

2. Assemblies Operating at Delayed Critical

To determine the critical mass for a given assembly, steps are first taken to insure personnel safety during the hand-stacking of the active core unit. A preliminary series of multiplication measurements is made remotely on successively larger core masses in the water-tamped safety test section (Ref. 1). The complete core may then be stacked in the tuballoy inner can on the lift, or a split assembly, like that shown in Fig. 10, may be made.

The critical mass determination proceeds by remote control in the main tamper section (Fig. 13), and consists of making a series of neutron multiplication measurements as the core mass is gradually increased. By plotting the reciprocal of multiplication, $1/M$, as a function of core mass, the critical mass, M_c , can be determined by drawing a curve through the points and extrapolating to $1/M = 0$ (Fig. 12).

With the establishment of M_c , the active core may be stacked for operation at delayed critical. Should the first of these stackings be slightly subcritical, the mass is increased until it is possible to "catch" delayed critical by running in the control rods. Further mass adjustments may be necessary at this point to utilize the linear reactivity response region of the control rods. To bring the assembly

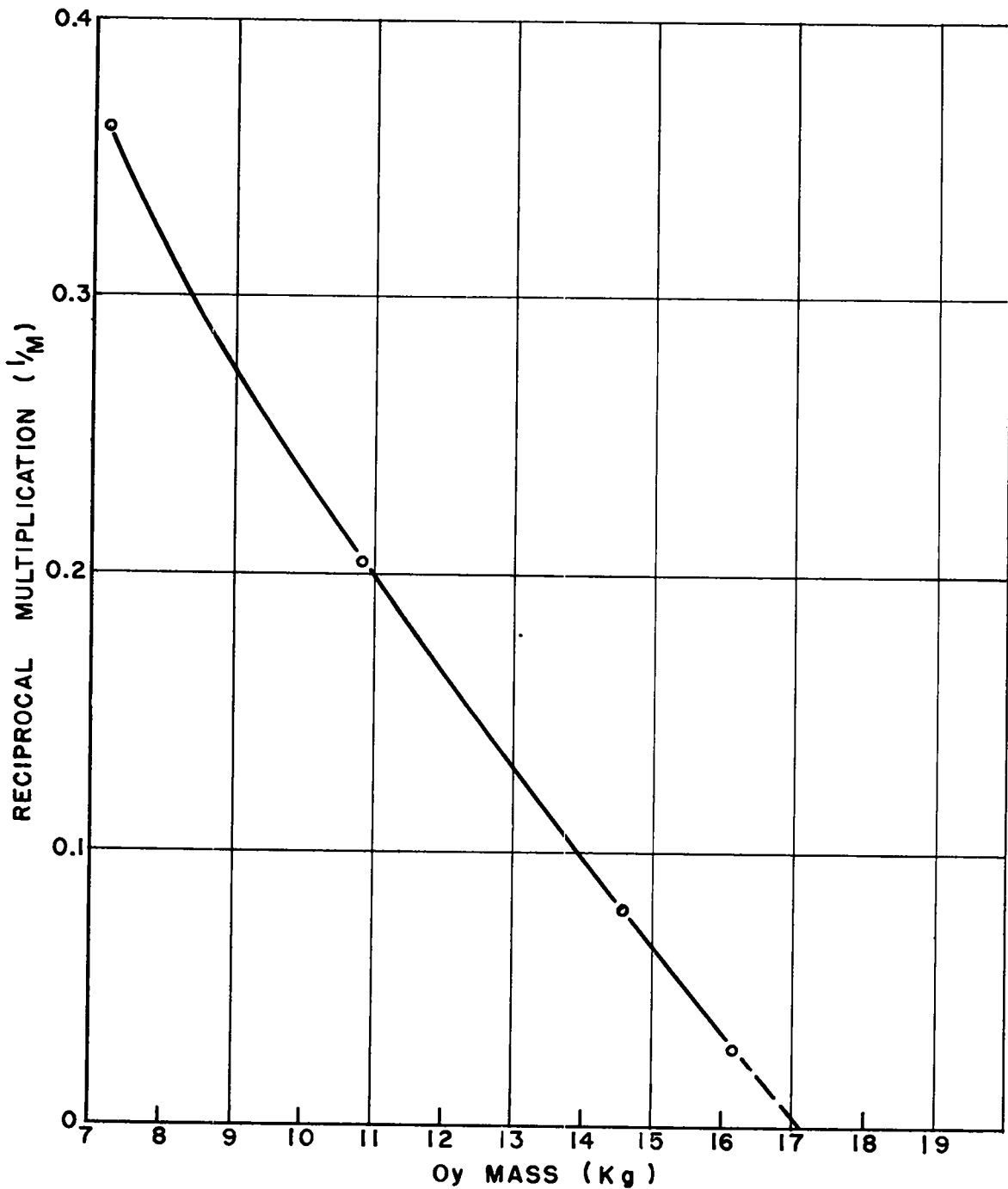

Fig. 12. Typical reciprocal multiplication vs. mass curve, showing the extrapolation to critical (Oy-Tu assembly).

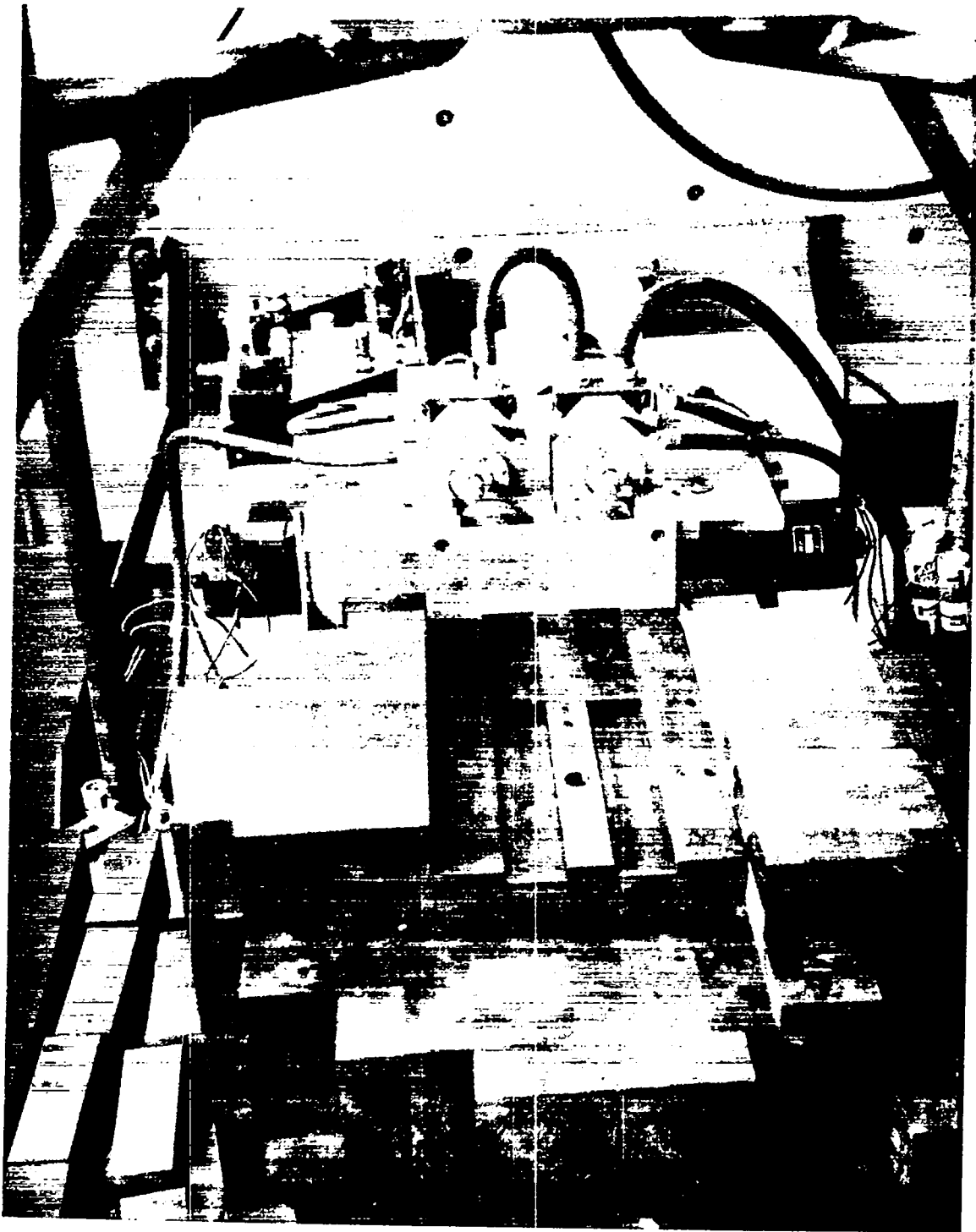

Fig. 13. Main tamper assembly with blocks removed down to the control rod plate.

up to a desired power level (600 watts maximum for 1 hour runs since no forced cooling is provided), the control rods are run in until a slightly supercritical condition is reached. The neutron intensity is allowed to increase slowly to a predetermined value, at which time the excess reactivity is returned to zero by adjusting one or both control rods. The power level is indicated in the control room on recording meters operating from ionization chambers located near the machine.

A basic experimental program for the assembly under delayed critical conditions consists of:

(1) Time behavior (alpha) measurements of prompt neutron chains by the Rossi method (Ref. 2). The alpha value (e-foldings per second) leads to the determination of neutron lifetimes.

(2) Investigation of neutron distributions in the core and tamper by various detection schemes.

(3) Material replacement studies (Ref. 3). Determination of the reactivity effect of foreign materials in the core leads, for example, to information on the absorption and transport cross sections of the materials.

2.1 Control Rod Calibration. The two important functions of the control rods are; (1) to make small changes in reactivity, and (2) to indicate the effect of any assembly



SECRET

changes on reproduction of the delayed critical point. Reliable experimental data depend, therefore, on a control rod calibration that is as complete as possible.

Starting with a delayed critical condition, one control rod is run in to produce a positive period which is measured and plotted against control rod position. After a series of positive period measurements has been made, the period values are converted to units of reactivity in cents by means of calculated curves based on delayed neutron periods. These calculations are made with the Inhour equation which relates the assembly period, T, excess reactivity, and the delayed neutron periods:

$$\text{cents} = 100 \frac{\Delta K}{\gamma f} = 100 \sum_{i=1}^6 \frac{a_i \tau_i}{\tau_i + T}$$

where a_i and τ_i are the abundance and periods, respectively, of the six delayed neutron groups. The resulting calibration curve of reactivity change in cents vs. control rod position is shown in Fig. 14. Specific measurements have shown that there is very little interaction between the two control rods, so the total travel of both rods is then equal to 35 cents.

29 SECRET





SECRET

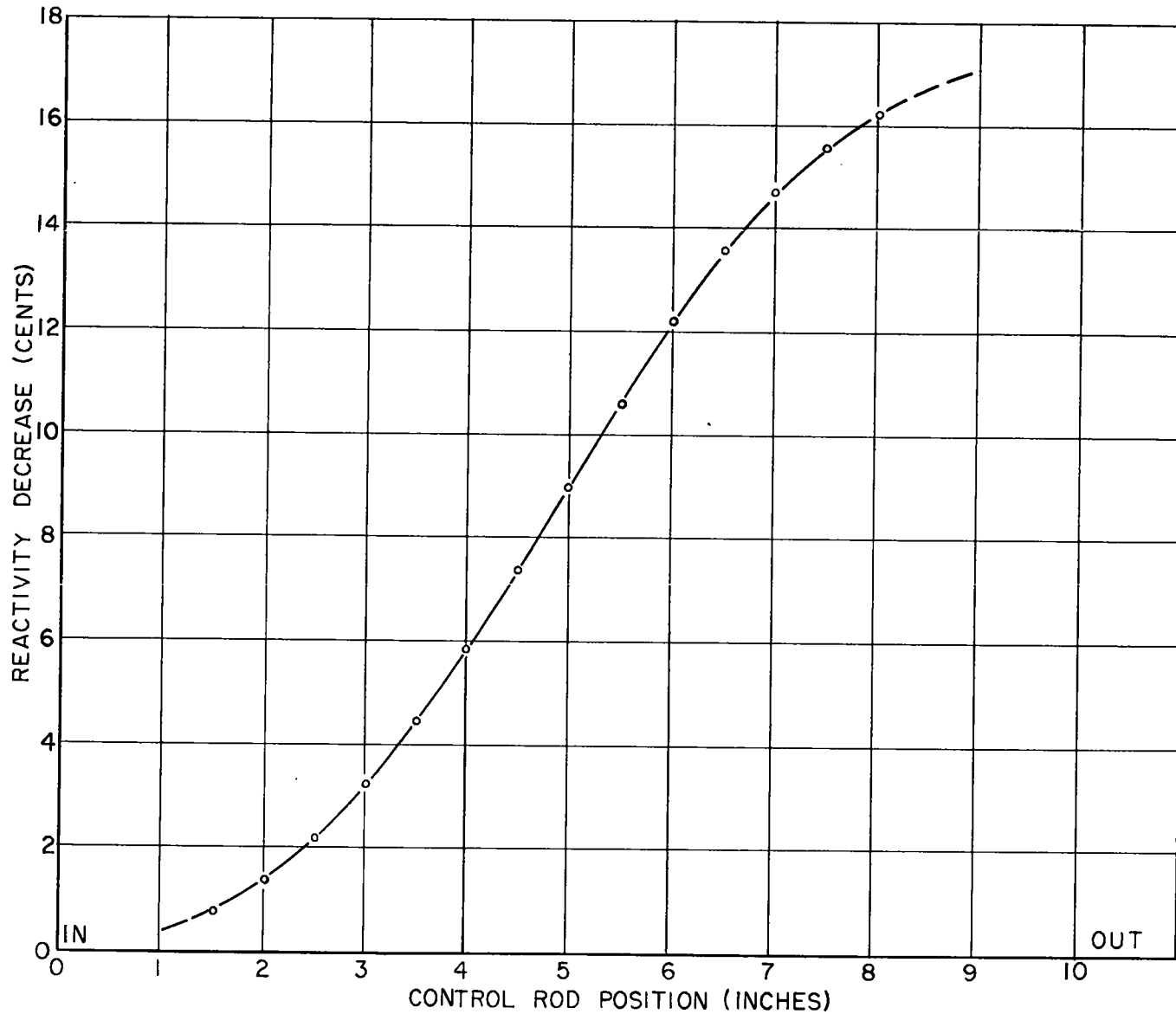
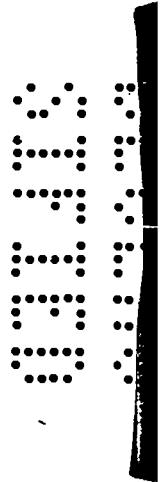



Fig. 14. Control rod calibration curve for the oralloy-tuballoy assembly.



SECRET

31

2.2 Other Typical Critical Assemblies on Topsy⁽¹⁾

2.2.1 Oralloy-Nickel Assembly. In one assembly, the tuballoy pieces of the nuclear assembly on Topsy were reproduced with commercial Type "A" (99.4% + Co) nickel, machined to the same dimensions and tolerances as specified for the tuballoy assembly. Critical mass determinations were made (Table 1) and the assembly was operated at delayed critical to permit investigation of its nuclear behavior under these conditions.

2.2.2 Oralloy Cores of Various Densities and Concentrations (Ref. 4). Using an 8 inch thick tuballoy tamper, oralloy cores of various concentrations and densities are stacked in the inner can to obtain a series of measurements relating critical mass and oralloy density and concentration. For low concentrations, the pseudospherical cores are built up with tuballoy and oralloy blocks in the correct proportions. Low densities are obtained by leaving 1/2 inch cubic voids, produced by thin-walled aluminum cylinders, appropriately spaced throughout the core assembly.

Critical mass measurements are made in each case by first taking central source multiplications up to approximately 100. The cores are then stacked on up to delayed

⁽¹⁾ See also: Paxton and Linenberger, "Polythene-25 Critical Assembly and Neutron Distribution Studies," LA-749 (1949).

TABLE 1
TOPSY DELAYED CRITICAL MASS DATA

Reference	Core			Tamper			Critical mass (kg)
	Material	ρ (gm/cm ³)	Shape	Material	ρ (gm/cm ³)	Shape	
LA-1114 (1950)	Oy (94%)	18.7	pseudosphere	Tu	~ 19.0	pseudosphere ~ 11" thick	17.2
LA-1251 (1951)	Oy (67.6%)	18.75	"	"	"	pseudosphere 8 1/2" thick	30.73
"	Oy (47.3%)	18.8	"	"	"	pseudosphere 7-3/4" thick	57.23
"	Oy (94%)	15.8 1/2" cubes at 18.7	"	"	"	pseudosphere ~ 8-3/4" thick	21.34
"	Oy (94%)	9.35 1/2" cubes at 18.7	"	"	"	pseudosphere 7-1/4" thick	30.24
LA-1114 (1950)	Oy (94%)	18.7	"	Ni	8.35	pseudosphere ~ 8-3/4" thick	21.20
Not yet reported	Pu alloy	15.7	sphere (central source cavity-0.4" diam.)	Tu	~ 19.0	pseudosphere ~ 9 1/2" thick	5.81

APPROVED FOR PUBLIC RELEASE

APPROVED FOR PUBLIC RELEASE

01110

critical, thus permitting determination of the exact critical mass without extrapolation. Core densities range from 50 to 100% of normal, and concentrations vary from 47 to 94%.

2.2.3 Plutonium-Tuballoy Assembly. Only minor modifications are needed to adapt a plutonium core to the Topsy tuballoy tamper assembly. The core consists of a four-piece, true, spherical ball, a protective tuballoy shell, and 10 plutonium mass adjustment buttons, all of which are carried on the lift. The 1/8 inch thick shell contains cavities for holding the close-fitting buttons next to the core, thus providing reactivity adjustments for different operations. The assembly has been operated at delayed critical to obtain critical mass information, neutron distributions, and measurements of alpha by the Rossi method.

33 01110

A large black rectangular redaction mark covers the text in this section. The redaction is positioned below the page number and above the footer.

•••••

3. References

1. V. Josephson, "Safety Tests on Hand Stacking of U-235 Cubes," LAMS-786 (1948).
2. Orndoff and Johnstone, "Time Scale Measurements by the Rossi Method," LA-744 (1949).
3. Paxton, "Effects of Foreign Materials on the Topsy Metal Assembly," LAMS-1154 (1950).
4. Orndoff, Paxton, and Hansen, "Critical Masses of Oralloy at Reduced Concentrations and Densities," LA-1251 (1951).

0110
[REDACTED]

03713

REPORT LIBRARY
REC. FROM *Da*
DATE *10-6-53*
RECEIPT

03713
03713