

LA-UR--91-2067

DE91 014599

**TITLE MUON-CATALYZED FUSION THEORY**

**AUTHOR(S) Melvin Leon**

**SUBMITTED TO Proceedings of the Workshop on  
"The Future of Muon Physics,"  
Heidelberg, Germany  
May 7-10, 1991**

**DISCLAIMER**

JUL 0 1991

This report was prepared as an account of work sponsored by an agency of the United States Government. Neither the United States Government nor any agency thereof, nor any of their employees, makes any warranty, express or implied, or assumes any legal liability or responsibility for the accuracy, completeness, or usefulness of any information, apparatus, product, or process disclosed, or represents that its use would not infringe privately owned rights. Reference herein to any specific commercial product, process, or service by trade name, trademark, manufacturer, or otherwise does not necessarily constitute or imply its endorsement, recommendation, or favoring by the United States Government or any agency thereof. The views and opinions of authors expressed herein do not necessarily state or reflect those of the United States Government or any agency thereof.

By acceptance of this article the publisher recognizes that the U.S. Government retains a nonexclusive, royalty-free license to publish or reproduce the published form of this contribution or to allow others to do so for U.S. Government purposes.

The Los Alamos National Laboratory requests that the publisher identify this article as work performed under the auspices of the U.S. Department of Energy.

**MASTER**

**Los Alamos** Los Alamos National Laboratory  
Los Alamos, New Mexico 87545

# MUON-CATALYZED FUSION THEORY

M. Leon

Los Alamos National Laboratory

Los Alamos, NM 87545, USA

## ABSTRACT

Some topics in muon-catalyzed fusion theory are discussed: Resonant formation of  $dd\mu$  molecules appears to be well understood, with good agreement so far between theory and experiment. The situation for resonant  $dt\mu$  formation is much less clear, because of the more complicated kinetics, the apparent three-body effect, and the evident need to treat thermalization and molecular formation together to compare theory and experiment. Recent theoretical progress in  $pd\mu$  fusion by Friar et al. has resolved a serious discrepancy in the Wolfenstein-Gershtein effect, i.e., the increase in  $pd\mu$  fusion yield with increased deuterium fraction.

## 1. INTRODUCTION

$\mu$ CF theory encompasses the whole catalysis cycle, sketched in Fig. 1 for deuterium-tritium targets. Steps in the cycle include the slowing to very low (eV) energies through ionization of the target molecules, the transition from free to bound states, deexcitation of the initially formed highly excited muonic hydrogen atoms, transfer of the muon from lighter to heavier hydrogen isotopes (because of the reduced-mass effect), which can take place from excited or ground states, formation of the muonic molecular ion and its deexcitation, and finally nuclear fusion with the  $\mu^-$  either stuck to a fusion product or free to go around the cycle again. Lack of time prevents me from discussing all of these steps, so I will concentrate on the molecular formation step, in particular on the intricate and fascinating resonant molecular formation mechanism, first in general and then the particulars of the

two operative examples,  $dd\mu$  and  $dt\mu$  formation. Finally, I will discuss the new theoretical light shed on the oldest  $\mu CF$  reaction, that of  $pd\mu$ , and on the Wolfenstein-Gershtein effect, which was thought to be understood quite well nearly three decades ago but which became considerably more troublesome in recent years.

## 2. RESONANT MOLECULAR FORMATION

In the authoritative 1960 review article of Zeldovitch and Gershtein [1] we find the following paragraph:

### f) Formation of Mesomolecules

In the collision of free mesonic atoms with nuclei of hydrogen molecules, formation of mesomolecules is possible. In such a process the binding energy of the mesonic molecule can, in general, be given off either as radiation or to the electron of the hydrogen molecule, or finally to a neighboring nucleus in the molecule. The last of these mechanisms might play an important role in the formation of mesomolecules in excited states with a binding energy close to the dissociation energy of the hydrogen molecule. Since, however, there are no such levels in mesomolecules (cf. Table 3), this mechanism need not be considered.

To explain the unexpectedly large and temperature-dependent  $dd\mu$  molecular formation rate  $\lambda_{dd\mu}$ , Vesman in 1967 [2] postulated that there *must* exist such a state in the  $dd\mu$  system, with binding energy less than the  $D_2$  dissociation energy! L. I. Ponomarev and collaborators then set to work to determine theoretically whether such a state actually exists, developing for this purpose what they call the "adiabatic expansion" (which others call the "method of perturbed stationary states"). After a decade of effort, the "School of Ponomarev" had progressed sufficiently to conclude that the angular momentum  $J = 1$ , vibrational quantum number  $v = 1$  state of  $dd\mu$  is bound by about 2 eV, and furthermore the corresponding state in the  $dt\mu$  muonic molecule is bound by only about 1 eV [3,4]. On the basis of these results, Gershtein and Ponomarev in 1977 published a Physics Letter

[5] pointing out that (1) the Vesman idea appeared to be the correct explanation of the  $dd\mu$  results, and (2) for  $dt\mu \sim 10^2$  fusions per muon are expected! This prediction of  $\sim 100$  fusions/ $\mu^-$  did much to revive interest in  $\mu$ CF.

In recent years, variational calculations have overtaken in precision the adiabatic expansion in determining the nonrelativistic point Coulomb binding energies of the various muonic molecule systems; results quoted in a recent review [6] are displayed in Table 1. Corrections to these energies from the hyperfine interaction, relativity and QED, nuclear electromagnetic structure, etc., are important for the critical  $(J, v) = (1, 1)$  states of  $dd\mu$  and  $dt\mu$ , and are shown in Table 2.

The energies of these loosely bound states, along with the excitation energies of the compound molecule formed in the resonant reaction

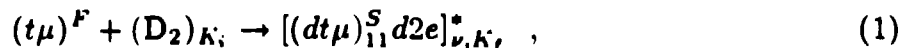

determine the resonance energies  $\epsilon_r$ . Here  $K_i$  and  $K_f$  are the rotational quantum numbers of the initial  $D_2$  and final compound molecule (or *complex*)  $[ ]^*$ , and  $\nu$  the  $[ ]^*$  vibrational quantum number (initial  $D_2$   $\nu = 0$ ), while  $F$  and  $S$  denote the  $t\mu$  and  $dt\mu$  hyperfine states. The rate for this resonant molecular formation can be written

$$\lambda_{mf} = N_0 \sum_{i,f} W_{K_i}(T) \int |M_{fi}|^2 2\pi \delta(\epsilon - \epsilon_r) f(\epsilon, T) d\epsilon , \quad (2)$$

where  $W_{K_i}(T)$  is the probability of initial rotational state  $K_i$  at temperature  $T$ ,  $M_{fi}$  the transition matrix element,  $\epsilon_r$  the resonance energy (which, of course, depends on  $K_i$ ,  $K_f$ ,  $\nu$ ,  $F$ , and  $S$ ), and  $f(\epsilon, T)$  the distribution of kinetic energy in the collisional center of mass (the Maxwell distribution for thermalized  $t\mu$ 's).

The pioneering calculation for the  $\lambda_{mf}$  was given by Vinitzky et al. in 1978 [7]. Subsequently, Lane [8] pointed out the importance of back decay, Leon [9] emphasized the need to include the plane-wave factor in  $M_{fi}$ , Cohen and Martin [10] showed how to include the effect of electron screening, and Menshikov and Faifman [11] stressed that undistorted

wave functions need to be used in  $M_{fi}$ . Either the *post* or *prior* form of the interaction can be used, but except for Lane [12] the *post* form is the choice made; recently Faifman et al. [13] stressed its advantages. Here

$$H' = \bar{d} \cdot \bar{E} \quad , \quad (3)$$

where  $\bar{d}$  is the dipole operator of the  $d\mu$  system and  $\bar{E}$  the electric field at its c.m. from the spectator nucleus plus electrons. The dipole interaction, Eq. (3), takes the  $S$ -state  $t\mu + d$  system to the  $J = 1$   $d\mu$  state. However, the  $t\mu + D_2$  system has an orbital angular momentum  $L$ , so that

$$\bar{L} + \bar{K}_i = \bar{J} + \bar{K}_f \quad , \quad (4)$$

with  $J = 1$ . Normally  $L = 0$  is dominant, so that  $K_f = K_i \pm 1$ .

Once the  $[(d\mu)d2e]^*$  complex is formed, back decay competes with deexcitation and fusion [8], so that for the *effective* molecular formation rate we have

$$\tilde{\lambda}_{mf} = \lambda_{mf} \cdot \frac{\tilde{\lambda}_f}{\tilde{\lambda}_f + \Gamma} \quad , \quad (5)$$

where  $\tilde{\lambda}_f$  is the sum of deexcitation and fusion rates and  $\Gamma$  is the back-decay rate (which in general is affected by collisions between the complex and the target molecules).

### 3. $dd\mu$ FORMATION

$\mu\text{CF}$  in pure  $D_2$  targets has provided a valuable verification of resonant muonic molecule formation processes and allowed detailed comparison between theory and experiment.

The  $F = \frac{3}{2}$  hyperfine state of  $d\mu$  lies 48.5 meV above the  $F = \frac{1}{2}$  state. The transition rate  $F \rightarrow F'$  is an important quantity, denoted by  $\lambda_{d\mu}^{FF'}$ ;  $\lambda_{d\mu}^{\frac{3}{2}\frac{1}{2}}$  is directly measured experimentally, as described below [14]. The resonant molecular formation rate  $\lambda_{dd\mu}^{F'S}$  involves vibration excitation  $\nu = 7$  for the complex. The much smaller nonresonant (Auger) rate is denoted by  $\lambda_{dd\mu}^{nr}$ . The  $(dd\mu)_{11}$  state is very long-lived, because the identity of the

deuterons implies that  $\Delta J = 1$  is accompanied by  $\Delta S_{dd} = 1$ , which is forbidden. Thus, the  $dd\mu$  is *stuck* in the  $J = 1$  state, where fusion is rather slow:  $\lambda_f \simeq 0.5 \times 10^9 \text{ s}^{-1}$  according to Bogdanova et al. [15]. As a result, back decay is actually dominant, and the effective molecular formation rate is [16]

$$\tilde{\lambda}_{dd\mu}^F = \lambda_{dd\mu}^{nr} + \sum_S \lambda_{dd\mu}^{FS} \frac{\tilde{\lambda}_f}{\tilde{\lambda}_f + \sum_{F'} \Gamma_{SF'}} . \quad (6)$$

Furthermore, resonant molecular formation followed by back decay contributes to hyperfine transitions, so for the effective HF transition rate we have [16,17]

$$\tilde{\lambda}_{d\mu}^{FF'} = \lambda_{d\mu}^{FF'} + \sum_S \lambda_{dd\mu}^{FS} \frac{\Gamma_{SF'}}{\tilde{\lambda}_f + \sum_{F''} \Gamma_{SF''}} . \quad (7)$$

The muon kinetics in a pure  $D_2$  target is shown in Fig. 2. Because the steady-state populations differ from the initial ones, *transients* appear in the detection of fusion neutrons as a function of time [14]. This is seen clearly in the AAS-PSI data shown in Fig. 3. The steep initial slope represents the emptying of the  $F = \frac{3}{2}$  state, where the effective molecular formation rate is large ( $\sim 4 \times 10^6 \text{ s}^{-1}$ ), into the  $F = \frac{1}{2}$  state where it is very small at low  $T$ . From this kind of data, the AAS-PSI group has been able to extract the individual molecular formation rates  $\tilde{\lambda}_{dd\mu}^F$ , shown in Fig. 4(a), and the hyperfine transition rate  $\tilde{\lambda}_{d\mu}^{\frac{3}{2} \frac{1}{2}}$ , shown in Fig. 4(b) [6]. The four hyperfine transitions that contribute are shown in Fig. 5.

The AAS-PSI data on  $\tilde{\lambda}_{dd\mu}^F$  can be fit using the beautiful *ab initio* calculations of Menshikov et al. [16], with only the resonance energy  $\epsilon_r$  and  $\tilde{\lambda}_f$  adjustable. However, the theoretical values of  $\tilde{\lambda}_{d\mu}^{\frac{3}{2} \frac{1}{2}}$  clearly exceed the experimental ones by a significant amount, as seen in Fig. 4(b); presumably the *nonresonant* contribution [18] is being overestimated. It should also be noted that  $\tilde{\lambda}_{dd\mu}^F$  is relatively insensitive to the magnitude of the matrix element  $|M_f|$ , since this enters in both the numerator and the denominator of the resonant term of Eq. (6).

It should be possible to extract even more information from the  $dd\mu$  system. by going to low target density  $\phi$  (measured relative to liquid  $H_2$  density). According to Menshikov et al. [16], for the complex equilibrated at the target temperature (20 K),

$$\Gamma \equiv \sum_{F'} \Gamma_{SF'} \simeq 1.5 \times 10^9 \text{ s}^{-1} \quad , \quad (8)$$

while Padial et al. [19] find for the rate for rotation relaxation of the  $K_f = 1$  complex,

$$\lambda_{1 \rightarrow 0} = 1.6 \times 10^{11} \phi \text{ s}^{-1} \quad . \quad (9)$$

Thus, for  $\phi \lesssim 1\%$ , the effect of the *initial* (time  $t = 0$ ) back-decay rate should become visible. Since we expect

$$\Gamma(t = 0) \simeq 2\Gamma(t = \infty) \equiv 2\Gamma \quad (10)$$

at this  $T$ , then for  $\phi \ll 1\%$   $\tilde{\lambda}_{dd\mu}^{\frac{3}{2}}$  should be a factor of two smaller, and the part of  $\tilde{\lambda}_{d\mu}^{\frac{3}{2}}$  due to molecular formation a factor of two bigger, than the  $\phi \gg 1\%$  values. Observation of this variation with  $\phi$  would allow direct comparison of  $\Gamma$  and  $\lambda_{1 \rightarrow 0}$ .

#### 4. $dt\mu$ FORMATION

For D/T targets, the kinetics, shown in Fig. 6, is, of course, much more complicated than for pure  $D_2$ . The steady-state cycling time can be written as a sum of the time the muon spends in the  $d\mu$  ground state, plus the times in the  $t\mu$  singlet and triplet ground states, so that for the steady-state cycling rate [9]

$$\lambda_c^{-1} = \frac{q_{1S}c_d}{\lambda_{dt}c_t} + \frac{\frac{3}{4}}{\lambda_{t\mu}^{10}c_t + \lambda_{dt\mu}^1c_d} + \frac{\frac{1}{4} + \frac{3}{4}\lambda}{\lambda_{dt\mu}^0c_d} \quad ; \quad (11)$$

here the branching ratio

$$\lambda \equiv \frac{\lambda_{t\mu}^{10}c_t}{\lambda_{t\mu}^{10}c_t + \lambda_{dt\mu}^1c_d} \quad , \quad (12)$$

and the molecular formation rates  $\lambda_{dt\mu}^F$  have contributions from both  $D_2$  and DT molecules.

At low temperature ( $\lesssim 200$  K), the only accessible resonances for thermalized  $t\mu$ 's are for  $F = 0$  on  $D_2$  [9]. Furthermore, for  $c_t \gtrsim 0.7$  the first two terms on the RHS of Eq. (11) should be negligible, so that

$$\lambda_c \propto c_{D_2} \quad . \quad (13)$$

A recent LAMPF experiment to test this relation found that it does *not* seem to hold [20,21]! The apparent contribution of DT molecules to molecular formation is thought to be due to the contribution of epithermal  $t\mu$ 's to steady-state molecular formation. (The role of epithermal molecular formation in giving rise to the transients seen for low density ( $\phi \simeq 1\%$ ) at PSI is well-established by now [6].) The  $dt\mu$  molecular formation rates are evidently so large as to compete with thermalization [22,23]! (Examples of rates calculated by Faifman et al. are shown in Fig. 7 [13].) Thus, all the elastic scattering cross sections and an intricate kinetics calculation are needed just to compare the theoretical molecular formation rates to the experimental cycling rates.

As if that were not enough complication, the (normalized) cycling rates show a density dependence evidently due to a three-body contribution to molecular formation; LAMPF and PSI data exhibiting this effect are shown in Fig. 8. The three-body effect is thought to be due to the unique property of singlet  $t\mu$  on  $D_2$  having its strongest transitions lying just below threshold (for  $\nu = 2$ ):  $0 \rightarrow 1$  has  $\epsilon_r \simeq -12$  meV,  $0 \rightarrow 2$  has  $\epsilon_r \simeq -2$  meV [6]. Menshikov and Ponomarev [24] have suggested that a spectator molecule picks up enough energy in a three-body collision,

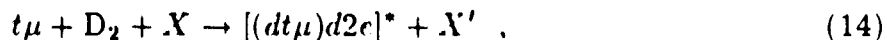

to move the  $0 \rightarrow 1$  transition into the physically accessible region. Starting with Petrov [25], several workers [26] have used the idea of *collisional broadening* and the replacement

$$\delta(\epsilon - \epsilon_r) \rightarrow \frac{1}{2\pi} \cdot \frac{\Gamma_r}{(\epsilon - \epsilon_r)^2 + (\Gamma_r/2)^2} \quad (15)$$

to calculate three-body molecular formation.



This replacement is equivalent to the *impact approximation* in the theory of spectral line broadening. However, as pointed out by Cohen and Leon [27], the slowness of the molecular collisions implies that the impact approximation is valid only for  $|\Delta\epsilon| \ll 1$  meV, and is therefore uninteresting!

Thus, we are left with the problem of how to calculate three-body molecular formation. Petrov and Petrov [28] have applied many-body perturbation theory to the problem, but had to replace the intermolecular potential by a hard-sphere interaction. Lane [29] attempted to extend the Baranger line-broadening theory to include the  $t\mu$  momentum, but again had to assume hard-sphere interactions. Leon [30] used a quasistatic treatment to show that the torque exerted on the complex by a neighboring molecule implied a significant configuration mixing of the  $K_f^-$  states of the complex, and hence a significant three-body effect. The lack of a complete and convincing method of calculation for three-body molecular formation remains a glaring deficiency of  $\mu$ CF theory.

In a somewhat different vein, Fukushima [31] has recently calculated resonant formation in *solid*  $D_2$ ; the three- or multi-body effect can be termed *phonon-assisted* molecular formation [32].

## 5. $pd\mu$ FUSION

$pd\mu$  fusion was first predicted long ago in 1947 by F. C. Frank [33], and observed a decade later by Alvarez et al. in a hydrogen bubble chamber [34]. The fusion reactions are

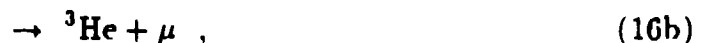

with (16a) predominant. The Wolfenstein-Gershtein (W-G) effect says that the HF quenching,  $(d\mu)^{3/2} \rightarrow (d\mu)^{1/2}$  (and therefore the deuterium fraction), affects the fusion yield [35]. That is, the statistical ratio of  $d\mu$  hyperfine populations leads to a statistical distribution among the  $S = 2,1,1',0$  HF states of the  $pd\mu$  molecule, while complete quenching of the

$(d\mu)^{3/2}$  state implies that only  $S = 1, 1'$ , and 0 are populated; the former have a larger fraction in the nuclear quartet state than the latter combination. Since the nuclear reaction rate from the quartet is expected to be smaller than from the doublet, quenching of the  $(d\mu)^{3/2}$  state increases the fusion rate and hence the fusion yield.

Cohen et al. in 1960 [36] estimated that the fusion rates satisfy

$$\lambda_{3/2}^{\gamma} \ll \lambda_{1/2}^{\gamma} ; \quad (17)$$

thereafter it became traditional to neglect  $\lambda_{3/2}^{\gamma}$  completely [4], although Carter in 1966 [37] warned that relation (17) was not at all justified. Thus, when Bleser et al. [38] in 1963 measured the W-G effect, they assumed  $\lambda_{3/2}^{\gamma} = 0$  and the then current theoretical value of the quenching rate  $\lambda_{d\mu}^{\frac{3}{2}\frac{1}{2}} \simeq 7 \mu s^{-1}$  [35]. These values lead to a predicted ratio of  $\gamma$ -yields at the different deuterium fractions of

$$\frac{Y_{\gamma} (25\%)}{Y_{\gamma} (0.7\%)} = 1.18 . \quad (18)$$

(Complete quenching of the  $F = 3/2$  state would give 1.8 for this ratio.) The measured value was 1.17(1), in essentially perfect agreement [38].

When Bertl et al. [39] remeasured the W-G effect twenty years later, they found

$$\frac{Y_{\gamma} (22\%)}{Y_{\gamma} (0.6\%)} = 1.172(5) \quad (19)$$

in excellent agreement with the Bleser et al. [38] experiment. However, in the meantime the value of the quenching rate  $\lambda_{d\mu}^{\frac{3}{2}\frac{1}{2}}$  had changed drastically: Matveenko and Ponomarev in 1971 [40] calculated  $46 \mu s^{-1}$  for this value, while even more significantly Kammel et al. [14] measured this rate as  $37(2) \mu s^{-1}$  using  $dd\mu$  fusion (see Fig. 3). With this latter value, the predicted W-G ratio becomes 1.50! To patch up this discrepancy, Bertl et al. [39] postulated that in addition to the quenching from collisions with deuterons (from exchange scattering), there is a contribution from collisions with protons, and adjusted its value to

give the observed W-G ratio. However, there is no mechanism known that can account for this process [41], so this solution was not very convincing.

In a more recent  $pd\mu$  experiment at PSI, Petitjean et al. [42] instead fitted the data by allowing  $\lambda_{3/2}^\gamma$  to differ from zero. Finally, Friar et al. [43] have very recently calculated the various  $pd\mu$  fusion rates using accurate three-nucleon wave functions derived with realistic potentials; not only do they find a significant value for  $\lambda_{3/2}^\gamma$ , but all the calculated fusion rates agree remarkably well with the experimental values—as shown in Table 3. Thus, after 30 years we can now say that the W-G effect is finally understood! (As it was thought to be in 1963.)

Lest I leave you with the impression that the  $pd\mu$  system is now completely understood, I mention that unexpected molecular effects,  $H_2 + D_2$  vs. HD, have been reported in the yields of the fusion  $\gamma$ 's [44]—these remain completely unexplained, and will doubtlessly be the subject of vigorous future investigation.

## 6. SUMMARY

The agreement between theory and experiment for resonant  $dd\mu$  formation is very encouraging, especially that for the magnitude of the resonance energies, which are determined to better than a meV, and the temperature dependence of the formation rates. For  $dt\mu$  formation the situation is much less clear, because of the more complicated kinetics and the need to treat thermalization and molecular formation together to compare theory with experiment, and the difficulty in calculating three-body molecular formation. In contrast,  $pd\mu$  fusion and the Wolfenstein-Gershtein effect now appear to be very well understood, while the reported dependence of  $pd\mu$  formation on the molecular structure of the target remains mysterious.

## ACKNOWLEDGEMENT

This work was performed under the auspices of the U.S. Department of Energy.

## REFERENCES

1. Zeldovitch, Ya. B., Gershtein, S.S.: *Usp. Fiz. Nauk* **71**, 581 (1960) [*Sov. Phys. Uspekhi* **3**, 593 (1961)].
2. Vesman, E. A.: *Pisma Zh. Eksp. Teor. Fiz.* **5**, 113 (1967) [*JETP Lett.* **5**, 91 (1967)].
3. Vinitsky, S. I. et al.: Preprint JINR P4-10336, Dubna (1976).
4. Gershtein, S. S., Ponomarev, L. I., in *Muon Physics*, ed. V. W. Hughes, C. S. Wu, New York: Academic (1975), **3**, 141.
5. Gershtein, S. S., Ponomarev, L. I.: *Phys. Lett.* **72B**, 80 (1977).
6. Breunlich, W. H. et al.: *Ann. Rev. Nucl. Part. Sci.* **39**, 311 (1989).
7. Vinitsky, S. I. et al.: *Zh. Eksp. Teor. Fiz.* **74**, 849 (1978) [*Sov. Phys. JETP* **47**, 444 (1978)].
8. Lane, A. M.: *Phys. Lett.* **98A**, 337 (1983).
9. Leon, M.: *Phys. Rev. Lett.* **52**, 605 (1984).
10. Cohen, J. S., Martin, R. L.: *Phys. Rev. Lett.* **53**, 738 (1984).
11. Menshikov, L. I. Faifman, M. P.: *Yad. Fiz.* **43**, 650 (1986) [*Sov. J. Nucl. Phys.* **43**, 414 (1986)].
12. Lane, A. M.: *J. Phys. B* **20**, 2911 (1987).
13. Faifman, M. P. et al.: *Muon Catal. Fusion* **4**, 1 (1989).
14. Kammel, P. et al.: *Phys. Rev. A* **28**, 2611 (1983).
15. Bogdanova, L. N. et al.: *Phys. Lett.* **115B**, 171 (1982); errata **167B**, 485 (1986).
16. Menshikov, L. I. et al.: *Zh. Eksp. Teor. Fiz.* **92**, 1173 (1987) [*Sov. Phys. JETP* **65**, 656 (1987)].
17. Leon, M.: *Phys. Rev. A* **33**, 4434 (1986).
18. Bracci, L. et al.: *Phys. Lett. A* **134**, 435 (1989).
19. Padial, N. T. et al.: *Phys. Rev. A* **37**, 329 (1988).
20. Jones, S. E., Anderson, A. N.: *Proc. Int. Symp. Muon Catal. Fusion  $\mu$ CF-89*, ed. J. D. Davis, RAL-90-022, 13 (1990).

21. Leon, M.: see Ref. 20, p. 23.
22. Cohen, J. S.: *Phys. Rev. A* **34**, 2719 (1976).
23. Jeitler, M. et al.: *Muon Catal. Fusion*, to be published.
24. Menshikov, L. I., Ponomarev, L. I.: *Phys. Lett.* **167B**, 141 (1986).
25. Petrov, Yu. V.: *Phys. Lett.* **163B**, 28 (1985).
26. Leon, M.: *Muon Catal. Fusion* **1**, 163 (1987); Petrov, Yu. V. et al.: *ibid.* **2**, 261 (1988); Menshikov, L. I.: *ibid.* **2**, 273 (1988); Menshikov, L. I.: Preprint IAE-4606-2. Moscow (1988); Lane, A. M.: *J. Phys.* **21**, 2159 (1988).
27. Cohen, J. S., Leon, M.: *Phys. Rev. A* **39**, 946 (1989).
28. Petrov, V. Yu., Petrov, Yu. V.: *Muon Catal. Fusion* **4**, 73 (1989).
29. Lane, A. M.: *J. Phys. B* **22**, 2817 (1989).
30. Leon, M.: *Phys. Rev. A* **39**, 5554 (1989).
31. Fukushima, K.: *Muon Catal. Fusion*, to be published; — see Ref. 20, p. 62.
32. Leon, M.: *Workshop on Fund. Muon Physics*, Los Alamos, New Mexico (1986), LA-10714-C.
33. Frank, F. C.: *Nature* **160**, 525 (1947).
34. Alvarez, L. W. et al.: *Phys. Rev.* **105**, 1127 (1957).
35. Gershtein, S. S.: *Zh. Eksp. Teor. Fiz.* **40**, 698 (1961) [*Sov. Phys. JETP* **13**, 488 (1961)].
36. Cohen, S. et al.: *Phys. Rev.* **119**, 384 (1960).
37. Carter, B. P.: *Phys. Rev.* **141**, 863 (1966).
38. Bleser, E. J. et al.: *Phys. Rev.* **132**, 2679 (1963).
39. Bertl, W. H. et al.: *Atomkernenerg. Kerntech.* **43**, 184 (1983).
40. Matveenko, A. V., Ponomarev, L. I.: *Zh. Eksp. Teor. Fiz.* **59**, 1593 (1970) [*Sov. Phys. JETP* **32**, 871 (1971)].
41. Cohen, J. S.: *Phys. Rev. A*, to be published.
42. Petitjean, C. et al.: See Ref. 20, p. 42.

43. Friar, J. L. et al.: *Phys. Rev. Lett.* **66**, 1827 (1991).
44. Aniol, K. A. et al.: *Muon Catal. Fusion* **2**, 63 (1988).

---

---

Table 1. Coulomb molecular binding energies in eV<sup>a</sup> (from Ref. 6).

---

$J, v$	$pp\mu$	$pd\mu$	$pt\mu$	$dd\mu$	$dt\mu$	$tt\mu$
0,0	253.15	221.55	213.84	325.07	319.14	362.91
0,1	—	—	—	35.84	34.83	83.77
1,0	107.27	97.50	99.13	226.68	232.47	289.14
1,1	—	—	—	1.97 <sup>b</sup>	0.66 <sup>c</sup>	45.21
2,0	—	—	—	86.45	102.65	172.65
3,0	—	—	—	—	—	48.70

---

<sup>a</sup> See [6] for references.

<sup>b</sup> The accurate energy is 1.9749 eV.

<sup>c</sup> The accurate energy is 0.6603 eV.

---

---

**Table 2.** Corrections (in meV) to the energies of the  $J = 1, v = 1$  states of  $dt\mu$  and  $dd\mu$  (from Ref. 6).

	$dt\mu^a$	$dt\mu^b$	$dt\mu^c$	$dd\mu^a$	$dd\mu^b$
Nuclear charge distribution	+13.3	+13.3	+10.4 <sup>d</sup>	-1.5	-2.1
Darwin-type corrections	-2.5	-2.4	-1.8	-0.9	← <sup>c</sup>
Relativistic mass corrections	-0.5	←		+0.4	←
Recoil corrections	+3.8	←	+2.7	+1.9	←
Vacuum polarization	+16.6	+16.61	+17.1	+8.7	+8.66
Deuteron polarizability	-2.2	←	←	-0.1	←
Finite size of muonic molecule	+1.2	+0.29 <sup>f</sup>	←	+1.0	+0.24 <sup>g</sup>
Nuclear strong interaction	$\lesssim 10^{-4}$	←	$\sim 10^{-4}$	$\lesssim 10^{-4}$	←
Lower (para) hyperfine state	+35.9	+35.9	←	+16.2	←
Total $\Delta\epsilon$	+65.6	+64.8	+62.4	+25.7	+24.3

<sup>a</sup> Most recent values of Bakalov and colleagues (see [6] for references).

<sup>b</sup> G. Aissing and H. J. Monkhorst (unpublished).

<sup>c</sup> Kamimura and M. Kamimura et al. (unpublished).

<sup>d</sup> Using the triton charge form factor of Juster et al.; with the triton form factor of Collard et al. used in the other calculations, the calculated value is +13.3 (M. Kamimura, private communication).

<sup>e</sup> Arrows indicate which value is included in the sum if not calculated.

<sup>f</sup> Scrinzi & Szalewicz.

<sup>g</sup> Estimated.



## FIGURE CAPTIONS

1. Simplified  $\mu\text{CF}$  cycle for a deuterium-tritium target (from Ref. 6).
2. Simplified  $\mu\text{CF}$  cycle in  $\text{D}_2$  (from Ref. 6).
3. Time spectrum of  $dd\mu$  fusion neutrons (from Ref. 6).
4. Results of PSI experiments on hyperfine effects. (a) Molecular formation rates, (b) hyperfine transition rates (from Ref. 6).
5. The hyperfine transitions contributing to  $dd\mu$  formation (from Ref. 17).
6. Simplified  $dt\mu$  cycle (from Ref. 6).
7.  $\lambda_{dt\mu}^F$  as functions of laboratory energy for  $T = 30$  K for  $\text{D}_2$  (upper) and  $\text{DT}$  (lower) targets (from Ref. 13).
8. Density dependence of normalized cycling rates  $\lambda_c$ ; (top) LAMPF, (bottom) PSI,  $T$  between 20 K and 45 K (from Ref. 6).

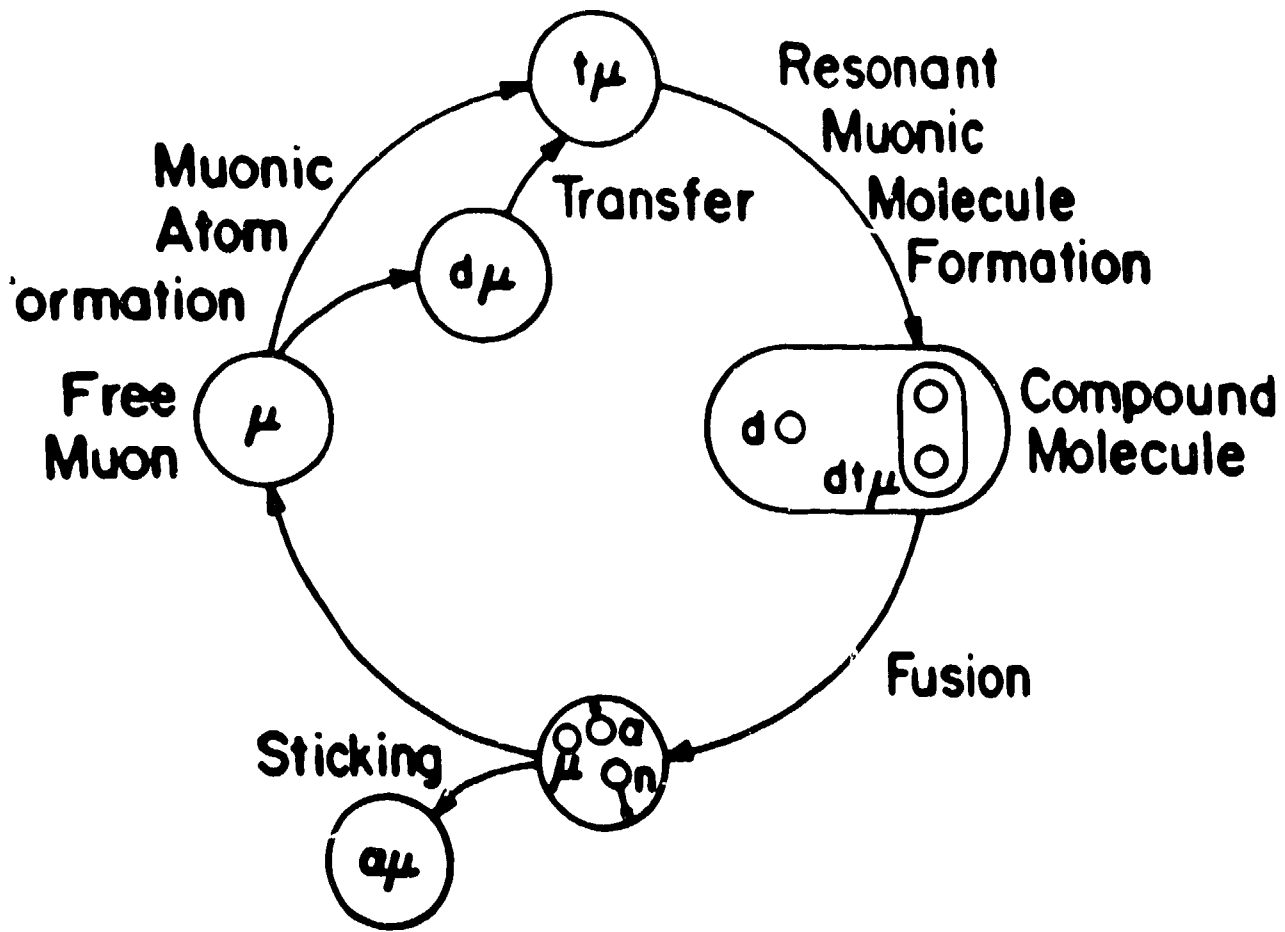

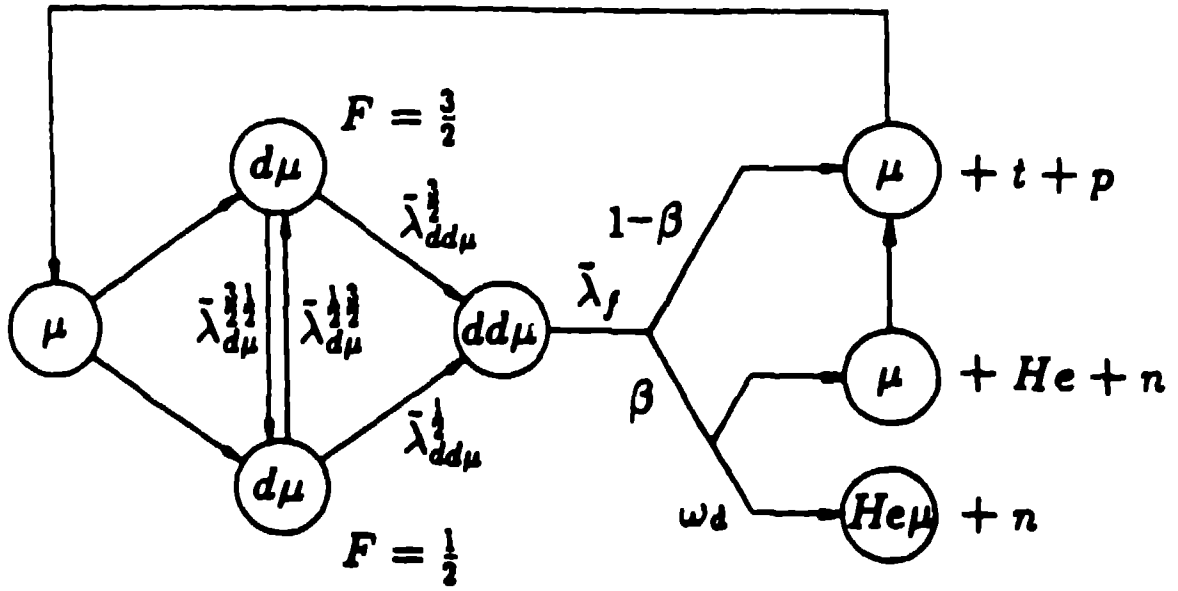

Fig 2.

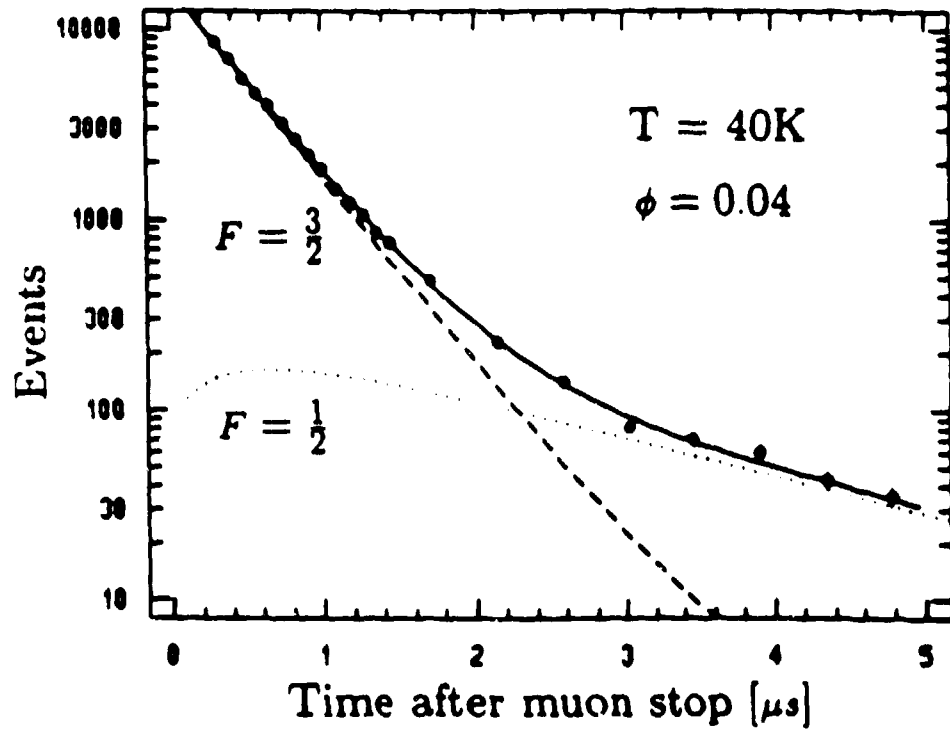

Fig. 5

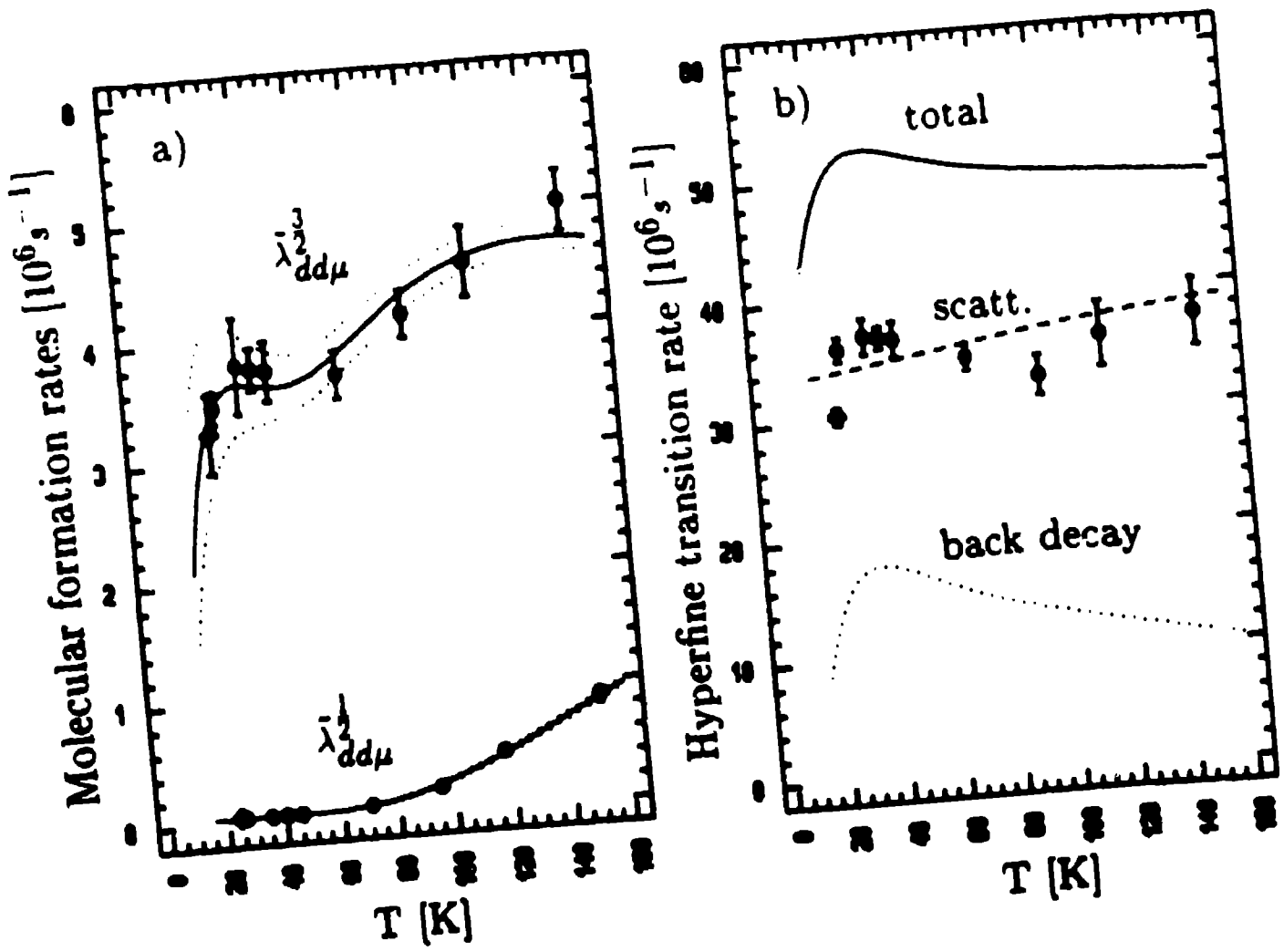

Fig. 4

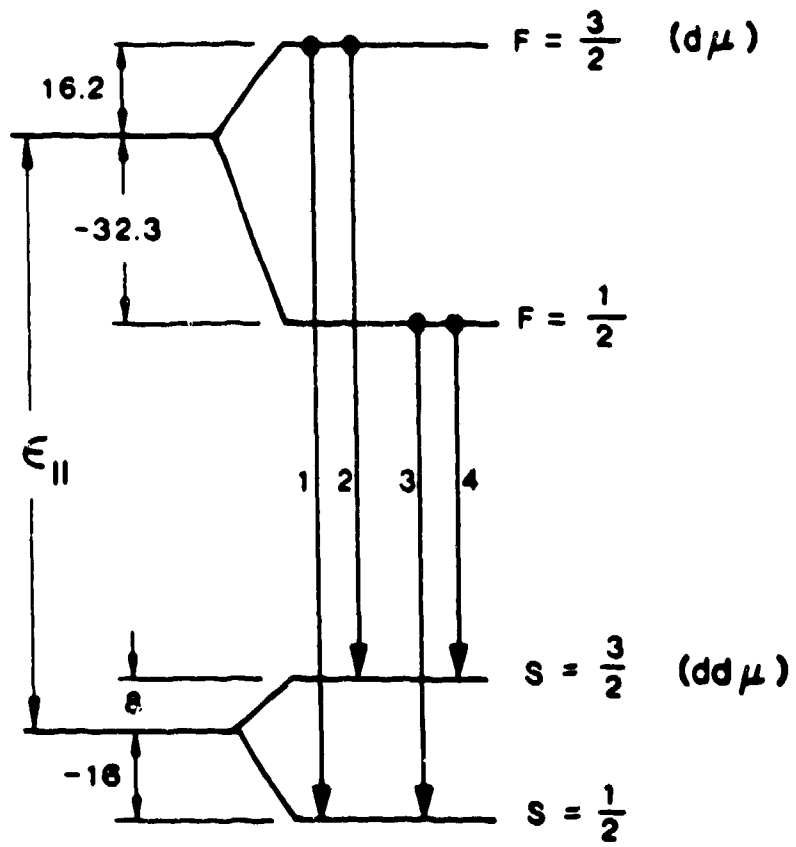

Fig. 5

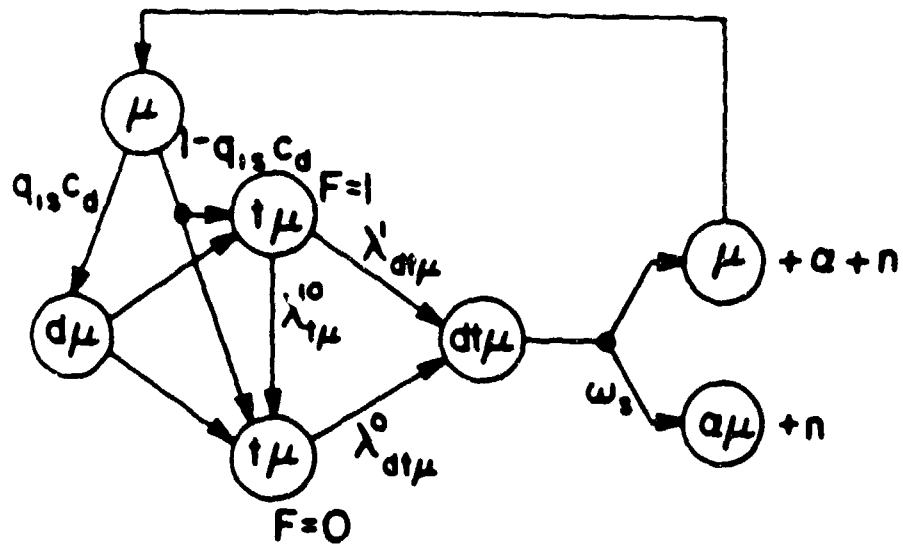

Fig. 6

