

# ACCELERATOR PRODUCTION OF TRITIUM

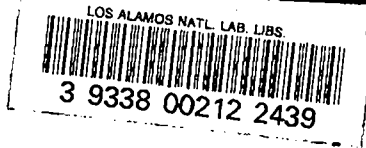

Presentation to

## Energy Research Advisory Board

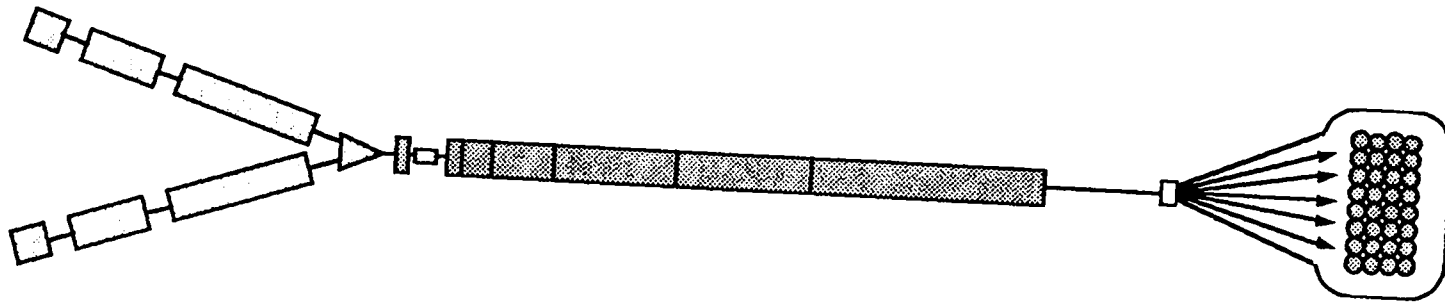

October 25, 1989

Los Alamos - Brookhaven National Laboratories

Los Alamos Report LA-UR 90-3651

*LA-UR-90-3651  
C.1*

TITLE: **ACCELERATOR PRODUCTION OF TRITIUM**

AUTHOR(S): G. P. Lawrence



SUBMITTED TO: Presentation to Energy Research Advisory Board, DOE on October 25, 1989



By acceptance of this article, the publisher recognizes that the U.S. Government retains a nonexclusive, royalty-free license to publish or reproduce the published form of this contribution, or to allow others to do so, for U.S. Government purposes.

The Los Alamos National Laboratory requests that the publisher identify this article as work performed under the auspices of the U.S. Department of Energy.

---

Los Alamos

Los Alamos National Laboratory  
Los Alamos, New Mexico 87545

**ACCELERATOR PRODUCTION OF TRITIUM  
INSTITUTIONAL ISSUES**

**PRESENTED TO THE  
ERAB  
ACCELERATOR PRODUCTION OF TRITIUM  
PANEL**

by

**James F. Jackson  
Deputy Director  
Los Alamos National Laboratory**

October 25, 1989

*Los Alamos - Brookhaven*

## **WE SUPPORT THE NPR PROGRAM**

- **An assured tritium supply is essential.**
- **Reactors are the preferred approach for large scale tritium production.**
- **We generally concur with the 1988 ERAB assessment of reactor alternatives.**
- **We support the current DOE NPR acquisition approach.**



## WHY APT?

Because of the importance of an assured tritium supply, we believe it would be prudent to develop at least one non-reactor production technology. This would serve as a contingency in case institutional barriers ever preclude reactor production. Thus, we do not consider APT to be a competitor for the current NPR Program, but rather a complement to it.

## **APT CHARACTERISTICS**

- No fissile/fertile materials.
- Tritium target processing technology as close to Savannah River as possible.
- Large power requirements for goal production.

*Los Alamos - Brookhaven*

## WHAT ARE WE PROPOSING?

- That DOE fund a four-year phased development program.
- An accelerator front end capable of driving a partial goal system would be built.
- A firm technical basis for tritium target technology would be developed.
- This would provide the technical basis for constructing an APT production facility (partial to full goal amounts) if required.

## **WE BELIEVE THAT APT IS A CREDIBLE APPROACH**

- Builds on recent accelerator advances in SDI program, and expanding industrial base.
- Scoping study/pre-conceptual design completed (no show stoppers).
- Could demonstrate technology in about four years, and potentially deploy in about ten years.
- Estimated costs appear reasonable.

## **PERSPECTIVE**

- Only scoping and pre-conceptual design done to date.
- Very little external funding.
- Don't have all the answers.
- But, we have done enough to lead us to believe that the proposal is technically credible.

*Los Alamos - Brookhaven*

**APT**

**ACCELERATOR PRODUCTION  
OF TRITIUM  
(APT)**

---

**Presentation to the  
Energy Research Advisory Board  
25 October 1989**

**Richard J. Burick  
NPB Program Director  
Los Alamos National Laboratory**

*Los Alamos - Brookhaven*

**APT**

# LANL AND BNL CONCEPT FOR ACCELERATOR PRODUCTION OF TRITIUM (APT)

Agenda  
25 October 1989

---

<b>TIME</b>	<b>TOPIC</b>	<b>Speaker</b>
<b>2:45-3:00</b>	<b>Introduction/Laboratory position</b>	<b>Jim Jackson, LANL</b>
<b>3:00-3:45</b>	<b>Concept Overview Program Approach Development Team</b>	<b>Dick Burick, LANL</b>
<b>3:45-4:35</b>	<b>Accelerator System</b>	<b>Stan Schriber, LANL</b>
<b>4:35-5:30</b>	<b>Target System Balance of Plant</b>	<b>Jim Powell, BNL</b>
<b>5:30-5:45</b>	<b>Summary</b>	<b>Dick Burick, LANL</b>

*Los Alamos - Brookhaven*

**APT**

## **OBJECTIVE OF APT DEVELOPMENT PROGRAM**

---

- **Provide cost effective nonreactor backup option for production of up to —Kg/yr tritium**
  - **Structure program for early demonstration of critical technologies**  
**Provide go/no-go decision points for DOE**
- **Program structure can provide for subgoal quantities of tritium**

*Los Alamos - Brookhaven*



**APT**

## **WHY IS APT A VIABLE BACKUP OPTION?**

---

- **Concept is not new — studies in 1950's-1960's and early 1980's found concept feasible but technology for high-current accelerators lacking**
- **An aggressive SDIO neutral particle beam program (> \$500M) has provided new technology for APT**
  - **High-current ion sources**
  - **CW operation**
  - **Design codes**
  - **Increased efficiencies**

*Los Alamos - Brookhaven*

**APT**

## **DEVELOPMENT PROGRAM WILL REDUCE RISK TO PROCEED WITH APT OPTION**

- Staged construction of prototype accelerator "front-end"
- Off-line development of efficient rf klystrons
  - Electric power consumption major driver
- Subscale target experiments to confirm tritium production rates
  - Will provide materials damage information
- SDI funded NPB programs
  - Funnel technology
  - Controls/diagnostics

*Los Alamos - Brookhaven*

## Accelerator Production of Tritium Plant

Major operational requirements for the APT plant include target fabrication and processing, waste storage and disposal, and balance of plant utilities.

An electrical requirement of 900 MW is required to power the APT complex. The major electrical consumer in the APT is the rf power supplies and amplifiers. Forced draft cooling towers using water coolant are used to dispose of the APT system waste thermal heat generated by the complex.

Major materials used in target fabrication are lead, aluminum, stainless steel, and lithium aluminum. These materials, once irradiated, provide the most significant radioactive waste streams. However, the volume of these wastes are only 30 cubic meters per year.

# APT

## ACCELERATOR PRODUCTION OF TRITIUM PLANT

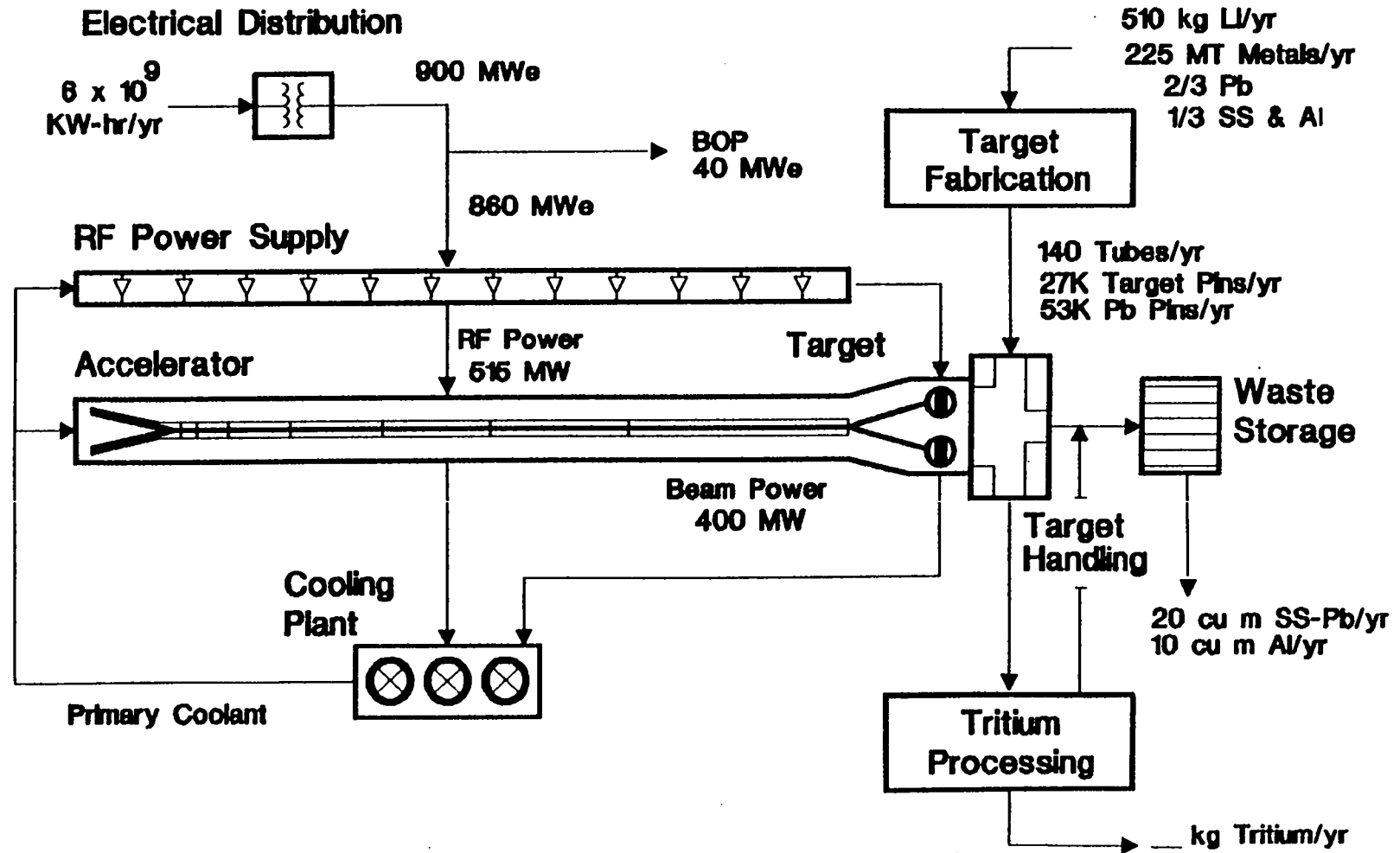

Los Alamos - Brookhaven

## Reference APT System for Goal Tritium Production

The reference APT system includes the accelerator, target lattice system, tritium processing, and supporting balance of plant. The 250 mA proton beam is accelerated to an energy of 1600 MeV and is uniformly defocused onto one of two operational target lattices, producing tritium. The target lattice is operated under low pressure and temperature conditions. The accelerator system is roughly two kilometers long and includes a low energy section that accelerates dual 125 mA beams to 20 MeV prior to funneling them together into the high energy beam. A majority of the length of the accelerator system is contributed by the high energy coupled cavity linac (CCL) section.

# APT

## REFERENCE APT SYSTEM FOR GOAL TRITIUM PRODUCTION

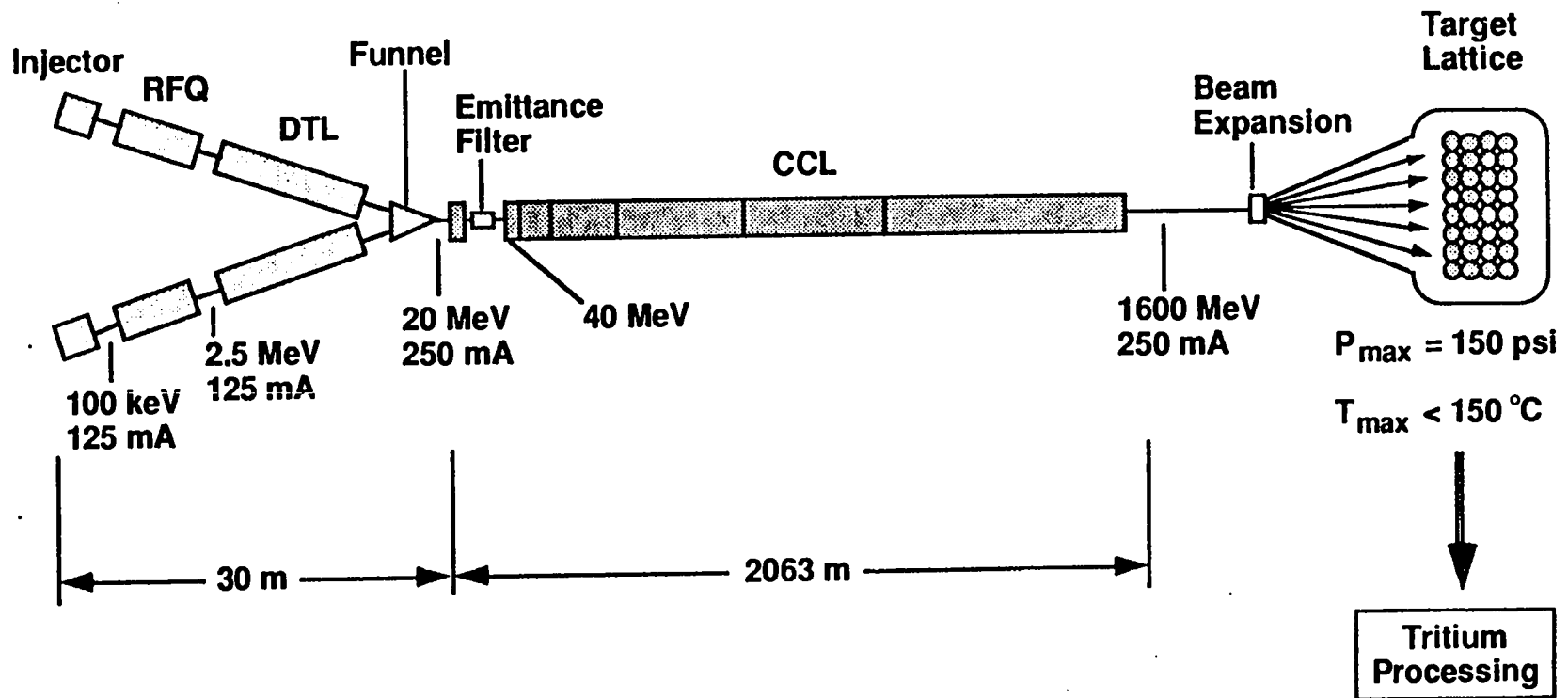

Los Alamos - Brookhaven

## Target Lattice is Simple Matrix of Lead and Enriched Lithium-Aluminum Rods

The target system consists of a matrix of primary target lead pins (the neutron converters) and of lithium-aluminum pins (the neutron absorbers which produce tritium). The pins are arranged in a matrix fashion and the interspace is used for cooling water which also acts as neutron moderator. This large matrix of about 60,000 pins is divided into 109 modules or pin assemblies, each mounted in a thin wall, vertical pressure tube to contain the water coolant. These pressure tubes are arranged into 7 banks of alternating rows of 16 and 15 tubes each, and the entire assembly is installed in a large vacuum vessel. The accelerator proton beam is defocused to uniformly irradiate a two-meter by four-meter area of the matrix.

The target lattice system conceptual design approach, besides satisfying and optimizing the physics of tritium production, is aimed at a very conservative, reliable, long-life system. Two identical target lattice systems will be constructed, providing minimum scheduled downtime for tritium removal, as well as improving system reliability.

Lead was selected as the material for the primary spallation neutron source because it is inexpensive, available in abundant supply, and is easy to use in the fabrication of pins. Furthermore, the neutronic, mechanical, and heat transfer properties of lead are well known.

Lithium-aluminum was selected as the tritium producing material because of the availability of a large data base developed for heavy water reactor (HWR) technology at the Savannah River Plant (SRP).

**APT**

# TARGET LATTICE IS SIMPLE MATRIX OF LEAD AND ENRICHED LITHIUM ALUMINUM RODS

**TARGET ASSEMBLY BEAM EXPANDER  
AND VACUUM VESSEL**

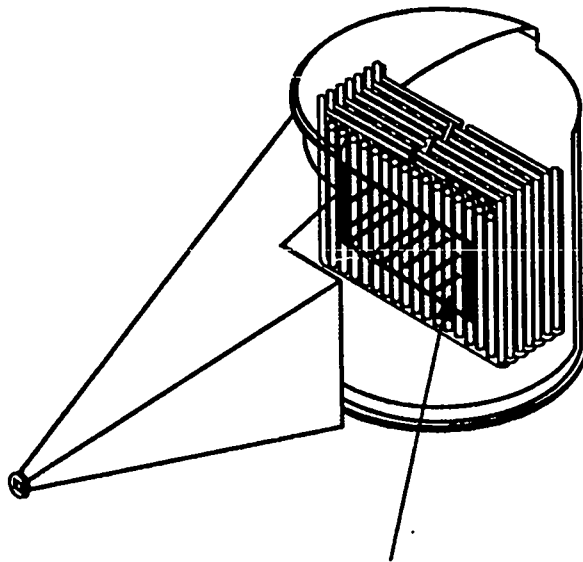

**2 x 4m Irradiated area**

**CROSS SECTION OF  
PRESSURE TUBE**

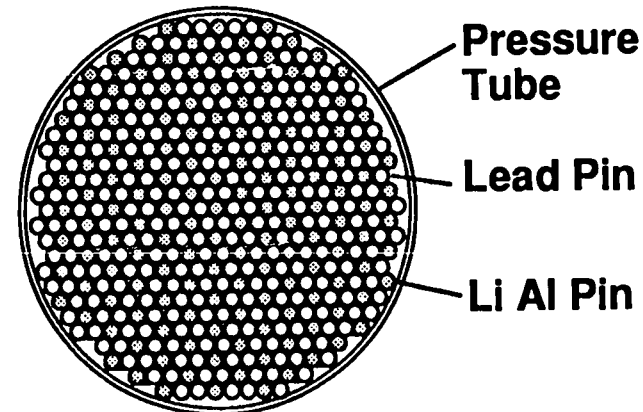

**Tube diameter 30 cm  
Pin diameter 1.1 cm  
No. of Pins 570  
Pb/Li Al Pins 2:1**

*Los Alamos - Brookhaven*



## Capital and Operating Costs are Driven by the Accelerator

In May 1989 an independent costing study for APT was conducted by Grumman Aerospace Corporation. Grumman performed a capital costing analysis based on a level-two WBS for the accelerator and lattice systems. Balance of plant costs for APT were developed by Westinghouse Hanford Company.

Grumman possesses a significant amount of accelerator design, fabrication, and integration experience from the neutral particle beam (NPB) program. They have fabricated accelerator hardware for the Beam Experiments Aboard a Rocket (BEAR) and Ground Test Accelerator (GTA) neutral particle beam programs at Los Alamos, and are the lead contractor on the Continuous Wave Deuterium Demonstrator (CWDD) program.

The results of the May costing analyses were used to develop the capital costs shown. Accelerator costs, particularly the coupled cavity linac section of the accelerator and its associated rf power, are cost drivers for the system. Operating costs are driven by the accelerator's use of electrical power. Lattice and accelerator operations contribute roughly one-third of the operational costs. Maintenance for the rf system is required to change out klystron tubes at a regular interval. Two-thirds of the life-cycle costs for APT are contributed by operational costs. All costs are presented in 1989 dollars.

**APT**

# Capital and Operating Costs are Driven by the Accelerator

## Reference Design Costs

**Total Capital**  
**\$3670 M**

**Total Operating**  
**\$425 M/yr**

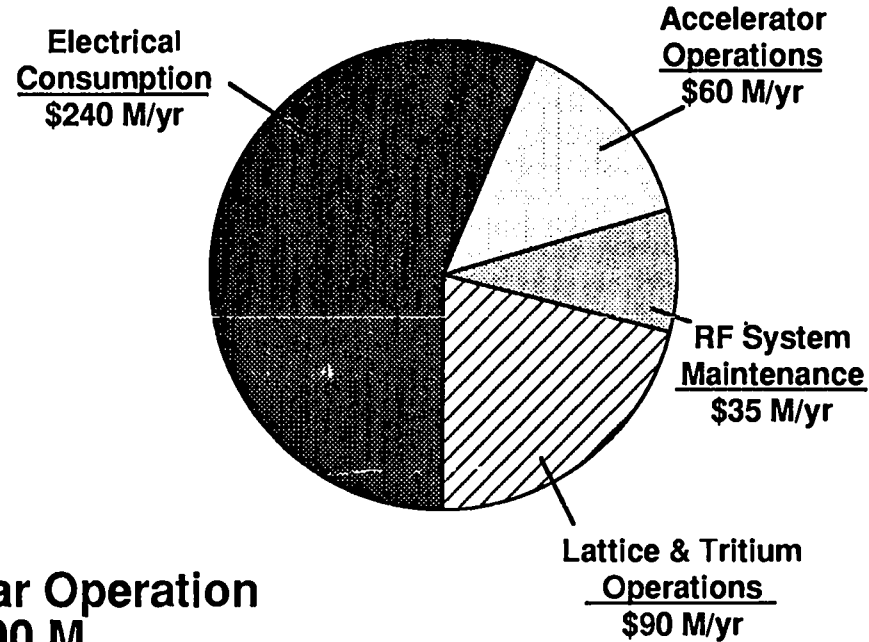
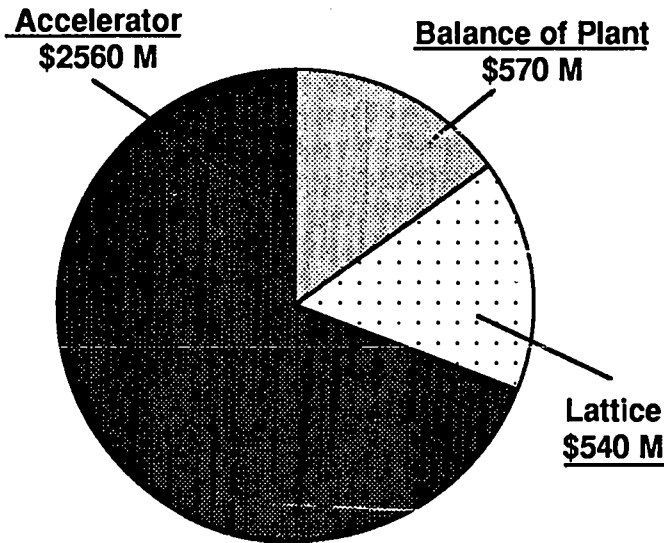

**Life Cycle Cost for 40 Year Operation**  
**5% discount rate = \$10,900 M**

*Los Alamos - Brookhaven*

## APT Development Program Schedule

The APT development program is directed to provide technical validation of the critical technologies over a four year period. At the end of this period, accelerator, rf source, beam expander, target/lattice, and tritium processing demonstrations will be completed, allowing a decision to proceed. System and technology tradeoff analyses will be performed to identify a preferred APT configuration.

Since the accelerator and target/lattice systems require the most comprehensive development, a staged approach has been selected. The accelerator front-end development includes a Stage I injector and RFQ demonstration, and a Stage II front-end demonstration up to 40 MeV with the emittance filter added. Both of these development stages would be completed at Los Alamos. The third stage of the accelerator development is the building up of the APT system to 160 MeV, which would be completed at the plant production site. RF source development would provide a prototype klystron tube at 700 Mhz from an industrial vendor who would be selected in a competitive procurement. The klystron tube would be tested at Los Alamos prior to the production of rf power stations for the APT Stage III system.

Target and lattice development would proceed in four stages. In the first stage, neutron yield experiments will be completed to verify neutron production predictions. Stage II will provide a target/lattice design with prototype component testing to validate design features. In Stage III materials testing and irradiation will be performed to verify tritium production rates at low current. The first three target/lattice stages will provide the necessary technology verification to proceed to Stage IV, which is the development prototype target/lattice system. Tritium processing development would be completed on a schedule consistent with the target/lattice developments described above.

# APT

## APT DEVELOPMENT PLAN

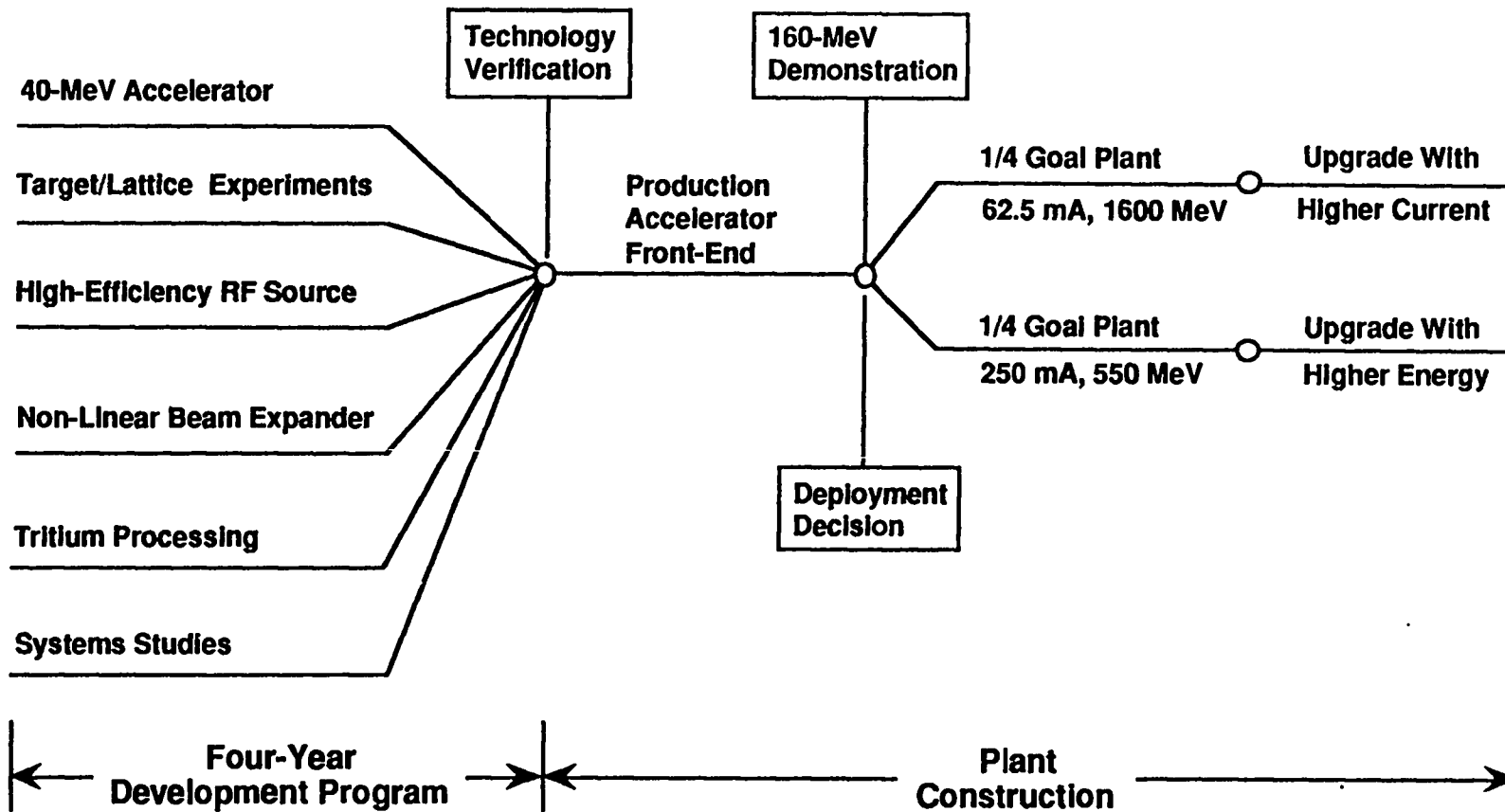

Los Alamos - Brookhaven

## APT Development Program Schedule

The APT development program is directed to provide technical validation of the critical technologies over a four year period. At the end of this period, accelerator, rf source, beam expander, target/lattice, and tritium processing demonstrations will be completed, allowing a decision to proceed. System and technology tradeoff analyses will be performed to identify a preferred APT configuration.

Since the accelerator and target/lattice systems require the most comprehensive development, a staged approach has been selected. The accelerator front-end development includes a Stage I injector and RFQ demonstration, and a Stage II front-end demonstration up to 40 MeV with the emittance filter added. Both of these development stages would be completed at Los Alamos. The third stage of the accelerator development is the building up of the APT system to 160 MeV, which would be completed at the plant production site. RF source development would provide a prototype klystron tube at 700 Mhz from an industrial vendor who would be selected in a competitive procurement. The klystron tube would be tested at Los Alamos prior to the production of rf power stations for the APT Stage III system.

Target and lattice development would proceed in four stages. In the first stage, neutron yield experiments will be completed to verify neutron production predictions. Stage II will provide a target/lattice design with prototype component testing to validate design features. In Stage III materials testing and irradiation will be performed to verify tritium production rates at low current. The first three target/lattice stages will provide the necessary technology verification to proceed to Stage IV, which is the development prototype target/lattice system. Tritium processing development would be completed on a schedule consistent with the target/lattice developments described above.

# APT

## APT DEVELOPMENT PROGRAM SCHEDULE

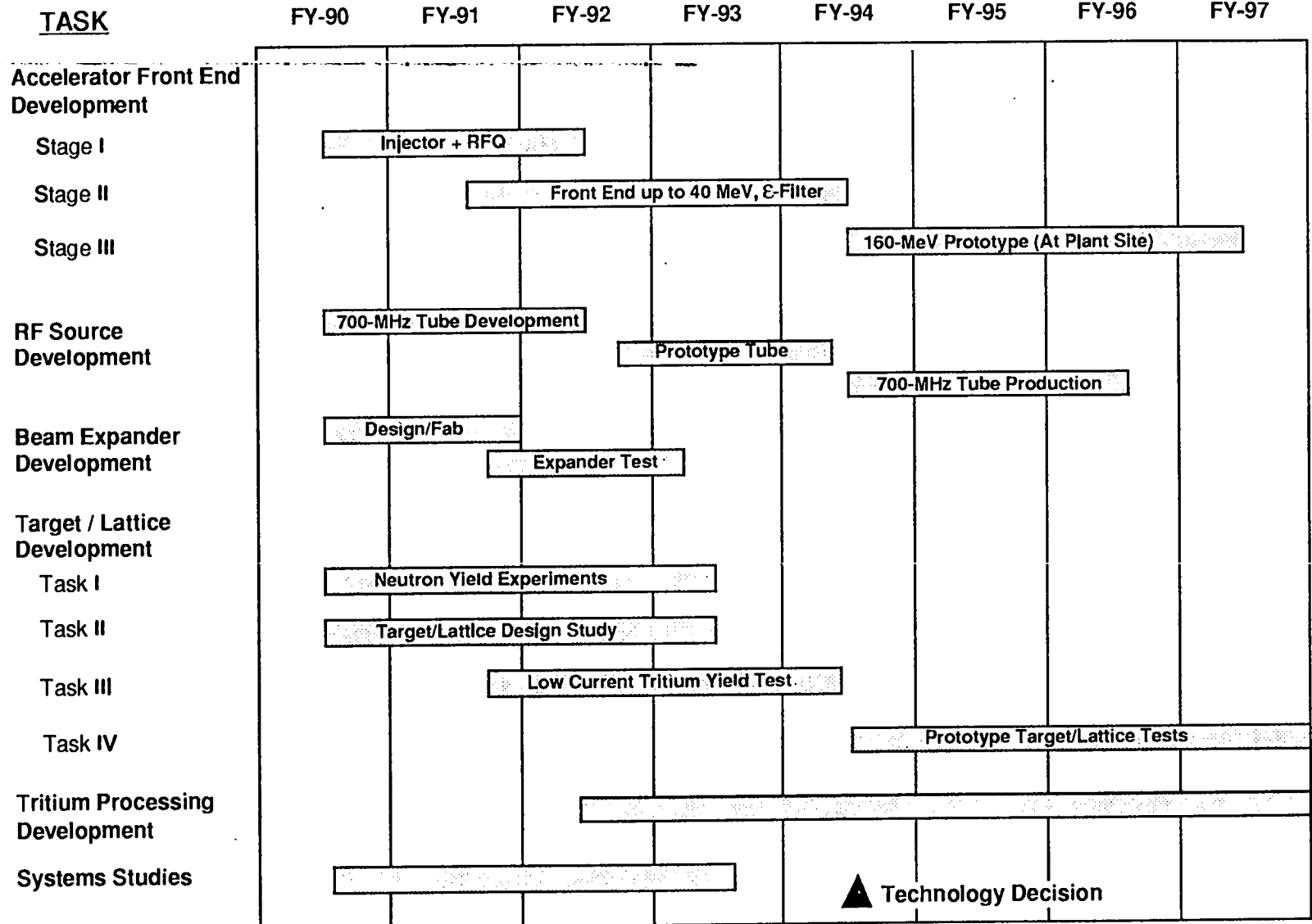

Los Alamos - Brookhaven

**APT****APT System Four Year Development Costs**

<b>Development Tasks</b>	<b>Cost, \$M</b>
<b>Accelerator &amp; RF System to 40 Mev</b>	
<b>Stage I - Injector/RFQ</b>	<b>5</b>
<b>RF Source Development</b>	<b>8</b>
<b>Stage II - DTL/CCL/Funnel</b>	<b>67</b>
<b>Target /Lattice Development</b>	
<b>Task I - Neutron Yield</b>	<b>15</b>
<b>Task II - Design</b>	<b>28</b>
<b>Task III - Production Test</b>	<b>10</b>
<b>Tritium Processing</b>	<b>10</b>
<b>Component Development &amp; System Studies</b>	<b>13</b>
<b>TOTAL</b>	<b>156</b>

*Los Alamos - Brookhaven*

## The Physics of APT

For protons above 50 MeV, the principal types of interactions with atoms are electron ionization-excitation and inelastic collisions with individual nucleons within the nucleus. This reaction process is usually called the "spallation-evaporation" or "intranuclear-cascade evaporation" process.

The spallation evaporation process results in protons, neutrons, or mesons escaping, or being "spalled-out" of the nucleus. The energy of the spallation process may be sufficient to induce further intranuclear cascades in other target nuclei. Thus, neutron multiplication occurs as a result of these intranuclear processes in the target material. Since high atomic mass nuclei will result in larger neutron yields than low mass nuclei, lead was selected as the target element of choice.

The yield of neutrons produced in the spallation-evaporation process has been measured and increases as a function of proton energy. Computational models for the spallation-evaporation process agree closely with measurements that have been made.

Neutrons produced by the spallation-evaporation process interact with a target matrix of lead pins, lithium-aluminum pins, and water coolant. Neutron interactions in the target matrix result in a slowing down of the neutrons, with the neutrons being either captured by Lithium-6 to produce tritium, or otherwise being lost.



# APT

## THE PHYSICS OF APT

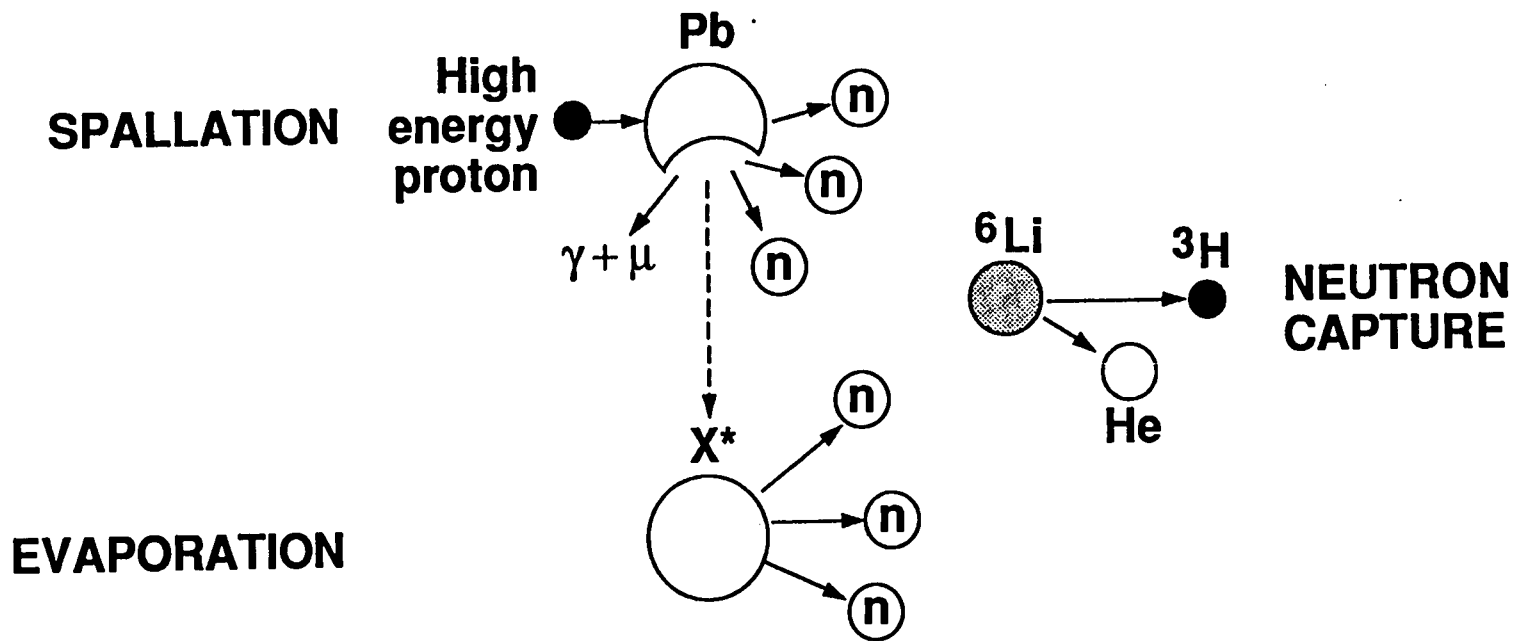

**APT**

## **THE NONREACTOR APT BACKUP OPTION HAS INHERENT SAFETY CHARACTERISTICS**

---

- **No pathways to criticality reaction**
- **No transuranic waste**
- **Target irradiation terminated < 1 ms, low after heat**
- **Low pressure/temperature target matrix**
- **Reduced levels of long-lived radioactive waste**

*Los Alamos - Brookhaven*

**APT**

## **KEY TECHNICAL ISSUES FOR ACCELERATOR SUBSYSTEM**

---

- **Reliability**
  - 75% plant factor, 40-year life
  - Ease of maintenance
  
- **Operability**
  - Control of beam will dictate type of maintenance
  - Accelerator start-up/shut-down
  
- **Efficiency**
  - Power conversion, about 900 MW<sub>e</sub> required for full goal plant

*Los Alamos - Brookhaven*

**APT**

## **CENTRAL ISSUE FOR APT ACCELERATOR**

- **Many of the required individual system components have operated near the APT point design specs — but:**
  - **An integrated system has never been operated at APT specifications to demonstrate performance, reliability, and operability**
- **Prudent, staged development program is required prior to APT backup commitment**

*Los Alamos - Brookhaven*

## **Staged Development of the Accelerator Front End**

A staged development program for the APT accelerator has been developed to address critical technology and production issues. Stages I and II provide prototype low energy hardware at Los Alamos to assess beam accelerator and control issues to 40 MeV. Stages III and IV provide for a staged construction of the APT system at the production site.

Stage I of the development plan is the design, fabrication, and testing of a 125 mA CW injector and RFQ. Reliable production and acceleration/bunching of the beam will be demonstrated in this stage to an energy of 2.5 MeV.

Stage II is the extension of the prototype beamline to 40 MeV, ending at an emittance filter and matching section. After exiting the RFQ, the beam is accelerated by a 20 MeV DTL into a funnel, and is then accelerated through the 20 MeV coupled cavity linac structure. Critical issues resolved in this stage include efficient DTL and CCL acceleration, a CW funnel beam control demonstration, and acceptable emittance control through the low energy accelerator. Beam loading in the CCL section of the accelerator will be validated. Staged construction of the APT production facility to 160 MeV is completed in Stage III of the program.

# APT

## STAGED DEVELOPMENT OF ACCELERATOR FRONT END

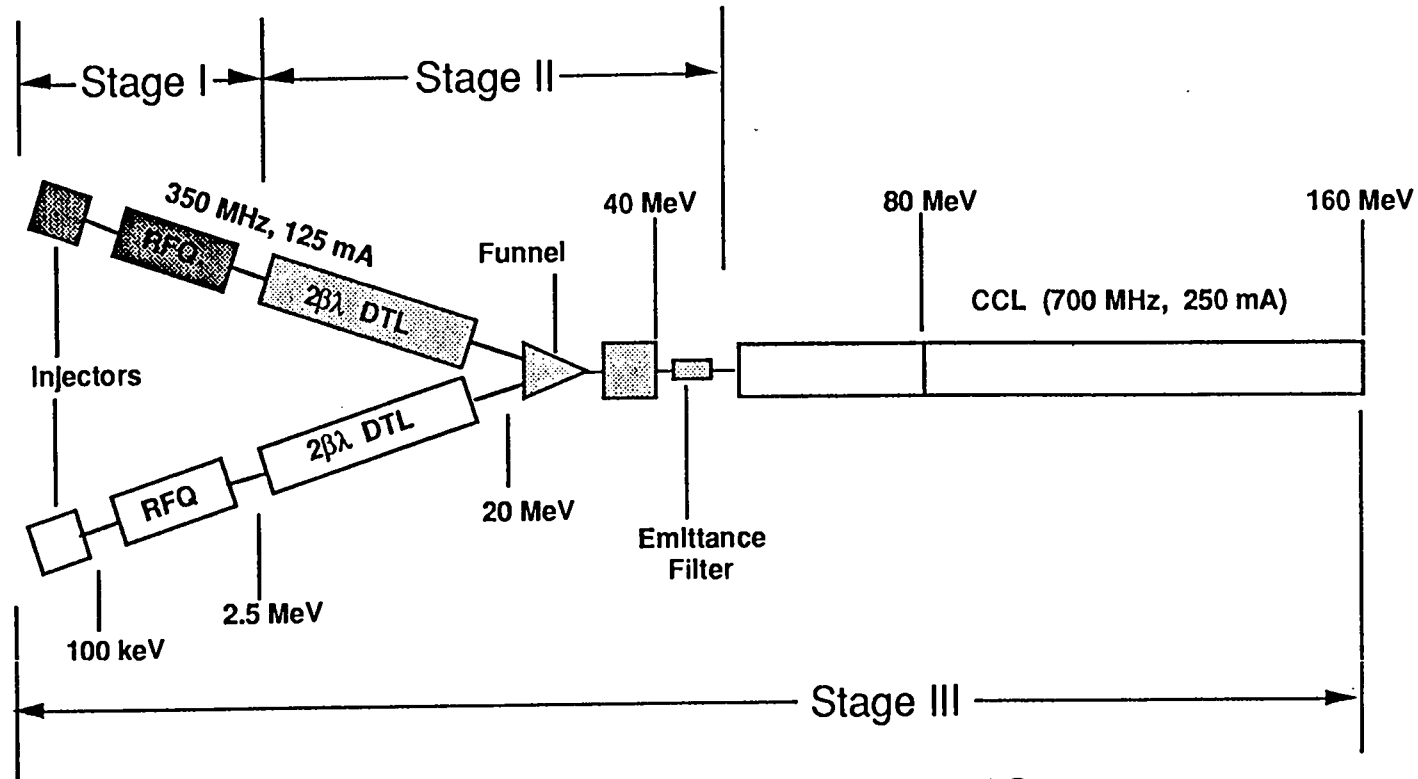

Stage	Energy	Current	RF Power	ΔCost
I	2.5 MeV	125 mA	0.7 MW	13 M\$
II	40 MeV	125 mA	12.1 MW	67 M\$
III	160 MeV	250 mA	64.2 MW	410 M\$

4-YEAR  
DEV. PLAN

Stage I costs include cost of RF-tube development.

Stage III would be built at the plant site, and could become part of the production accelerator.

Los Alamos - Brookhaven

## **Addition of CCL Provides Backup Options for Fractional Goal Production**

Once the low energy accelerator is commissioned in Stage III, a decision can be made to determine the optimum energy and current configuration of the plant. Since the APT system will be designed and constructed during Stage III with growth potential to full goal production, the system can be tailored during Stage IV to provide the fractional tritium production level desired.

Stage IV requires the addition of coupled cavity linac accelerator modules to bring the system to the desired accelerator energy. Additional rf power stations and system utilities are added, as well as the target lattice system, target fabrication, and tritium processing systems.

# APT

## ADDITION OF CCL PROVIDES BACKUP OPTIONS FOR FRACTION GOAL PRODUCTION

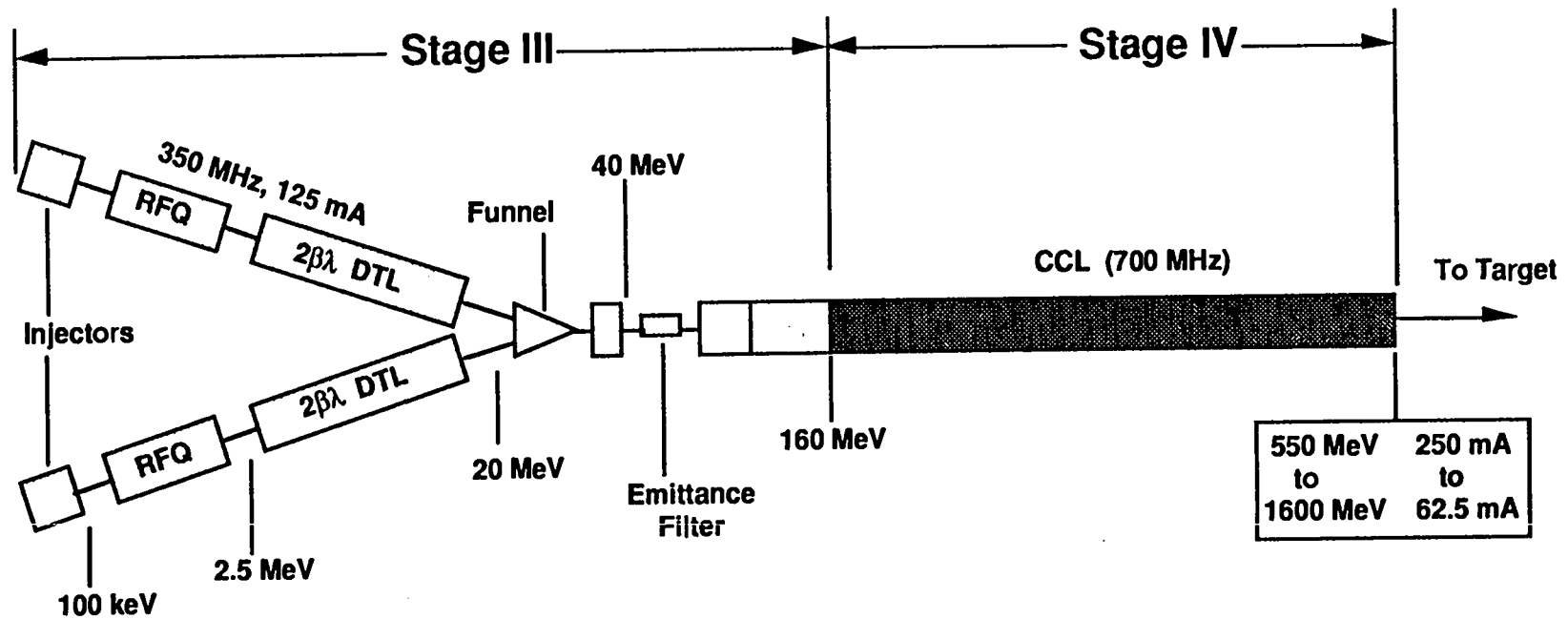

- From Stage III results, decide optimum energy/current combination for plant.
- Using existing (or retrofitted) front-end prototype, add CCL sections to 550 - 1600 MeV.

Los Alamos - Brookhaven



**APT**

## **RF KLYSTRON DEVELOPMENT STRATEGY**

- **rf power system is major cost of potential APT goal size plant (  $\approx$  1/3 plant cost )**
- **Tube efficiency will have major impact on power costs**
- **At present, major tube suppliers are not USA**
  - **Competitive development program will encourage US suppliers**
  - **Have received expression of interest from major US vendors**
  - **Estimated cost through prototype development about \$ 8 M**

*Los Alamos - Brookhaven*

**APT**

## **KEY TECHNICAL ISSUES FOR TARGET SUBSYSTEM**

- **Reliability**
  - Target materials damage
  - Deviations from existing SRP technology
- **Operability**
  - May need modified tritium processing facilities
  - Target integrity
- **Efficiency**
  - Neutron/proton production
  - Neutron capture efficiency

*Los Alamos - Brookhaven*

**APT**

## **TARGET LATTICE DEVELOPMENT PROGRAM**

- **For prototype of target lattice measure:**
  - **Tritium production yield and distribution**
  - **Neutron yield distributions**
  - **Prompt and decay heat**
  - **Radioactive product yields**
  - **Materials damage**
  
- **Facilities for program**
  - **BNL/AGS @ 1500 MeV**
  - **LANL/LAMPF @ 800 MeV**
  - **SRP processing facilities**
  - **BNL and LANL hot cell facilities**

*Los Alamos - Brookhaven*

**APT**

## **INFRASTRUCTURE EXISTS TO ADDRESS APT TECHNICAL ISSUES**

- **Accelerator**
  - Los Alamos
  - Chalk River
  - Grumman Aerospace
  - McDonnell Douglas
  - Other Accelerator Labs
  
- **RF Power**
  - Los Alamos
  - Westinghouse
  - Valvo
  - Thomson CSF
  - Varian
  - Litton
  
- **Target/BOP**
  - Brookhaven National Laboratory
  - Los Alamos
  - Savannah River Plant
  - Westinghouse Hanford
  - Other National Labs

*Los Alamos - Brookhaven*

**APT**

**Accelerator Production of Tritium (APT)  
Linear Accelerator System**

**Presentation to the  
Energy Research Advisory Board  
25 October 1989**

**S. O. Schriber  
Accelerator Technology Division Leader  
Los Alamos National Laboratory**

*Los Alamos - Brookhaven*

## Topics

- **Historical Perspective**
- **LAMPF to APT**
- **NPB Implications**
- **Accelerator Description**
- **Physics Design**
- **Issues**
  - **Codes**
  - **Beam Loss**
- **Development Items**
- **CW Technology Example**
- **Summary**

## Linear Accelerator Terminology

The difference between a pulsed rf linac and one operating continuous wave (cw) is shown schematically in the upper portion of the viewgraph. For APT it is easy to show that a cw machine is cheaper, more efficient, and has less beam loss. A pulsed machine would require more peak rf power for the higher-peak beam current. The pulsed rf linac would have higher beam loss associated with the many turn-on cycles of each macropulse and with the higher space charge in each beam bunch. Control would be more difficult because of the many turn-on transients (for each macropulse) with a heavily beam-loaded accelerator. Thermal cycling of the accelerator structures and the electrical stress induced for each macropulse would have to be accounted for in the design of the linac.

The rf waveform is shown for a small time interval (700 MHz basis) indicating that the proton beam comes out of the accelerator as a steady stream of bunches. Each bunch is within a stable region of the rf acceleration process—known as the bucket.

## RF Linear Accelerator — Some Terminology

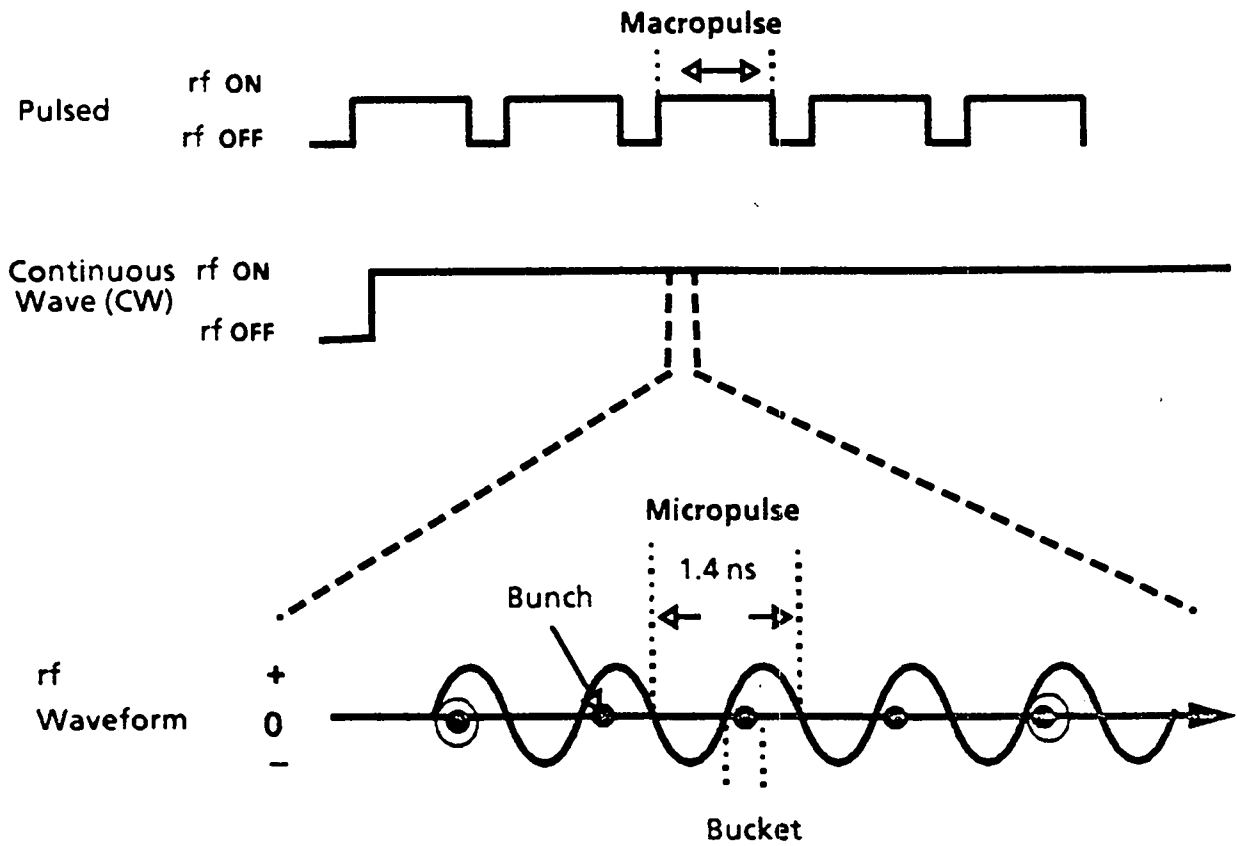

- Bunch experiences rf fields that provide acceleration and focusing
- APT uses every rf micropulse, unlike LAMPF where every fourth is used

— Beam starts off DC; it is adiabatically captured in rf fields and accelerated in bunches





## Emittance and Beam Distribution

Emittance, a description (phase space) of the collection of charged particles [as shown for one axis orthogonal to the direction of the beam motion in terms of bunch transverse emittance area], is a very convenient means to discuss, compare, calculate performance of, and design linear accelerators. The area enclosing the particles (one axis) gives a measure of their transverse thermal energy and how close the particles are to the beam longitudinal axis. Combining the two orthogonal emittances with a similar one for the longitudinal motion gives the 6-dimensional phase space volume—a value that remains constant as long as all particle interactions involve linear fields.

The lower figure shows the cross-section of a beam in one dimension—number of particles versus the distance from the beam axis. Distance from the axis is given in terms of the number of standard deviations,  $\sigma$ , for the particle distribution.

# APT

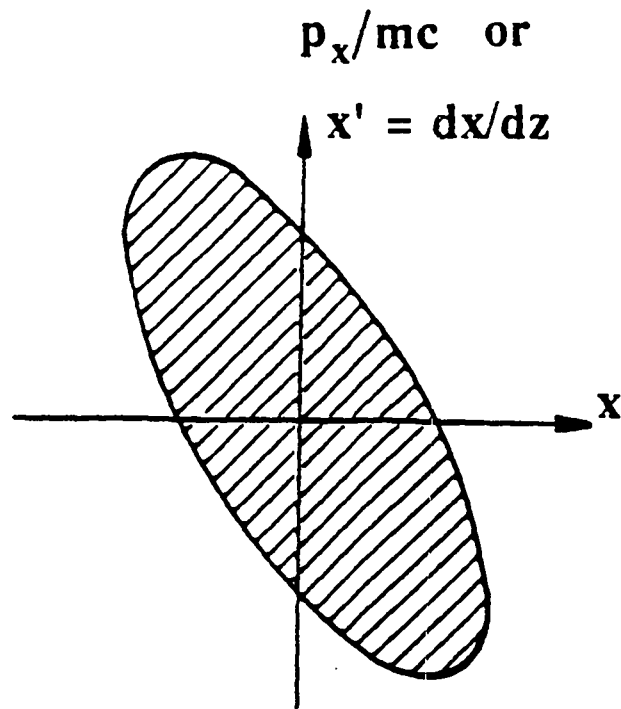

- Emittance is the phase-space volume occupied by the beam.
- In a real beam the outer boundary is not sharply defined but falls off gradually. This is the halo.

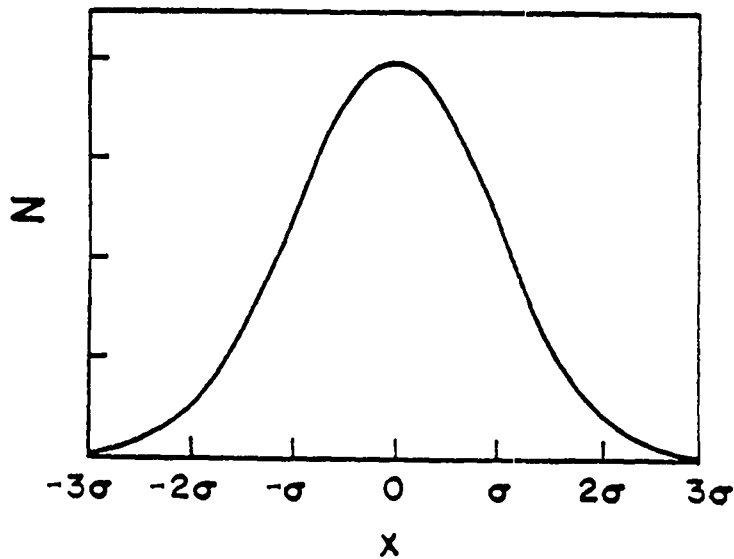

Los Alamos - Brookhaven

## Linear Accelerator Components

Shown are basic building blocks of any production linac such as LAMPF. Since the RFQ was not invented and demonstrated until the late 1970s, it was not used on LAMPF. Different rf accelerators are employed for different velocity regimes of the particles being accelerated—for reasons of efficiency, economy, and particle interactions, including focusing. Transitions between the different types of accelerators must be accomplished very carefully in order to not disrupt the beam.

The beam begins as DC extraction from a plasma source and is accelerated in a DC column to a moderate 100 keV energy. The beam is then matched to the RFQ where it is adiabatically captured, slowly given an rf nature, and accelerated to 2.5 MeV (the RFQ is basically an rf focusing/transport device that does some acceleration). The beam is then matched to a DTL, which accelerates the beam to 20 MeV. The velocity is now high enough to begin acceleration with the major portion of the accelerator—the CCL. Transport of the 1600 MeV beam to the target is done very carefully, to preserve good characteristics.

# APT

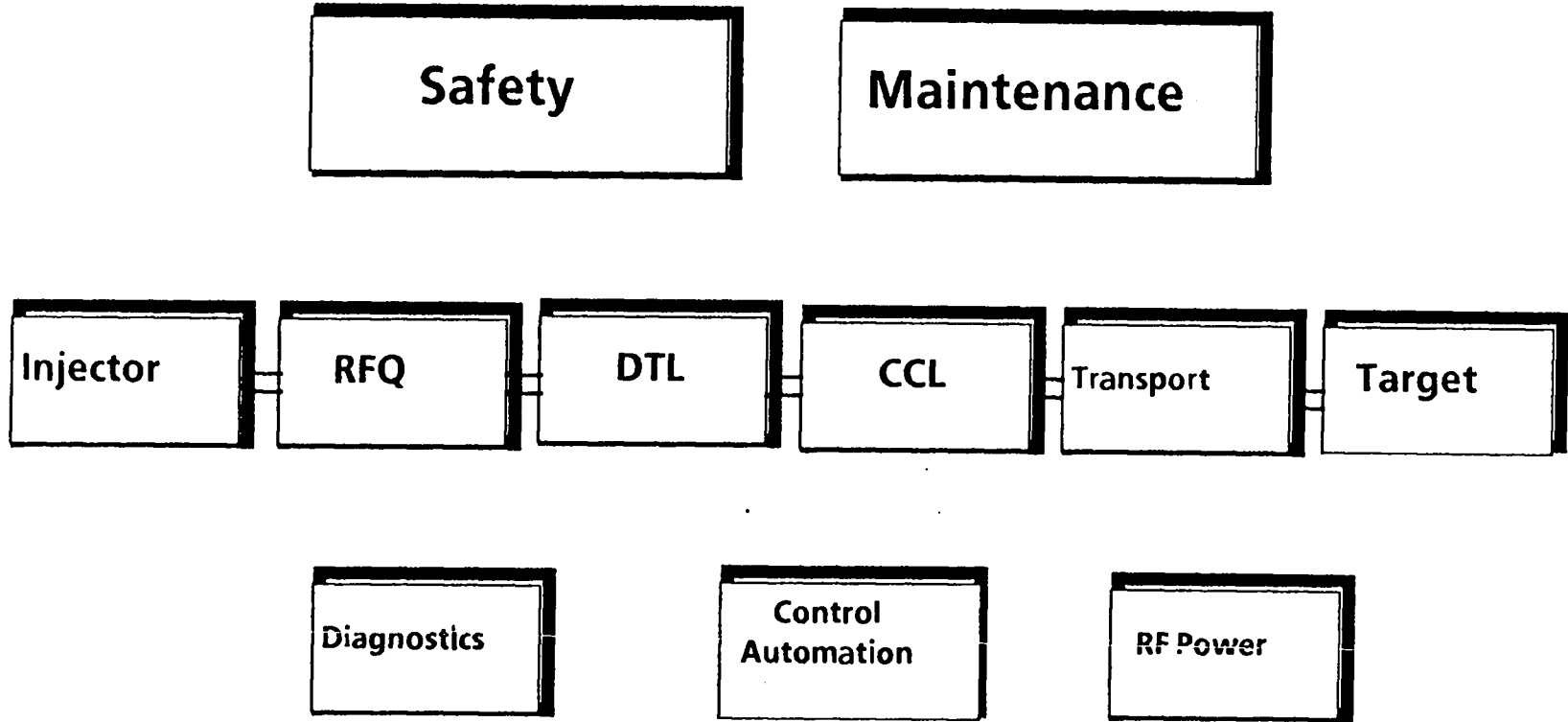

RFQ — Radio Frequency Quadrupole  
DTL — Drift Tube Linac  
CCL — Coupled Cavity Linac

## Materials Testing Accelerator

About forty years ago, a program was begun at the Livermore Research Laboratory for "electronuclear" breeding of material (Pu) using a linear accelerator (linac). A prototype drift tube linac (similar in purpose to the APT Stage II) was completed at Livermore in January 1952 for \$13M. The Mark I accelerator was 60 feet in diameter and 87 feet long with 9 MW of rf power at 12 MHz. A 20 foot opening was used for access to the vacuum chamber. Nine feet of concrete provided shielding for the target.

Rf operation was achieved in March 1952, followed by proton acceleration to 33.5 MeV in May 1952. Rearrangement of the drift tubes for 22.5 MeV output provided better operating conditions with intermittent proton acceleration of up to 225 mA and extended continuous proton acceleration at 50 mA. The ion source/injector could provide 500 mA for several hours before the electrodes and focusing grids would burn out. The accelerator was dismantled in December 1953.

Mark I was the prototype demonstrator for a \$427M, A-12 plant based on 500 mA of deuterons accelerated to 350 MeV with a 12 MHz accelerator requiring 400 MW of rf power. This project was canceled in August 1952 with the discovery of more uranium deposits in the USA. A later 1954 proposal for C-50, that was not funded, was to be half the cost for a 500 MeV, 320 mA deuteron beam from a 50 MHz linac.

Twenty years later a more modern linac, LAMPF, was built for medium energy physics research employing techniques and developments that occurred over those two decades. Many developments have taken place since LAMPF was built twenty years ago. These developments are being taken advantage of in the design of APT.

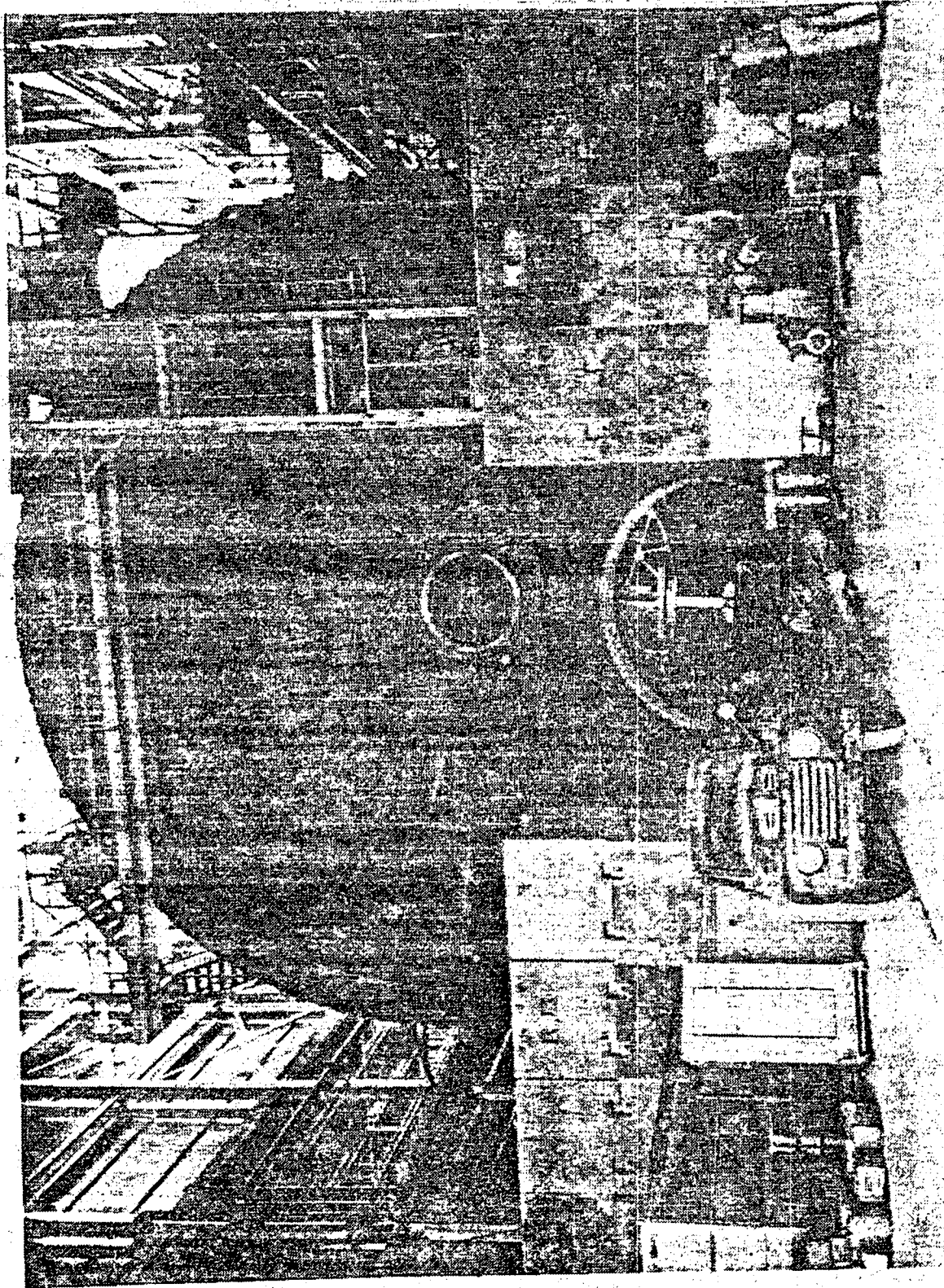

FIG. A-6 - VACUUM VESSEL HEAD, INJECTOR END

## LAMPF Provides a Relevant Basis for Extrapolation

Standard production conditions for LAMPF have an output 800 MeV proton beam with 15 mA peak current, 1 mA average current (560  $\mu$ s pulse, 120 pulses per second —6.7% duty cycle). LAMPF has the highest beam power of any accelerator worldwide in this energy range and has operated as a proton production factory (3000-4000 hours/year) for more than 10 years with demonstrated availability (fraction of scheduled beam time) greater than 85%. Program funding levels have restricted beam operation to about one half of the year.

LAMPF has components that are similar to those for APT —an injector for proton beam initiation, drift tube linac to 100 MeV, coupled cavity linac to 800 MeV, diagnostics, feed-forward rf amplitude control, ion pumps, quadrupole focusing, rf power systems, transport beam lines, safety, maintenance and a user community that wants reliable output beam with constant performance over long periods of time. The radiofrequency quadrupole had not been invented when LAMPF was built and is a component that would improve performance. Many APT components would be straightforward extensions of LAMPF hardware.

Beam losses and activation levels are very low for most parts of the linac. Total losses are carefully restricted during machine tuning by a fast loss-detector diagnostic system.

Unrestricted hands-on maintenance is possible over the entire length of the accelerator. Well developed remote-handling techniques are employed for maintenance and removal of highly-activated components in the experimental area (production targets).

## LAMPF Provides the Historical Technology Base

### Parameters

- 800 MeV proton energy
- Standard production conditions
  - Peak current: 15 mA
  - Pulse length, rate: 560  $\mu$ s, 120/s
  - Average current: 1 mA
  - Output emittance: 0.07  $\pi$  cm-mrad (n-rms)
- Coupled-cavity 805-MHz accelerating structure
- Only 1/4 of rf buckets contain protons
- 44 klystrons (1.25 MW peak power)
- H<sup>+</sup> and H<sup>-</sup> beams accelerated simultaneously
- 1.91 cm accelerating-structure aperture radius

### Operations

- Beam availability: > 85% of scheduled time
- Beam loss at 800 MeV: < 0.2 nA/m ( $2 \times 10^{-7}$ /m)



## LAMPF Accelerator

Transition between the DTL and CCL is shown for LAMPF. To the left is the 201.25 MHz DTL (74% larger in diameter than that of APT) and to the right is the 805 MHz CCL (15% smaller in diameter than that of APT). APT will have only a factor of two frequency increase between the DTL and CCL —LAMPF has a factor of four. The accelerating gradient (MeV/m) will be similar; a little lower for efficiency, and economic reasons.

Drift Tube  
Linac

Coupled Cavity  
Linac

LAMPF

2.21

38807086.2.21.509

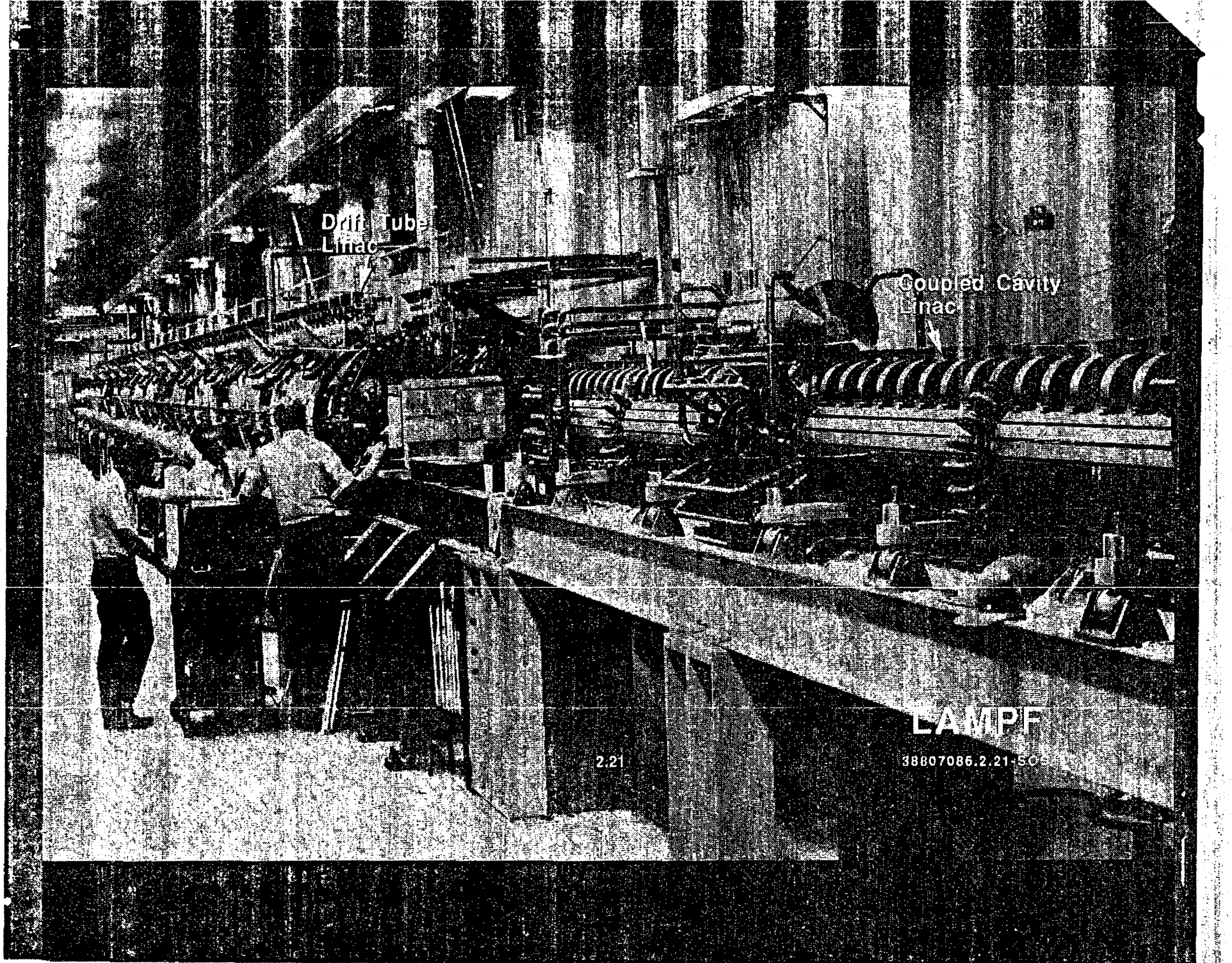

## LAMPF to APT

Twenty years of technology development has taken place since LAMPF was built (similar to the 20 years between MTA and LAMPF). Great strides in development, research, techniques and new tools have occurred in the past ten years—especially from emphasis placed in pushing accelerator technology very hard by the Strategic Defense Initiative (SDI) requirements for high performance, low-cost, high-efficiency accelerators (including support systems) that can operate in a space environment.

An RFQ provides a much improved beam for further acceleration by the APT linac. For reasons of efficiency, improved performance and modularity, the APT linac makes a change from DTL to CCL at 20 MeV—unlike 100 MeV for LAMPF. The injector operates at 100 keV, unlike 750 keV, which will lead to more reliable and improved performance for cw beams. The APT CCL is 2.8 times as long as LAMPF with 2.4 times the number of accelerating cells [the two numbers don't correspond directly because APT operates at a slightly lower accelerating gradient and longer cells have been added for the higher velocity particles (from 800 to 1600 MeV)].

A funnel is used to double the beam current and to have every rf bucket filled in the 700 MHz CCL. Funneling is the preferred method to obtain 250 mA with good beam quality—thereby minimizing beam loss and the resultant heating/activation in the accelerator.

Although the average current increases by a factor of 250 from LAMPF to APT, this is overshadowed by the more important point of only a factor of 4 increase in the amount of charge per beam bunch.

As part of the neutral particle beam (NPB) program for SDI, the Accelerator Test Stand (ATS) was used as a test bed to demonstrate advances in linear accelerator technology. Acceleration of protons up to 7 MeV was demonstrated with charge per bunch about 70% of that for APT and in a much more difficult regime—with smaller emittance. Code verification experiments and operation indicate that the front part of APT should work as designed. The Ground Test Accelerator (GTA) is the ground demonstration of an accelerator that could be used as part of the SDI architecture. It has to demonstrate operation under much more demanding conditions for a fully integrated accelerator with components similar to that of APT—smaller emittance, four beam funneling, cryogenic operation (40K), automated turn-on without operator assistance, higher accelerating gradient for RFQ, DTL and CCL, and complicated output beam transport.

# APT

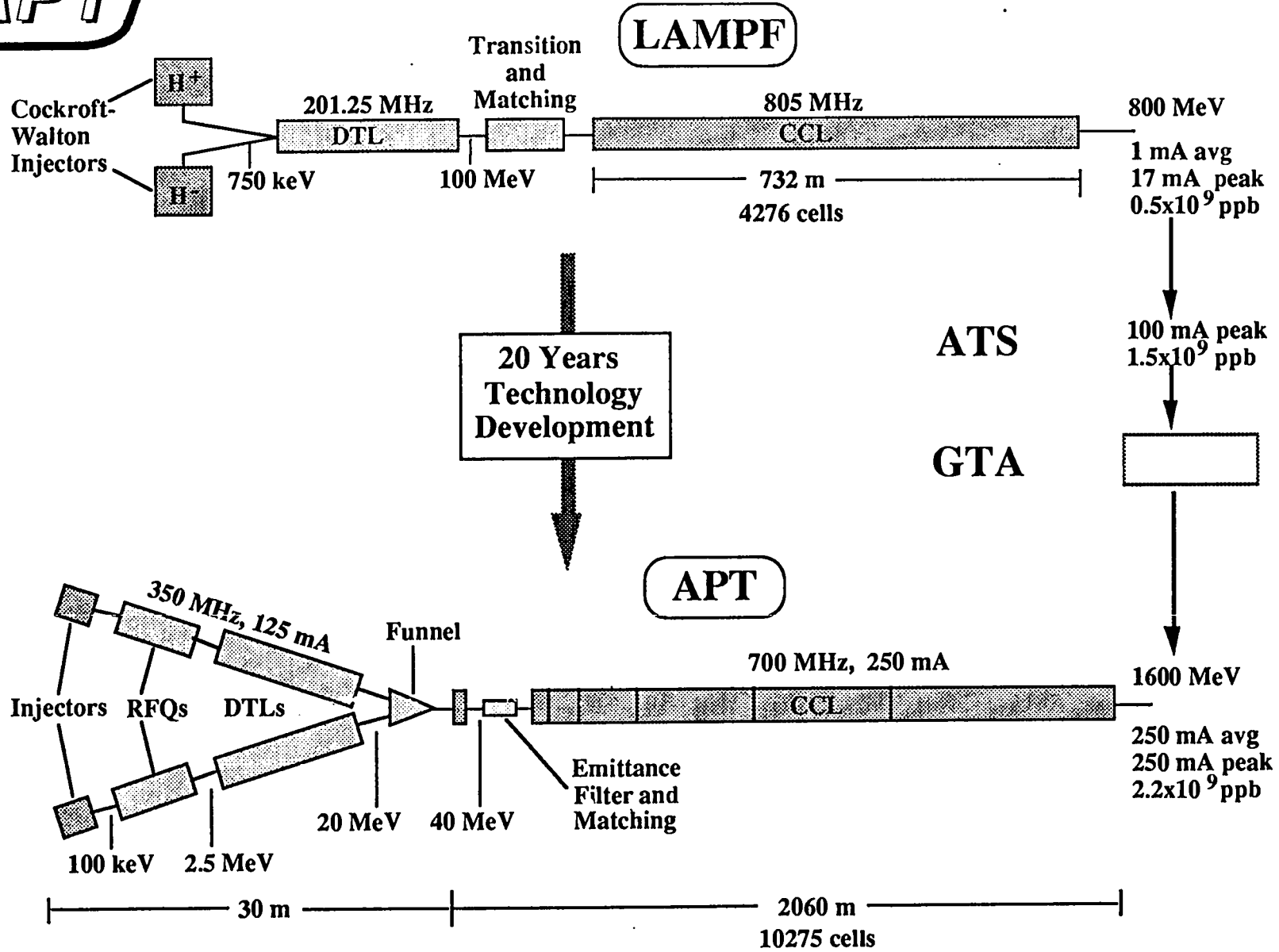

Los Alamos - Brookhaven

## Accelerator Test Stand (ATS)

A composite picture shows the actual ATS hardware and a layout diagram. Acceleration of pulsed 100 mA beams has been demonstrated with verification of design and simulation techniques. The ATS has been operated as an integrated system validating design procedures for injectors, RFQ and DTL combinations.

# NEUTRAL PARTICLE BEAM

## Accelerator Test Stand

BUNCHER CAVITY

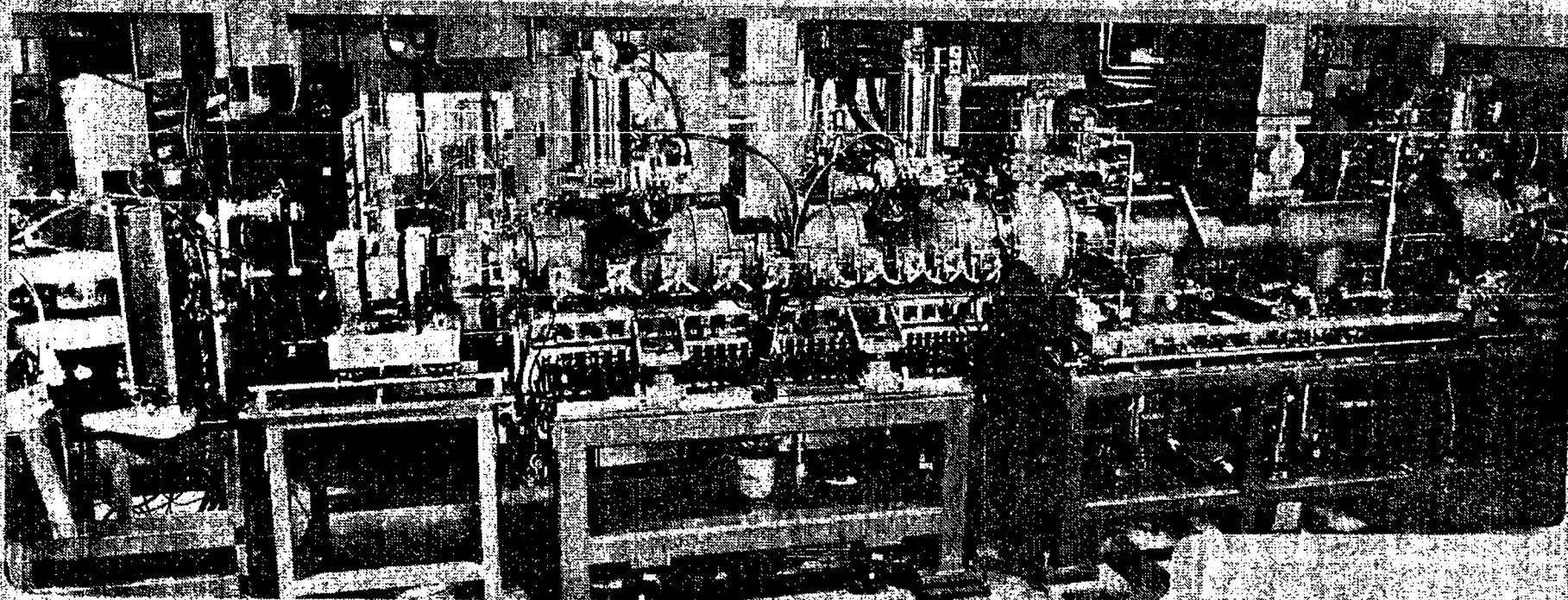
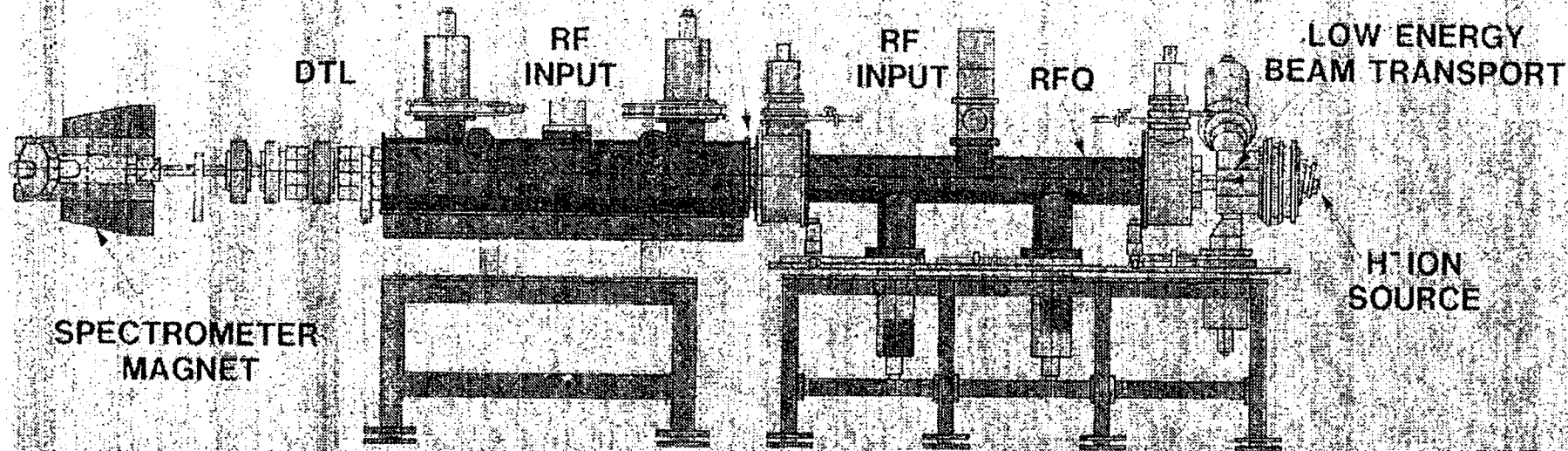

MC  
CU 86-3662

## Ground Test Accelerator (GTA)

Layout of the GTA is shown. Four injectors provide beam to four RFQ accelerators. The beams from the RFQs are funneled into two DTL accelerators. The beam is then funneled into a CCL accelerator. Output beam is transported around 180° and then expanded in a magnetic telescope. The  $H^-$  beam is neutralized and propagated over reasonable distances to determine characteristics and provide feedback to the control system.

Rf power at three frequencies is provided to the accelerator and controlled to very tight performance requirements for a heavily beam-loaded accelerator. The accelerator is operated at cryogenic temperatures (40K) and at relatively high accelerating gradients.

An important aspect of GTA is the involvement of an industrial partner (Grumman Aerospace) in the design, fabrication, commissioning and operation of the accelerator. Technology transfer has worked very well; so well, in fact, that Grumman is taking the lead on another development phase (CWDD) with LANL as backup. Because of capabilities within the industrial community and because of the state of accelerator technology, SDIO has begun the process to receive proposals for building a space qualified version of GTA.



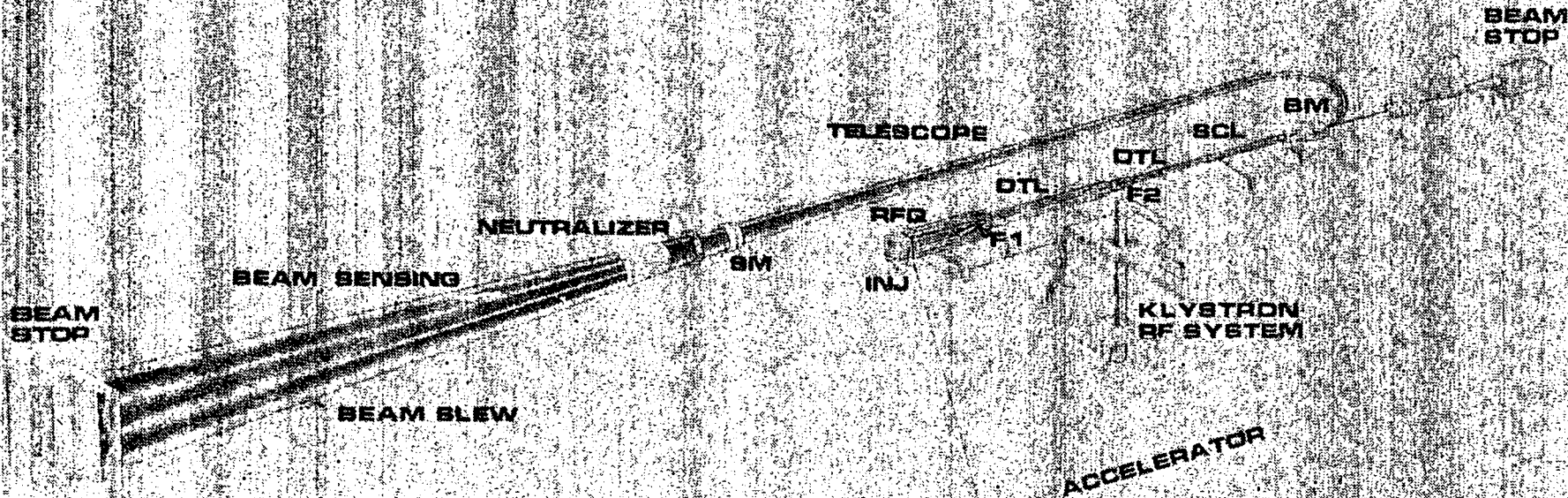

**GROUND TEST ACCELERATOR**

MAY 24, 1988



## Beam Experiment Aboard a Rocket (BEAR)

BEAR demonstrated how rugged accelerators can be built and their reliability. The BEAR accelerator consisted of an injector, RFQ, rf power, controls, diagnostics and a beam neutralizer. This accelerator has been flown on a rocket and completed its mission this summer.

The pulsed 1 MeV accelerator survived launch shocks (up to 50g) and landing in the desert (shocks up to 50g). The accelerator turned itself on, performed well and then prepared for landing —no operator interference was permitted.

Two important related facts on accelerator reliability and operability:

- 1.) The accelerator worked on the ground, after landing, without having to modify or replace components, and is still working.
- 2.) The first attempt to launch was a failure because the rocket engine failed to ignite. Because the payload was on a programmed sequence, the accelerator was turned-on and was checked to determine that everything was OK. The control system (thinking it was in space) then opened the vacuum valve for a violent rush of air into the accelerator. The accelerator payload was removed from the failed rocket and returned to the test bed. The accelerator was turned on and showed no filament damage to the ion source when pumped down again. The same ion source was flown on the successful mission.

BEAR was a successful program that involved a close industry / laboratory team.

**BEAR LIFT OFF AT WSMR**

**13 JULY 1989 0230 AM**

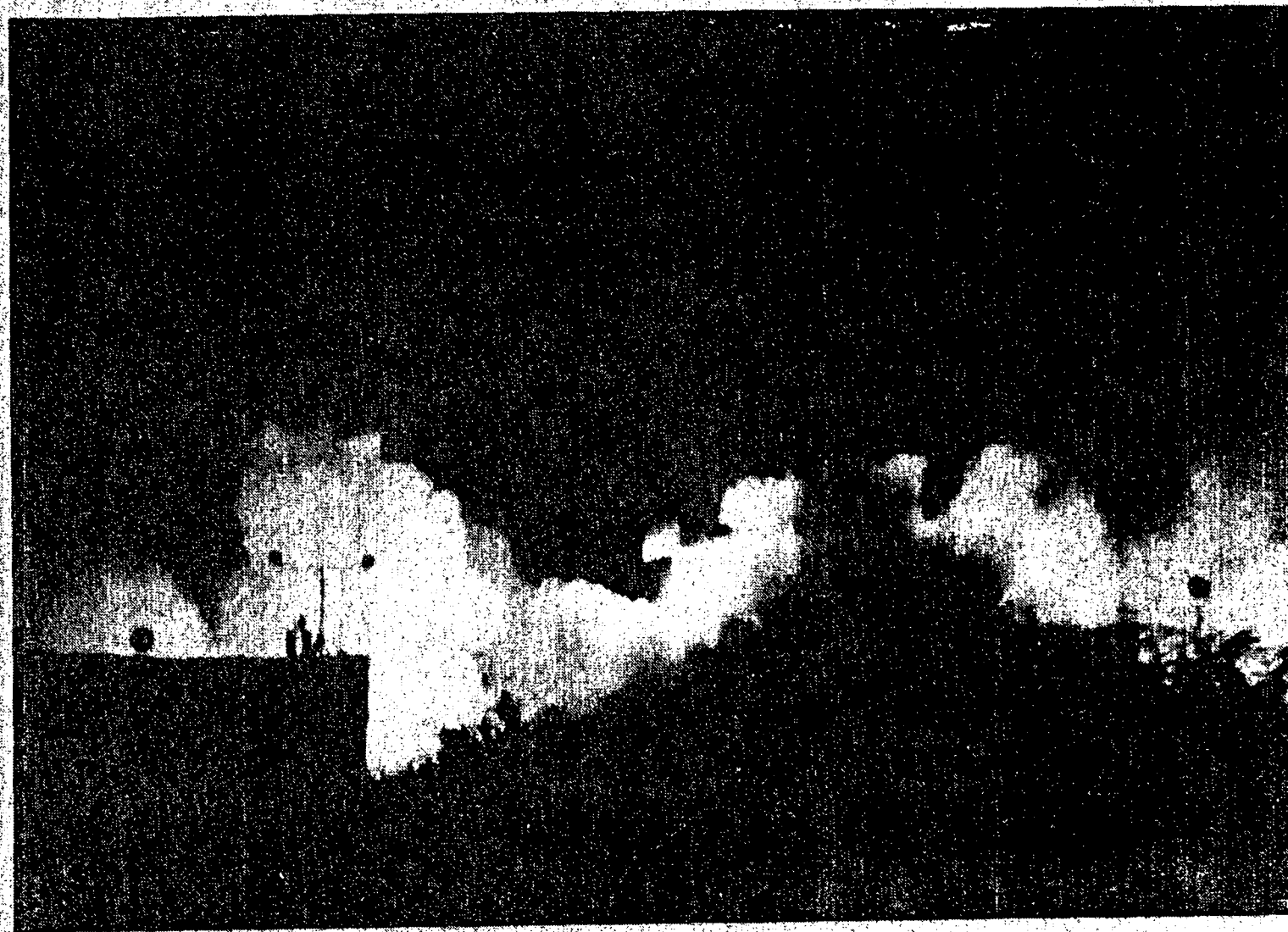

**Los Alamos**

## APT Site Plan

The overall length of the APT facility is estimated to be about 2500 meters. At the upstream end is the injector and at the downstream end the target area. The 482 klystrons are housed in 31 individual rf sector buildings. Servicing of the klystrons is accomplished in a centralized maintenance building with direct access to the accelerator tunnel at three locations. The control center is located at the downstream end of the machine in the vicinity of the beam transport and target area. The facility is serviced by a 345-kV, 1000-MVA switch station. The AC transformers and cooling towers are all located on the service and utilities side of the site. Ramps provide road access to the buried accelerator tunnel at several locations.

# APT

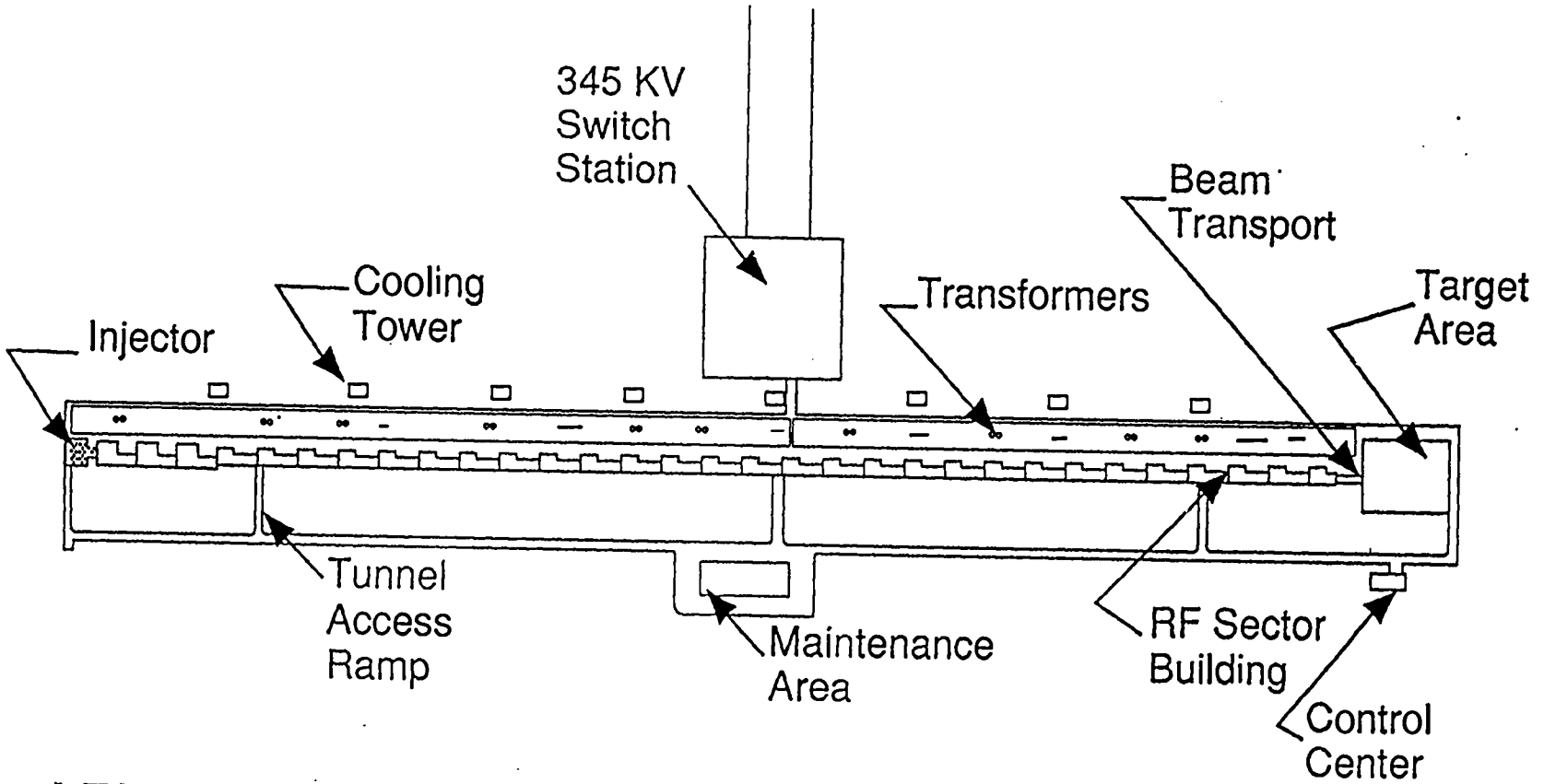

## APT SITE PLAN

0 1 2 3 4 500meters

*Los Alamos - Brookhaven*

## Machine Shielding and Power Layout

The accelerator is shown under an earth overlay for shielding purposes. The klystrons, circulators, amplifier controls, and DC power supplies are located in a sufficiently low radiation zone to permit continuous occupancy. A WR 1150 waveguide run through the earth overlay delivers rf power down to the accelerator tunnel. An adjacent service tunnel houses the relatively high-maintenance vacuum pumps, cooling interface equipment, and certain diagnostic instrumentation that must be close to the machine. Partial shielding of this service tunnel allows unlimited access (with beam off).

The machine tunnel is equipped with a radio/manually controlled bridge crane, shadow shielding for hands-on maintenance in locally "warm" areas, and sufficient space to allow remote servomanipulator equipment to work on "hot" areas of the machine if required. The modular nature of the machine design allows relatively straightforward removal of quadrupoles, diagnostic instruments, rf windows, and part or all of a given module. Connections are designed specifically for compatibility with remote maintenance equipment.

# APT

## APT ACCELERATOR TUNNEL AND RF GALLERY

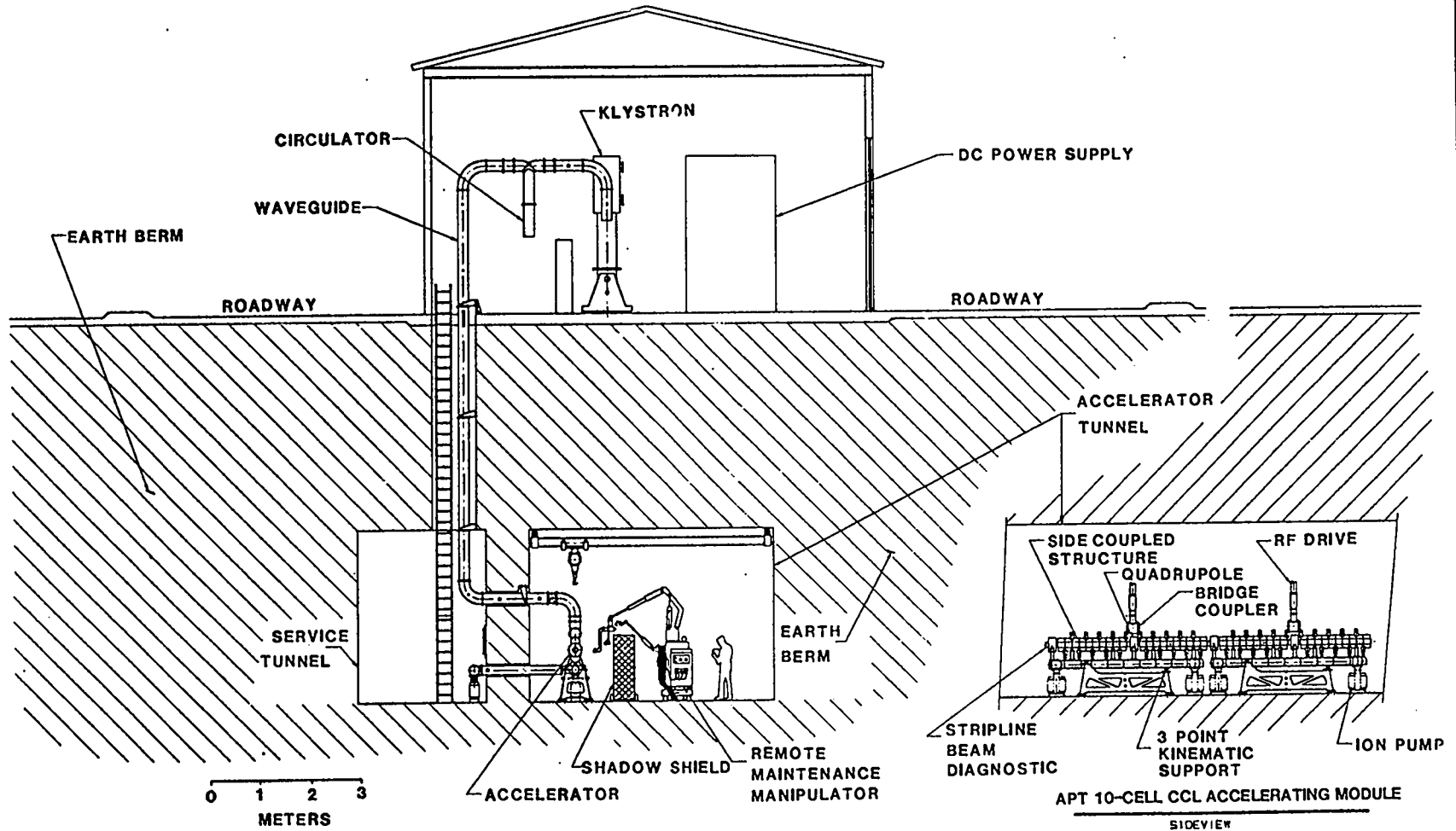

Los Alamos - Brookhaven

## Reference Accelerator Configuration

The APT linac is designed with minimizing beam loss as first priority and efficiency as second priority. The use of rad-hard electromagnetic quadrupoles imposes an upper limit to the frequency of the DTL. For performance reasons a two frequency linac design is employed —350 MHz for the RFQ and DTL, and 700 MHz for the CCL. The DTL is of  $2\beta\lambda$  type to accommodate focusing and acceleration requirements. To achieve best performance for 250 mA beam current, a beam funneling scheme is employed at 20 MeV —the transition between the 350 MHz DTL and the 700 MHz CCL. The CCL is designed in a modular fashion with the type of lattice units identified from 1 to 7. Type 1 is composed of 2-cell lattice units with the number increasing to 10 cells for Type 7. Overall there are 1451 lattice units with a total of 10275 accelerating cells.

An emittance filter is used at the 40 MeV location to remove beam halo if required and to assist with improving beam performance.

Lengths, rf power to the structure and beam power are shown for each type of accelerating structure. Also provided is an estimate of the number of rf tubes —470 at 700 MHz and 12 at 350 MHz. The adjoining table gives transverse and longitudinal emittances for the non-ideal beam case in which the beam is incorrectly matched to the DTL. Designing with a non-ideal beam provides a safety margin especially for considerations associated with beam loss.

# APT

## Reference Accelerator Configuration

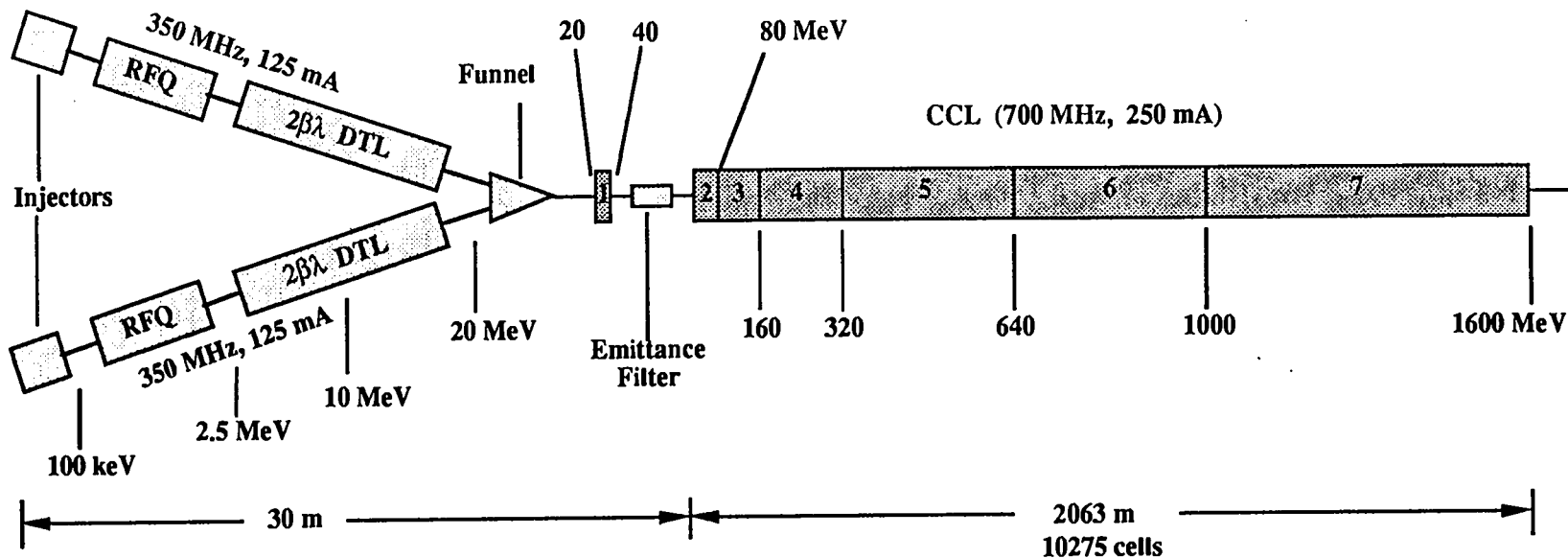

	Length (m)	RF Power (MW)			No. Tubes	Trans. Emittance* ( $\pi$ cm-mrad)		Long. Emittance* ( $10^{-6} \pi$ eV-sec)	
		Copper	Beam	Total		Input	Output	Input	Output
RFQ	3.4	0.4	0.3	0.7	2	0.020	0.023	0.0	1.4
DTL	11.3	1.3	2.2	3.5	10	0.024	0.061	1.5	2.9
CCL	2063	114.8	395.0	509.8	470	0.061	0.068	2.9	4.4
<b>Total</b>	<b>2100</b>	<b>118.2</b>	<b>400.0</b>	<b>518.2</b>	<b>482</b>				

**Total AC Power for Accelerator = 910 MW**

\* Emittance values are for non-ideal beam.

Los Alamos - Brookhaven



**APT**

## **APT Design Framework**

- Accelerator point design is based on established tools. Machine could be built today with moderate extensions from proven component performance.
- Enough design detail is provided to develop cost estimates and a system model for design tradeoff studies.
- Component development programs are identified that would pay off in lower construction and operating costs, and in reduced risk.
- Accelerator front end (to 40 MeV) should be built as an engineering demonstration:
  - To address system integration in a high power cw linac.
  - To address control methods and verify beam and operation predictions.

## Accelerator Design Philosophy

The beam energy (1600 MeV) and current (250 mA) were selected for a minimum tritium cost within beam dynamic constraints. The region selected has a fairly broad minimum in costs. Much lower energies have higher costs because of complications imposed on the accelerator design —injector numbers, lower rf frequency structures, larger apertures, multiple funnels, etc. Higher energies have higher costs because beam loading decreases (efficiency of rf conversion decreases) and length increases.

The design used LAMPF as a technology base because it is the best example of an integrated high-current proton factory. The charge per bunch extrapolation is less than a factor of 5. Average current extrapolation is a factor of 250; however the extrapolation to cw operation and filling each bucket (factor of 60) is more interpolation involving existing technology demonstrations and identical beam dynamics or beam performance as on LAMPF.

The CCL (the majority of the accelerator) was designed for 80% beam loading with the following priorities

1. ultra low beam loss
2. rf efficiency

The implications from these constraints are large apertures, low accelerating gradients and the need to employ radiation —hard components.

## Accelerator Design Philosophy

### Main Design Objectives:

1. High beam transmission and low losses  
Minimize resultant heating and activation of accelerator components
  2. Unit cost, efficiency, and reliability of rf tubes
- Establish good beam quality at the low energy end to minimize beam emittance and halo (RFQ, funneling, ramped DTL, high frequency)
  - At higher energies keep beam away from apertures and longitudinal bucket limits (large aperture, large bucket, good alignment, good phase control, low accelerating gradient)
  - Employ extensive diagnostics for beam control and maintenance of acceptable operating regime
  - Some halo and spill may still occur but activation effects can be limited (rad-hard quads (sets upper limit on DTL frequency), restrict transitions, emittance filters)

*Design front end to launch high quality, low-halo beam.  
Design CCL for ultra-low beam loss and high rf efficiency.*

## APT CCL Section 2

A typical modular section of the CCL is shown for the type-2 lattice. This type of lattice is used for accelerating protons between 40 and 80 MeV. The lattice has three accelerating cells per lattice element. The modularity has quadrupoles, diagnostics, and accelerating structure—which are repeated as a modular concept. Connections between the modules with bridge couplers minimizes the number of rf connections and eases control aspects because rf fields will be locked for larger portions of the accelerator.

The rf structure thermal response has been calculated and shown to be well within proposed operation bounds.

# APT

## APT CCL Section 2

Dimensions in cm  
Average  $\beta\lambda = 14.4$

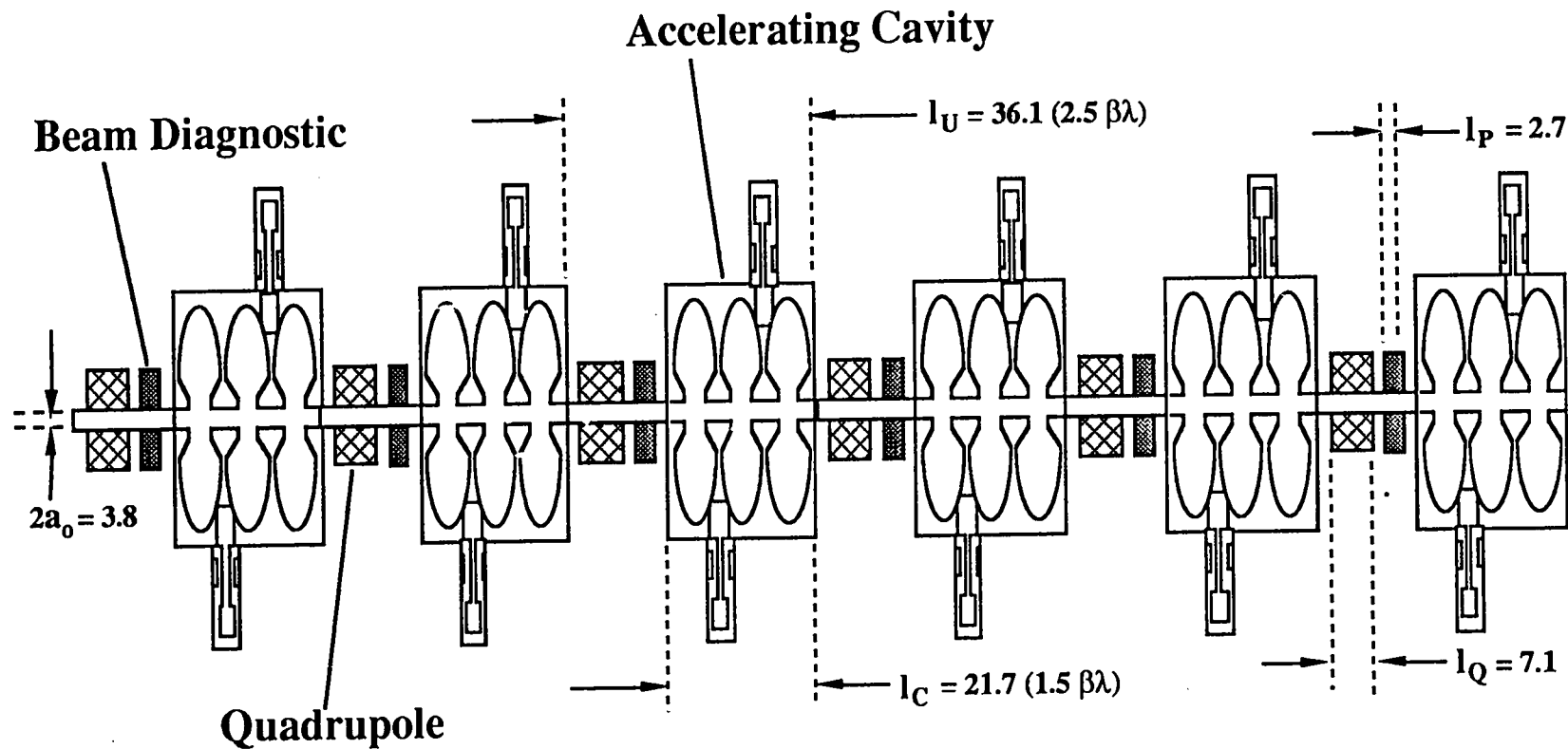

Los Alamos - Brookhaven

## Output Beam —Ideal

The upper two figures are emittance diagrams for the two transverse directions —X and Y. The lower right figure shows the longitudinal bucket and the location for the particles. The lower left figure shows the actual metallic wall location (the X-Y plane) and the location for the particles.

The actual space taken by the beam particles is much smaller than the available bucket stability area. Using such a small space leads to the improved performance for less beam loss.

# APT

## Output Beam Distribution From Linac Simulation Ideal Beam - 1600 MeV

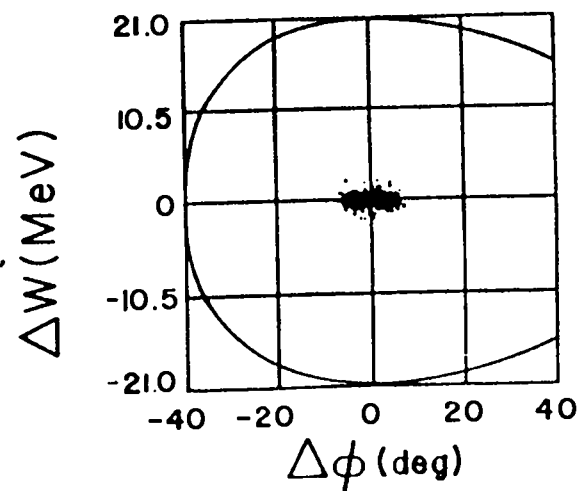
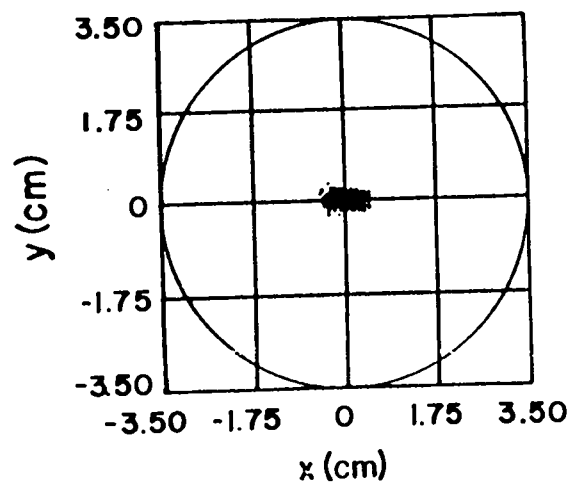
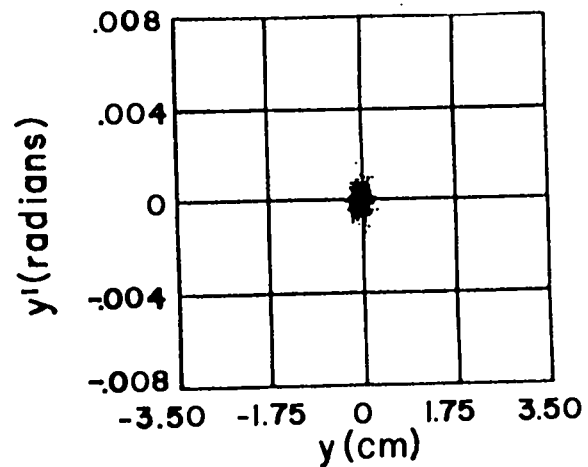
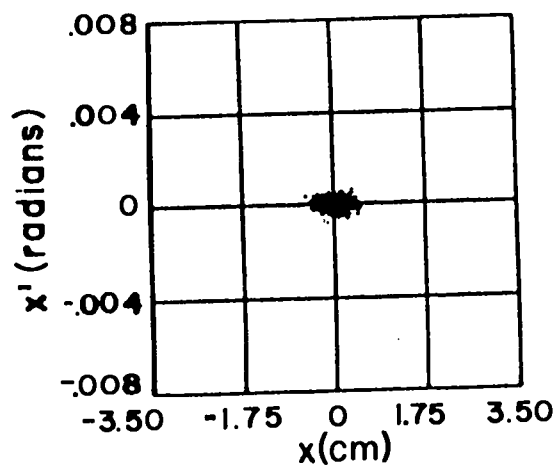

Los Alamos - Brookhaven

## Output Beam —Non-Ideai

The non-ideal beam shows that operation should be acceptable because the stability bucket is very much larger than that required for the particles being accelerated



# APT

## Output Beam Distribution From Linac Simulation Nonideal Beam - 1600 MeV

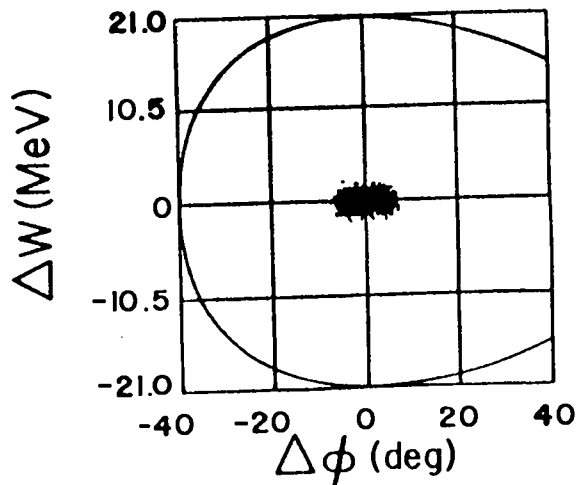
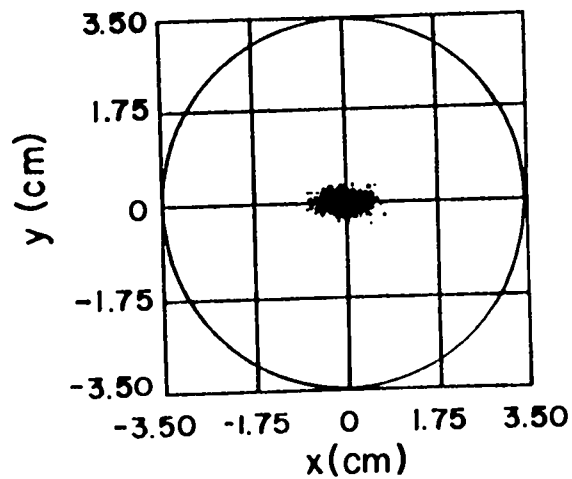
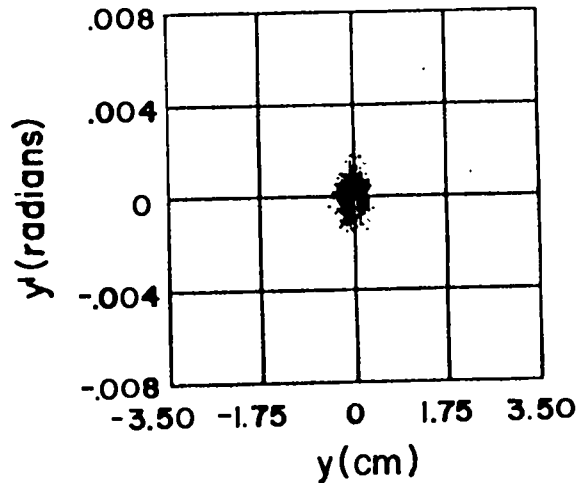
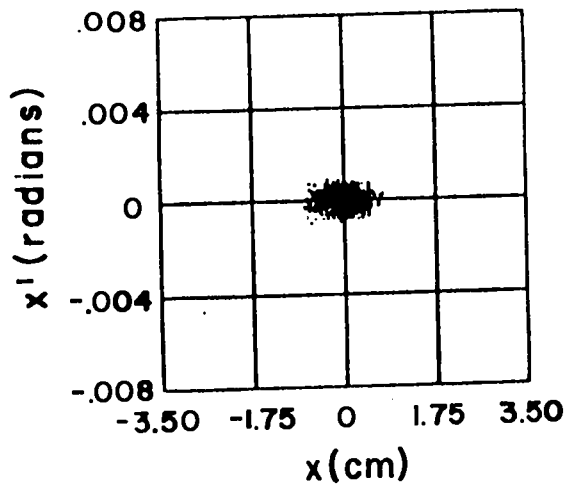

Los Alamos - Brookhaven

## RF System Efficiency

The klystron saturated efficiency is 70%. In order to allow some margin for control, the design output level is 95% of saturation. This reduces the effective klystron efficiency to 67%. Improvements in the RF generator efficiency are possible. Other devices and techniques which are still in the developmental stages have predicted dc-to-RF efficiencies higher than 80%.

The RF transport efficiency is 96% implying a total loss of 0.2 dB. Most of this loss would occur in the circulator. The losses might be reduced with the use of a "magic tee" as the RF isolation device. Other considerations in the isolation device such as system complexity and flexibility lead us to the circulator as our baseline device.

Losses in the power conditioning portion of the RF system occur primarily in the high voltage power supply and in the fanout and isolation section. The use of reactive isolation instead of resistive can minimize the losses and an overall efficiency of 95% for this portion of the system is feasible.

The final efficiency term comes from the beam loading factor. Higher beam loading leads to less wasted power in the accelerator. 80% beam loading is already very high, but there remains the possibility of increasing this factor after further study.

## RF System Overview

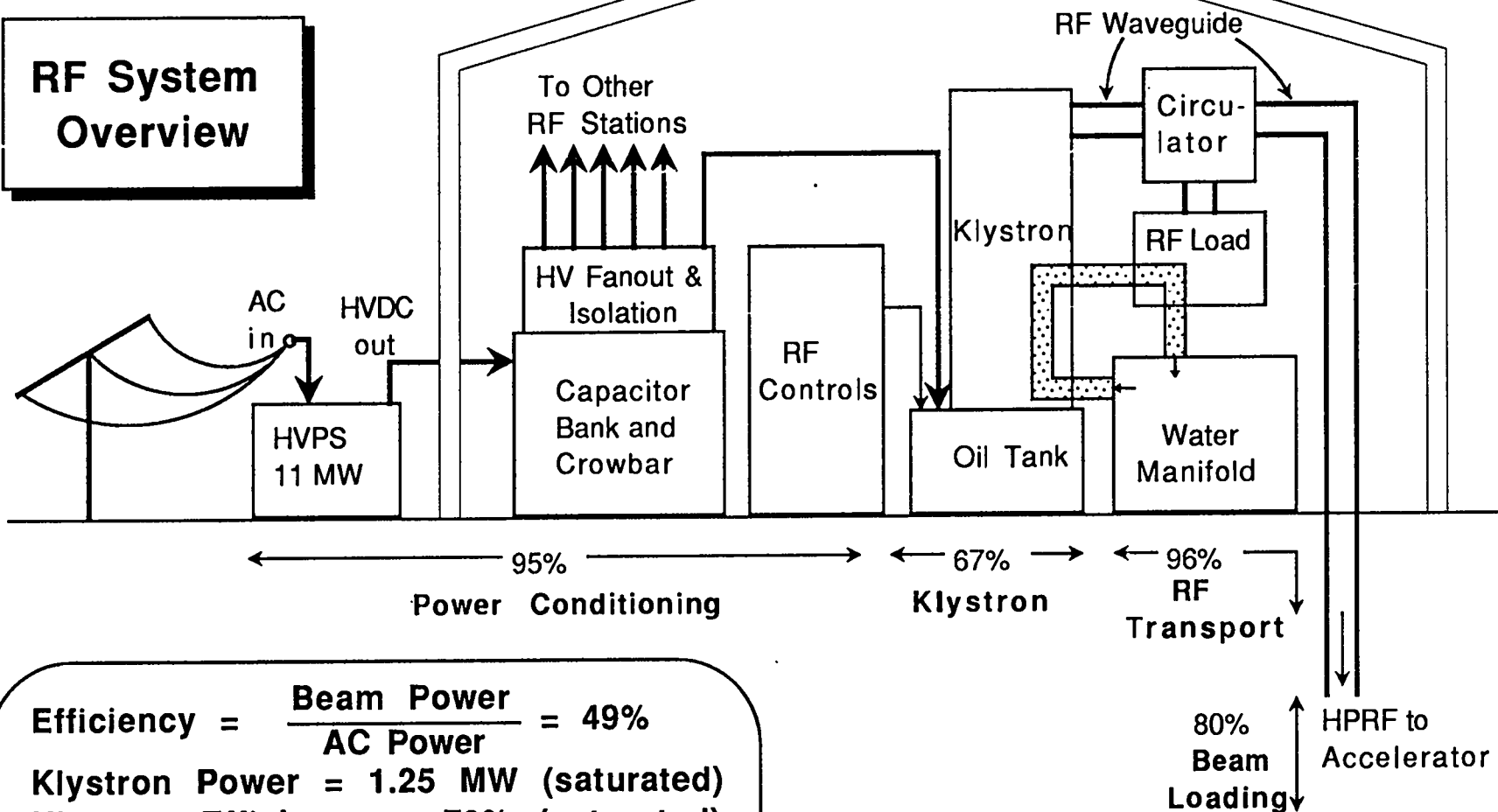

$$\text{Efficiency} = \frac{\text{Beam Power}}{\text{AC Power}} = 49\%$$
 Klystron Power = 1.25 MW (saturated)  
 Klystron Efficiency = 70% (saturated)  
 700 MHz → 470 klystrons  
 350 MHz → 12 klystrons  
 Water Requirements = 225,000 gpm

## Nonlinear Beam Expander

The nonlinear beam expander utilizes nonlinear magnetic elements, more specifically octupoles and duodecapoles, to produce a rectangular uniform beam intensity distribution at the APT target. Such a distribution optimizes tritium-production efficiency and target cooling. An octupole affects a properly focused beam in the following way: it has essentially no effect on those particles close to the optical axis, it has the desired effect on the particles in the significantly populated beam fringes and it has an undesirably large effect on the particles in the halo of the beam. Overall, the shaping of phase space is such that the beam fringes are subsequently folded into the core of the beam, thereby transforming a peaked intensity distribution into a uniform intensity distribution. The undesirably large effect on the beam halo can be counteracted by adding a duodecapole component to the octupole.

A nonlinear beam expander thus has the following components: Octupoles to fold the beam fringes into the core of the beam (one octupole to shape the horizontal phase space, one octupole to shape the vertical phase space), quadrupoles to prepare the beam for the octupoles and to control the beam size at the target, and duodecapoles to control the beam halo.

A viable nonlinear beam expander design to produce a 4m by 2m beam at the APT target is described in Tables I and II. The pole tip fields are kept at or below 1.5 T, within practical design range.

**Table I**

List of beamline elements to produce a 4m by 2m rectangular beam. The lengths of the drifts and the effective lengths, radii, and pole tip fields of the magnetic elements are given.

Type of Element	Length [m]	$r_0$ [m]	$B_p$ [T]
first octupole	0.50	0.020	0.768
drift	6.50		
focusing quadrupole	0.50	0.100	0.715
drift	2.19		
second octupole	1.00	0.134	0.914
drift	15.50		
defocusing quadrupole	2.00	0.356	1.500
drift	10.50		

**Table II**

Description of the duodecapole components added to the octupoles

Type of Element	Length [m]	$r_0$ [m]	$B_p$ [T]
first duodecapole	0.50	0.020	0.538
second duodecapole	1.00	0.134	0.678

# APT

## Nonlinear Beam Expander

Octupoles transform a peaked beam distribution into a rectangular uniform distribution.

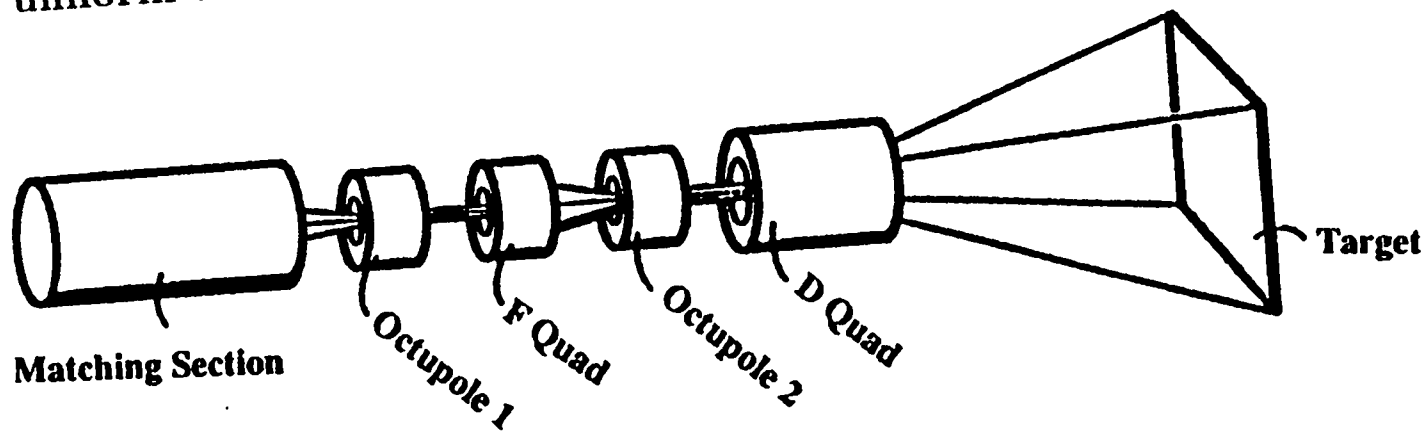

- Magnets can be constructed; have pole tip fields of  $\leq 1.5$  T.
- Magnet power requirements are tractable; power is  $\leq 2$  MW for all components.
- Beam expander can transport  $7\sigma$  of the beam.

Los Alamos - Brookhaven

## Beam at APT Target

The performance of the nonlinear beam expander of Table I (previous viewgraph) was checked with the particle tracking code PATH. Initially Gaussian, as well as initially parabolic, beams were sent through this transport line. The beam had the desired 4m by 2m area, with beam outside this area decreased five orders of magnitude for pure octupole magnets and virtually eliminated in the case of combined function octupole/duodecapole magnets. Beam elimination is true regardless of the initial beam profiles. The intensity distribution within the 4m by 2m area, on the other hand, certainly depends on the initial profile. It can be made essentially constant for initially parabolic beams but inevitably has significant structure for initially Gaussian beams. In particular, substantial cusps appear at the distribution edges when greatest uniformity is obtained in the center. Further work in this area should demonstrate improvements in performance and the required criteria, including diagnostics and control methods, to ensure acceptable distributions for small amounts of mis-steering or energy fluctuations.

# APT

## Beam at APT Target

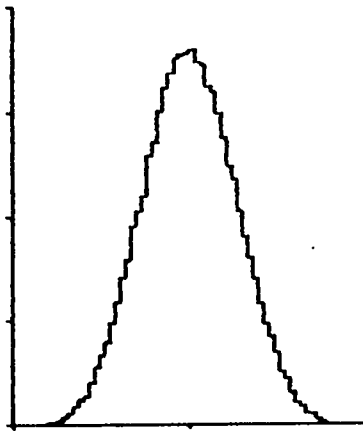

Gaussian Beam Profiles  
Upstream of Beam Expander

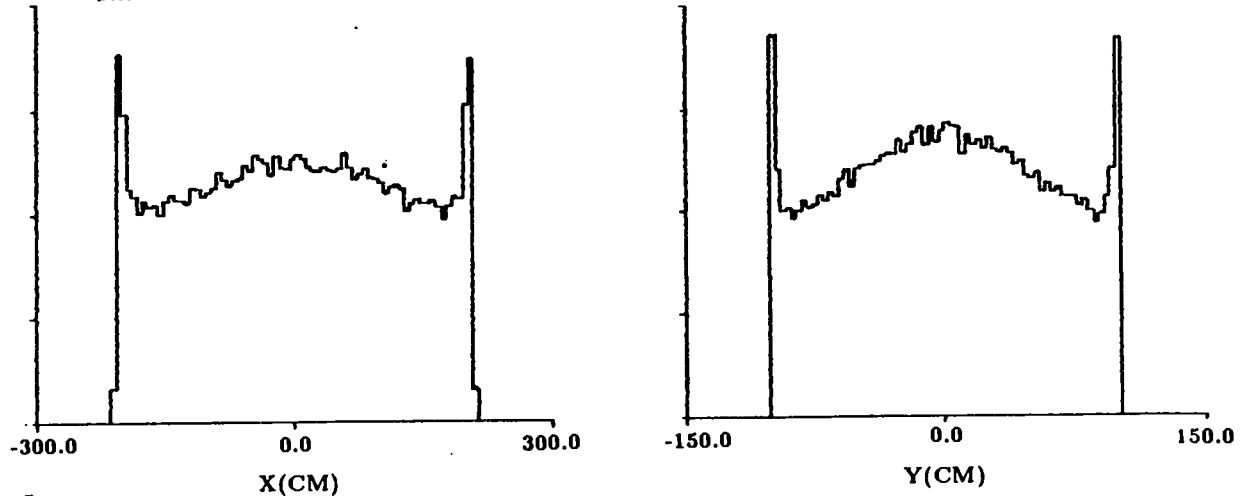

Beam Profiles at APT Target

- Beam at target has desired 4m by 2m area.
  - Sharp drop to very small intensities outside the 4m by 2m area when duodecapoles are off.
  - Halo to  $7\sigma$  contained in the 4m by 2m area when duodecapoles are on.
  - Above statements true regardless of initial beam profiles.
  - Intensity distribution within the 4m by 2m area very uniform for initially parabolic beams.
- but:
- Intensity distribution within the 4m by 2m area depends on initial beam profiles.
  - Intensity distribution within the 4m by 2m area depends on steering.

**Key Issues —Accelerator**

More information is found in the accompanying documentation.



## Key Issues — Accelerator

There are many issues when considering operation of a production factory

- **Code validity** — basis of accelerator design
- **Beam losses** — heating and activation
- **Maintenance, failures** — scheduled program and estimates
- **Reliability, safety** — operating regimes, restrictions, and procedures
- **Remote operation** — experience and equipment
- **Accelerator factories** — experience at operational facilities
- **Factory operation** — procedures for turn-on, turn-off, and monitoring
- **Power** — load characteristics
- **"Burps"** — characteristics of microdischarges
- **Instabilities** — design conservative

## Issue-Code Verification

Characteristics of two production linacs (LAMPF and CERN), the LANL test stand for NPB beams (ATS) and APT are shown. Particles per bunch are larger in the CERN machine than for APT. Fairly good agreement is seen for the operating systems. The reason for using non-ideal beams in APT calculations is evident in placing upper bounds for performance—to assist in bounding the beam-loss threat.

“Ideal” refers to an assumed distribution from the injector, “realistic” uses the measured injector distribution and “non-ideal” refers to a mismatch at the RFQ entrance.

## Transverse Emittance Growth in High-Current Linacs Comparison of Measurements with Simulation

	LAMPF DTL + CCL	CERN DTL	CERN DTL	ATS-1 <sup>a</sup> RFQ+DTL	ATS-2 <sup>b</sup> RFQ+DTL	APT RFQ+DTL+CCL
Output Energy (MeV)	800	10	50	5	6.7	1600
Peak Current (mA)	17	82	150	75	75	250
Particles per Bunch	$0.53 \times 10^9$	$3.3 \times 10^9$	$4.6 \times 10^9$	$1.1 \times 10^9$	$1.1 \times 10^9$	$2.2 \times 10^9$
Transverse Emittance:						
Growth (Simulation)	8.7 (ideal)	1.2 (ideal)	1.1 (ideal)	2.5 (realistic)	1.6 (realistic)	1.5 (ideal) 3.4 (non-ideal)
Growth (Measured)	7.9	1.9	2.9	$3.5 \pm 0.35$	$1.8 \pm 0.18$	---
Output (Measured)	0.070	0.070	0.14	$0.060 \pm 0.006$	$0.030 \pm 0.003$	---

a. Uniform-field DTL ( $E_0 = 2$  MV/m). Results quoted are from 1989 measurements. Majority of emittance growth is caused by quadrupole-orientation errors in drift tubes.

b. Ramped-field DTL ( $E_0 = 2$  to 4 MV/m).

## Beam Loss is a Major Issue for APT

**Beam losses produce heating, as well as neutron- (and other) radiation that can:**

- Damage the accelerating structures.
- Degrade accelerator component performance.
- Produce activation levels that complicate machine maintenance.

**A radiation-environment model of the accelerator is being developed to:**

- Estimate beam-loss allowances as a function of proton energy.
- Calculate shielding requirements as a function of proton energy.
- Assess the lifetime threat to accelerator components.

**Beam halo is undesirable because it can lead to beam loss.**

- Transitions in the accelerator where parameters change (bunching, funneling, RF structure frequency, quadrupole periodicity) increase the halo and cause local losses.
- Transitions should be kept at low energy to minimize activation associated with beam losses.

## Procedure for Estimating Beam Loss per Unit Length in LAMPF CCL

- Start with table of activation readings taken (1 foot from beamline) at CCL quads, 1 to 2 hours after shutdown, following 2 to 3 months operation at 1 mA.
  - Divide activation data at each quad by Cu/Fe neutron yield at that energy. Produces quantity proportional to beam loss per linac tank.
  - Current transmission monitors show typical beam loss from 200 to 800 MeV is 400 nA. With some accelerator tunes beam loss is < 100 nA, which is the monitor sensitivity.
  - Sum converted data from 200 to 800 MeV. Normalize to 400 nA. Produces approximate beam loss per tank.
  - Correct for differing tank lengths to give estimated beam loss per unit length.
- 
- PSR extraction septum activation and beam loss estimate provides 800-MeV calibration; 1 nA loss produces 20 mRem/h activation at 1 foot. Agrees with derived CCL 800-MeV correlation within factor of 2.

**APT**

### Estimated Beam Loss in LAMPF CCL for 1 mA (Avg) Operation

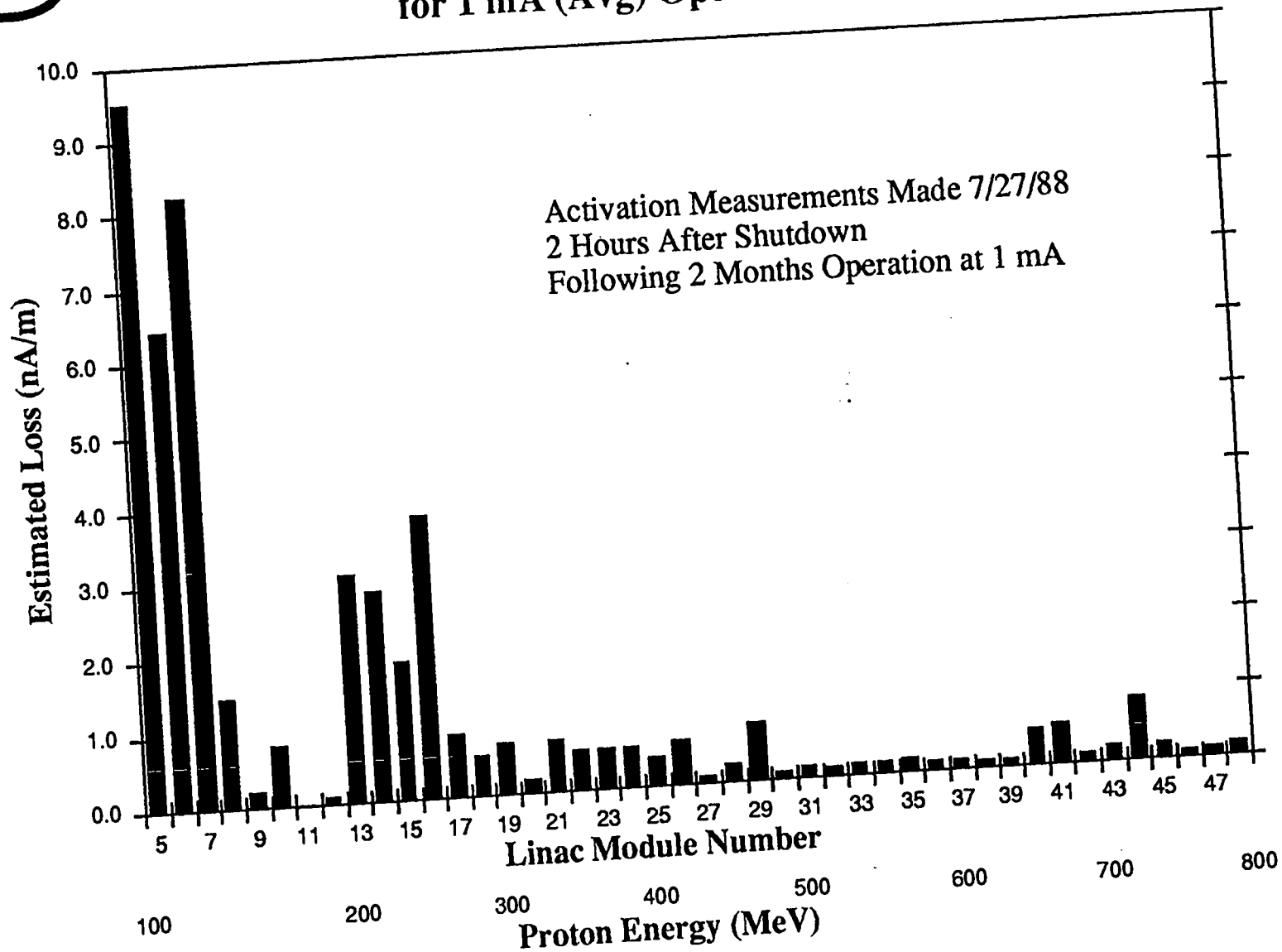

Los Alamos - Brookhaven

## Pulsed LAMPF — Macropulse Beam Loss

Any pulsed linac will have the characteristics shown below as a function of the rf pulse length. Integrated dose is about three times higher for the turn-on phase as compared to the stable operating region. A cw accelerator should have an improvement by about a factor of three over a pulsed machine, when extrapolating pulsed machine performance to cw.

# APT

## LAMPF beam-loss monitor readout, showing time dependence of loss for pulsed beam.

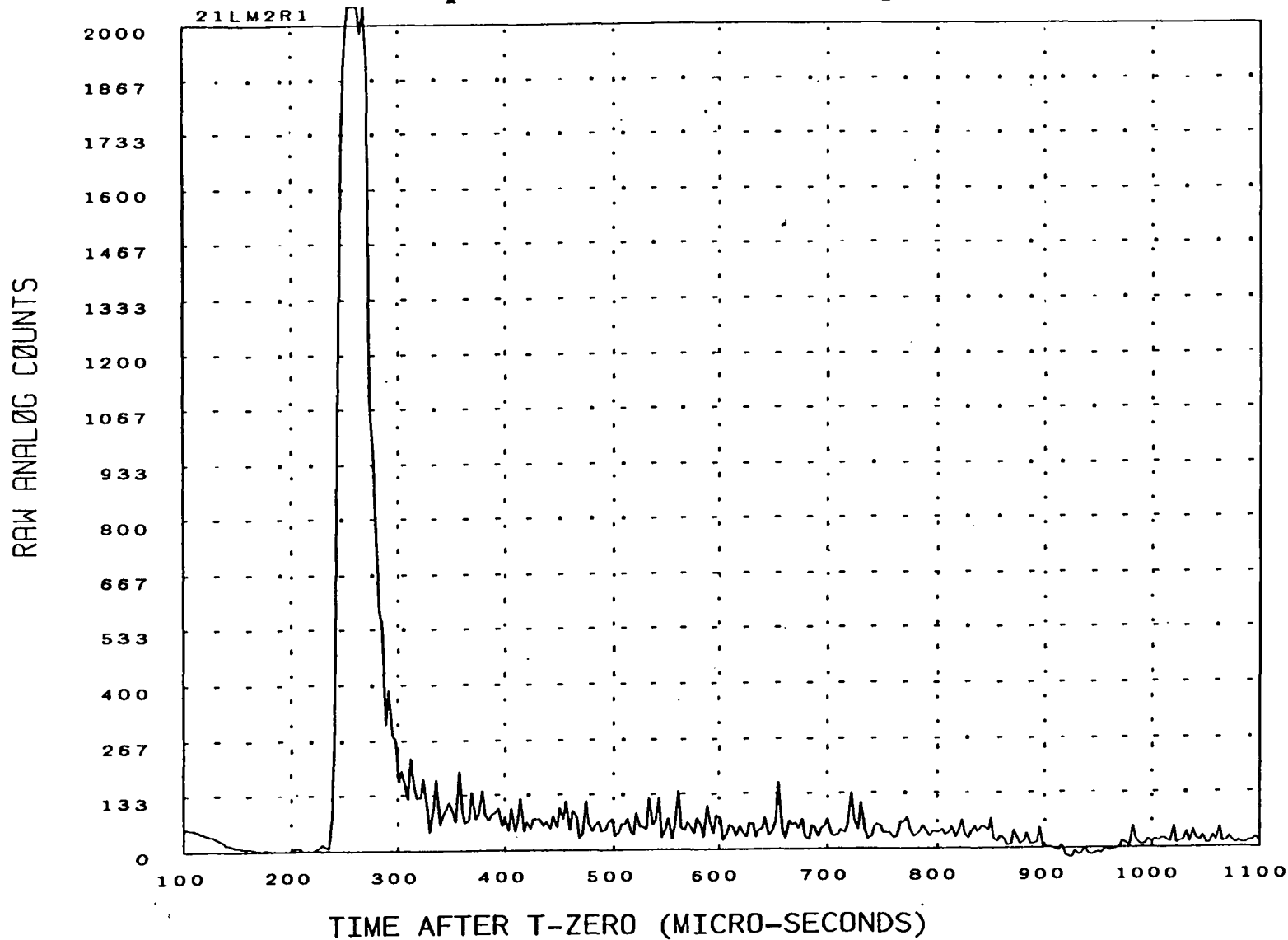

Los Alamos - Brookhaven



---

## LAMPF Scaling

Extending LAMPF to cw operation (cannot be done in practice) with every bucket full shows that a linac operating with beam bunch characteristics identical to LAMPF could produce 25% of APT design goals with hands-on maintenance—even without taking advantage of the factor of three improvement to be realized from the turn-on radiation transient that will not be present for cw. Improvements in accelerator technology over the past 20 years should lead to better performance.

## Activation Estimate by Scaling from LAMPF Operating Conditions

- Extend LAMPF to 1) cw operation and 2) fill all 805-MHz rf buckets.
  - No increase in protons/bunch (identical beam dynamics).
  - Linac current and activation would increase by factor 60.
    - x 15 from duty-factor increase
    - x 4 from filling rf buckets
  - Average current would be almost 25% of APT design goal.
  - Activation levels would be 50 to 200 mRem/h.
  - **Hands-on maintenance**, although with limited access time.
- \* Linac design improvements permit x 4 increase in particles-per-bunch without increased beam loss.

### Hands-on vs Remote Maintenance

<b>10 mRem/h and below</b>	Unconstrained hands-on maintenance.
<b>100 mRem/h</b>	Hands-on maintenance; limited access time.
<b>1 Rem/h</b>	Hands on maintenance with carefully controlled, very-limited access.
<b>10 Rem/h and above</b>	Remote maintenance required.

# Ultra-Low Beam-Loss Features in APT Design

- Very large ratio of aperture to RMS beam size; increases with  $E_p$ .
- Large ratio of RF-bucket width to RMS bunch length, increases with  $E_p$ .
- Minimize abrupt acceptance transitions.
- Emittance filtering at 40 MeV, after final disruptive beam manipulation.
- Accurate centering of beam in aperture; high density of position monitors and steering elements.
- Accurate maintenance of bunch center on synchronous RF phase; good longitudinal diagnostics and RF phase control.

**Beam Losses and Activation Levels for  
LAMPF and APT at 800 MeV**

	<u>LAMPF</u>	<u>APT</u>
Activation (mRem/h)	4*	100
Beam loss (nA/m)	0.2	5
Fractional loss /m	$2 \times 10^{-7}$	$2 \times 10^{-8}$
Aperture/beam RMS	6.3	20

\* Except for a few hot spots

**APT needs 10 times lower fractional loss /m than LAMPF to retain hands-on maintenance. A factor of 100 should be achievable.**

- \* APT has factor of 2 to 3 advantage because it is not a pulsed machine.
- \* Need additional factor of 5 to 3 from large aperture/beam-RMS ratios. We believe that much larger factors will be attainable.

## Staged Development

A staged development program will reduce program risk. Areas that will be covered by the four year development program (Stages I and II) are shown. Further risk reduction will occur in Stage III as shown in the chart.

## STAGED DEVELOPMENT OF ACCELERATOR REDUCES PROGRAM RISKS

### Stage I (Injector plus RFQ) LLNL equipment available

- Ion source lifetime, low noise operation, beam dump verification
- RFQ cw operation at 125 mA/2.5 MeV, rf interfaces
- Beam transmission, emittance
- Integrated control, turn-on, fault handling, reliability, transients, burps
- No-beam to full-intensity, charge neutralization
- Diagnostics testing
- Heating, no activation

### Stage II (Stage 1, DTL, Funnel, 20 MeV of CCL, Emittance Filter)

- Verify performance of DTL, funnel, and CCL
- Benchmark halo growth predictions, beam-loss estimates
- Assess contact-maintenance feasibility for 160-MeV prototype
- Confirm turn-on and accelerator protection schemes
- Establish national base for 700 MHz rf

### Stage III (Funneled Front-End Prototype, to 160 MeV)

- Verify beam properties, adequacy of diagnostics
- Control and turn-on of highly beam-loaded CCL
- Demonstrate beam-loss control, fast beam shutdown
- Demonstrate system operability and high availability
- Determine optimum technical path to tritium production accelerator
- Test tritium production with beam on prototype target/lattice
- Evaluate remote handling requirements for production accelerator

## **cw Proton Injector**

Proton injectors have operated cw near the APT requirements at two laboratories listed on the chart. A duoPIGatron plasma generator was selected because of stability at high current density, low ion temperature, low magnetic field and the fact that it is a mature technology that is being used in cw commercial applications. It has not been determined whether single or triple aperture extraction will be used.

Two-stage extraction was selected to enhance resistance to sparking, to permit mass analysis and shaping of the beam between the 35 and 65 kV stages, and to have a low extraction voltage which should lead to a high brightness beam.

Injector components consist of an  $H^+$  ion source, solenoid lens,  $60^\circ$  bend magnet for ion species selection, solenoid lens, and the 65 kV accelerating column.

## CW Proton Injector Technology — — — The-State-of-the-Art

- Operation of RTNS-II (LLNL), the driver for the high-flux 14 MeV neutron source — used as a basis for putting upper bounds on maintenance and operation.
- 360 keV (35 keV extractor), 80 mA D<sup>+</sup> injector — 80 hours/week for several years

	APT	Chalk River (CRNL)		Karlsruhe (KFA)
Project	Tritium	Accelerator Breeder		Spallation Neutron Source (SNQ)
Aperture	TBD (1 or 3)	One aperture	Seven apertures	one aperture
Injector (keV)	100	46	46	50
Extraction (keV)	35	46	46	50
Current (mA)	150	50	320	100
Emittance ( $\pi$ cm – mrad)	0.02	0.0057	0.046*	0.024
Brightness [ $A/(cm\text{-mrad})^2$ ]	75	344	31*	35

\*without beamlet steering



## 750 kV Cockcroft-Walton at LAMPF and RFQ

Shown for comparison are a 750 kV Cockcroft-Walton (C-W) generator and a 1000 keV RFQ with ion source. Power supplies and supporting equipment are not shown. CRNL demonstrated that cw currents (total extracted) in excess of 30 mA from a single 750 kV C-W were not reliable. At 50 kV they achieved cw currents (total extracted) in excess of 850 mA. Injection energies to a DTL below 750 keV make it very difficult to design a suitable DTL without extensive modifications, such as alternating phase focusing or drift tube extension focusing.

The RFQ has many other attributes including 90% transmission, adiabatic capture for transformation of DC to rf beams, elimination of bunching cavities with associated transport lines and beam losses, and small change in transverse beam properties.

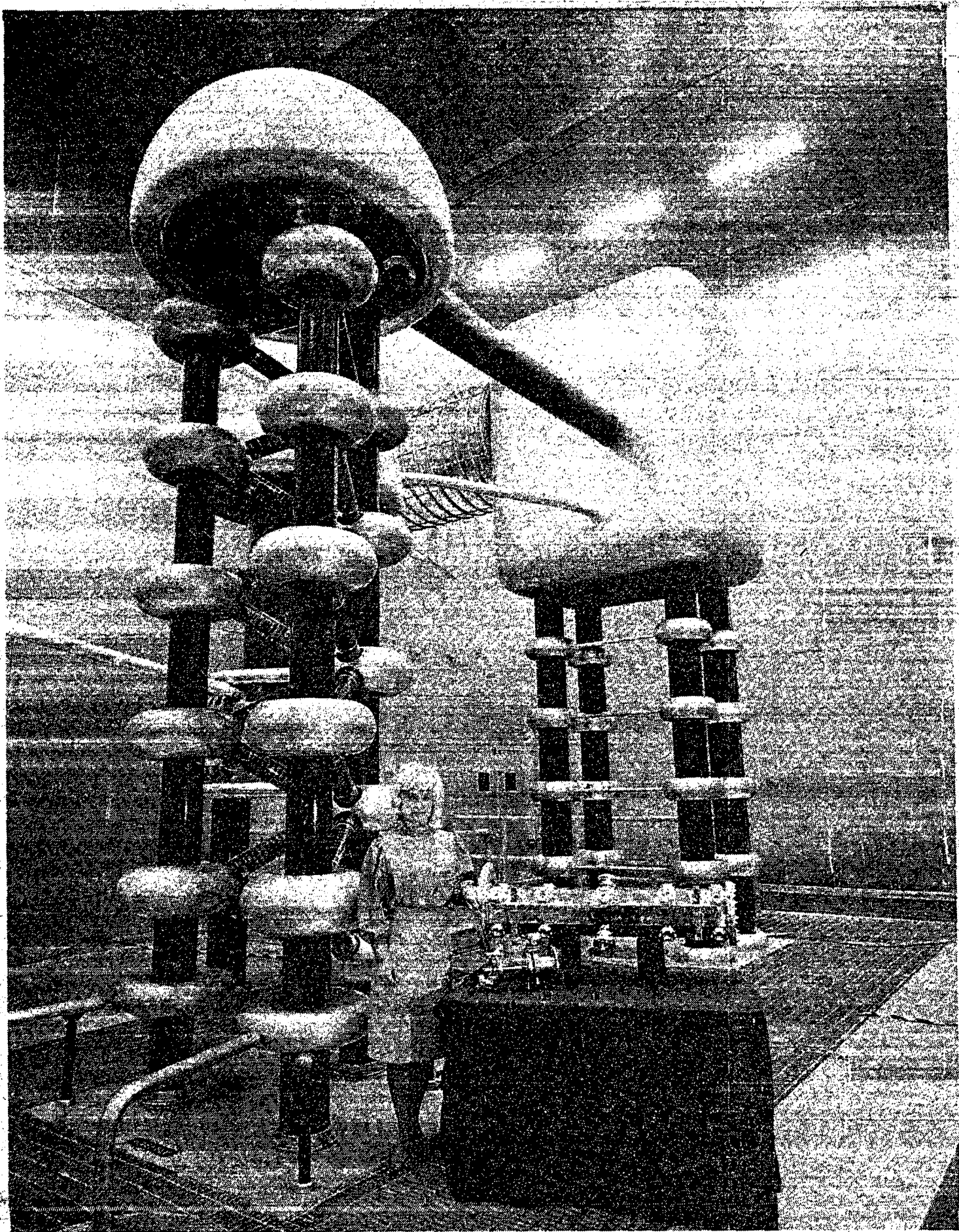

## CRNL RFQ

The cw RFQ in operation at Chalk River Nuclear Laboratories. The 270 MHz, 600 keV RFQ has accelerated 50 mA of protons cw and is undergoing extensive tests prior to operating at the limit of the rf system —75 mA.

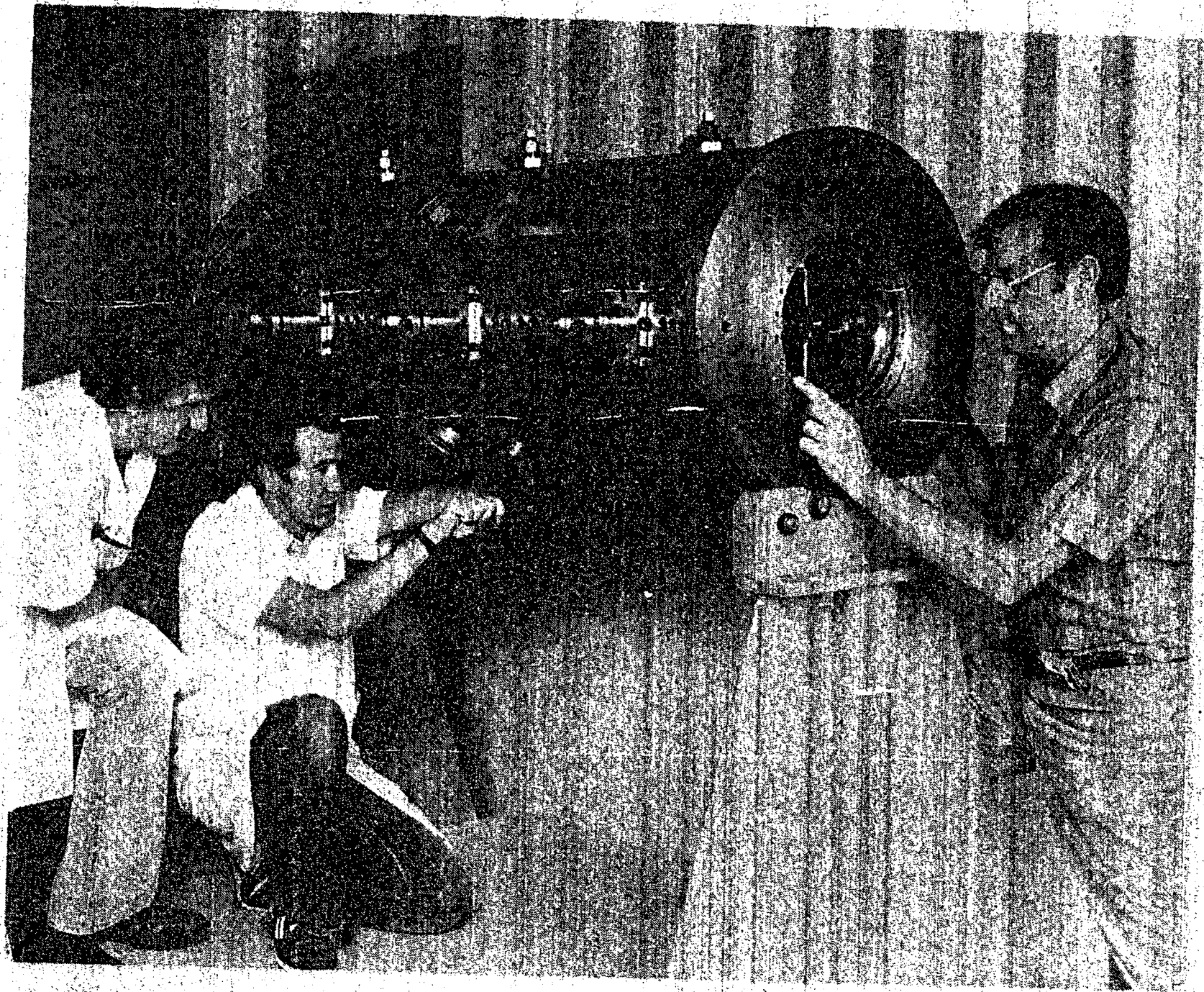

## CRNL DTL

The 270 MHz DTL that operated at CRNL for acceleration of 3 mA of protons to 3 MeV from the 750 keV injector. Lower cw currents ( $\sim\frac{1}{3}$  mA) were transported from their DTL to a prototype cw RFQ to observe changes in RFQ performance when the beam was made to impinge on the RFQ vane tips on purpose. No change was noted.



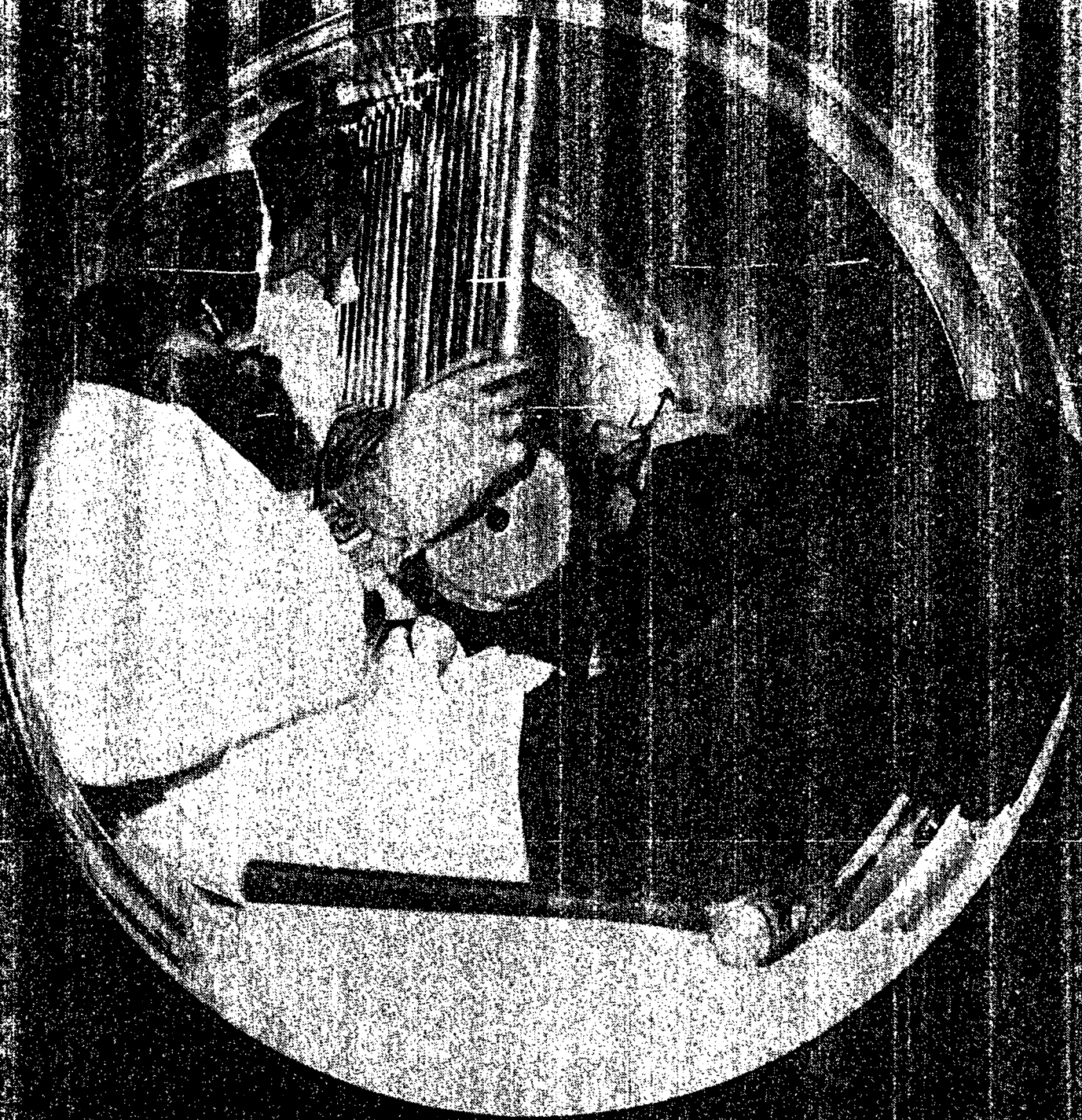

## **CCL at NIST (National Institute of Science and Technology)**

CCL sections built at LANL are operating cw at NIST on their cw racetrack microtron. These accelerating sections operate at higher accelerating gradients than that required of APT and have higher rf heat fluxes per unit area than would be experienced by APT linac sections.

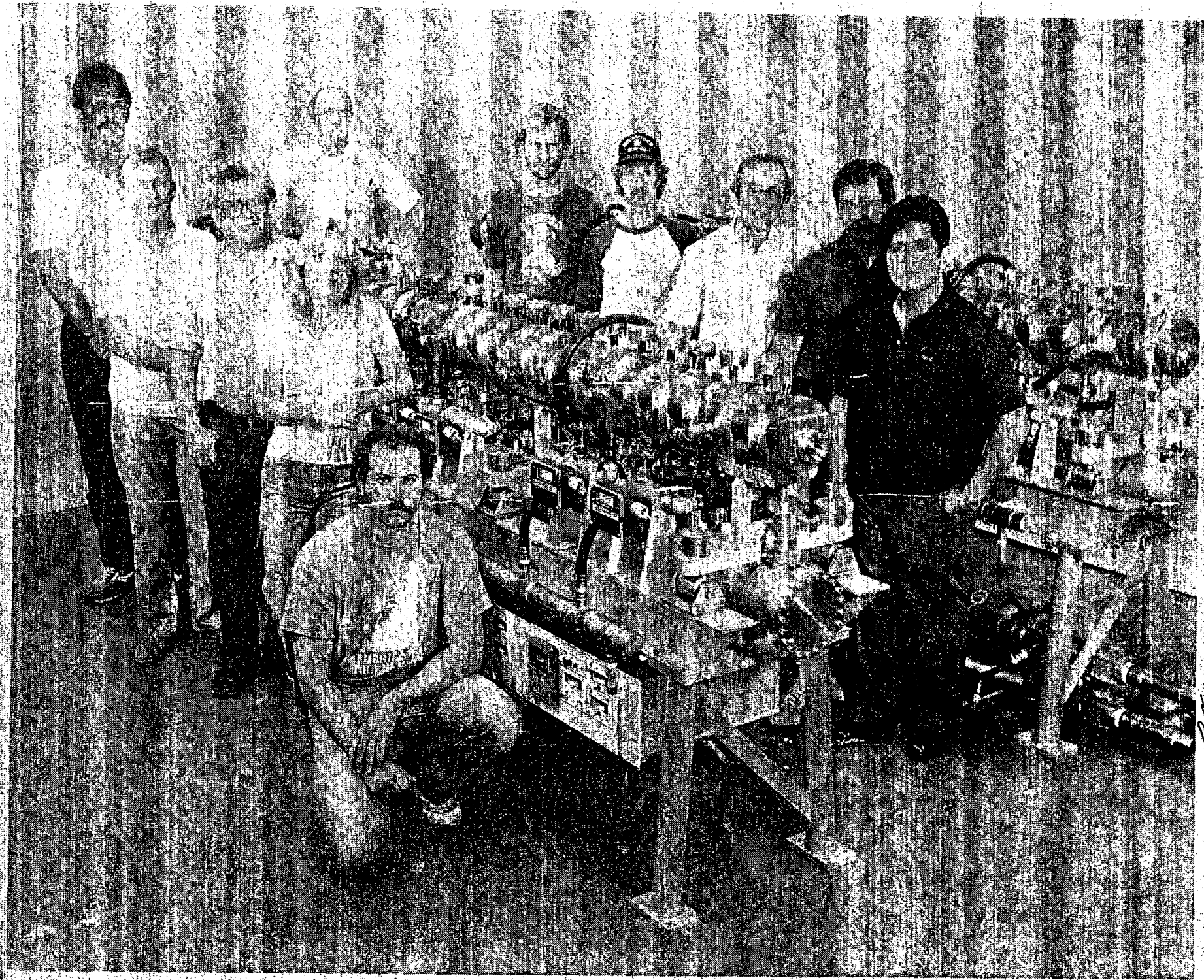

2485-4778



## **APT Transport Line Schematic**

The transport line conveys 1.6 GeV protons from the linac to either of two targets or to a low-intensity, tune-up beam stop. The linac is a periodic focusing structure with quadrupoles approximately 2.4 m apart; this focusing periodicity is retained in the first section of the transport line. A device, known as a beam transformer, matches to a periodic line with larger component spacing to allow for sufficient separation between the components of the three branches. Jitter control is planned in that section. Beam is deflected toward a target by an achromatic bending section and is then conveyed to the target by a matching section and a nonlinear beam expander. With the two 20° achromatic bends, the two targets are separated by about 50 m.

## **Linac Low-Momentum Beam Handling**

A small fraction of linac output consists of low-momentum beam. This needs to be taken into account when designing the transport line, since loss of that beam, occurring in the achromats, cannot be tolerated. Scraping of low-momentum particles is planned in the dispersive section following the first 10° dipole. The achromatic bends will have 2% momentum acceptance and particles with larger momentum deviations will be scraped. The remaining low-momentum particles will be transported to the target and affected by the nonlinear beam expander essentially in the same way as the on-momentum beam.

# APT

## APT Transport Line Schematic

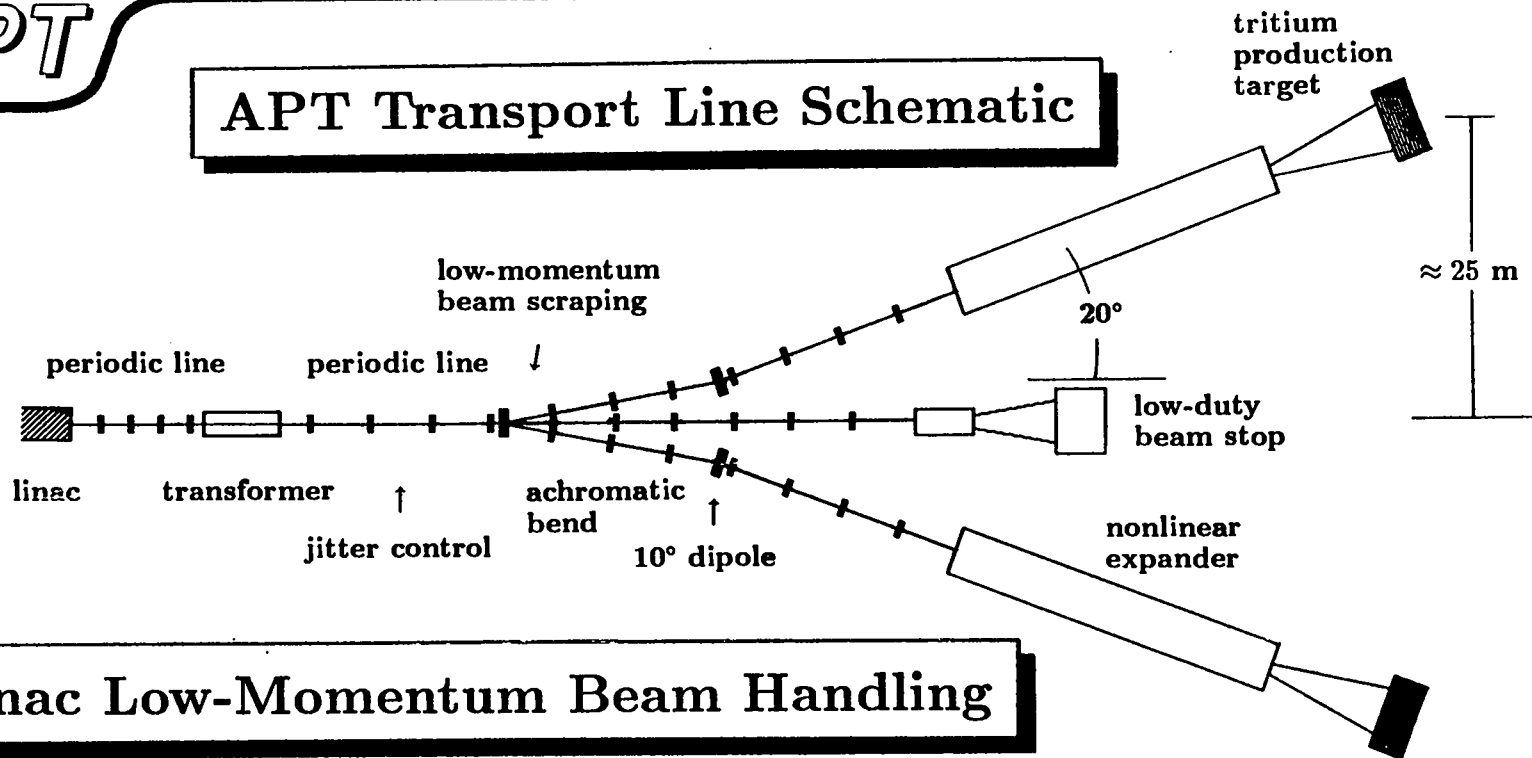

## Linac Low-Momentum Beam Handling

- Expected low-momentum intensity (scaled from LAMPF):  $10 \mu\text{A}$ ,  $\leq 16 \text{ kW}$ .
- First dipole deflects low-momentum beam by larger angle than 1.6 GeV beam.
- Low-momentum particles (up to achromat acceptance) are absorbed by scrapers following first dipole.
- Removal of essentially all particles with  $\delta p/p \geq 2\%$  is possible.
- Achromat designed with momentum acceptance of 2%.
- Performance of nonlinear expander is insensitive to momentum variation.
- Need 3-m thick carbon scraper (or 1-m thick steel scraper) to stop 1.6 GeV particles.

## Summary

- **Accelerator based method is not new**
- **Significant technical advances give improved characteristics**
- **Component demonstrations provide credible basis for reference design**
- **An integrated system has not been built —realistic interpolations and extrapolations are possible**
- **Four year development will provide basis for decision to proceed!**

**APT**

# APT Target Lattice

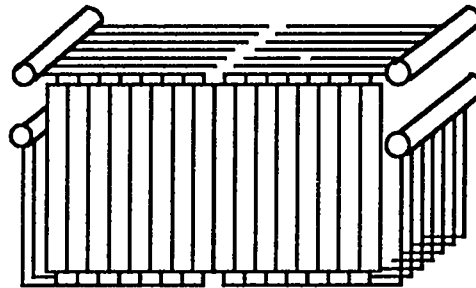

James R. Powell

Brookhaven National Laboratory

## Introduction

- Conservative Design Approach Adopted for APT Target
  - Periodic Replacement of Modular Pressure Tubes That Contain Pb and LiAl
  - No Window Between Pressure Tubes and Accelerator
  - Low Temperature, Low Pressure Coolant
  - Power Densities Comparable to Light Water Reactors
  - Materials Damage Effects are Acceptable- Ductility Maintained
  - LiAl Design and Tritium Recovery Parameters Based on SRP Experience
- Principal Issues Are:
  - Reduce Uncertainty in Neutron Yield
  - Enhance Materials Damage Data Base
  - Effect of Spallation Induced Activation on Tritium Recovery Process

# APT

## Target Assembly Beam Expander and Vacuum Vessel

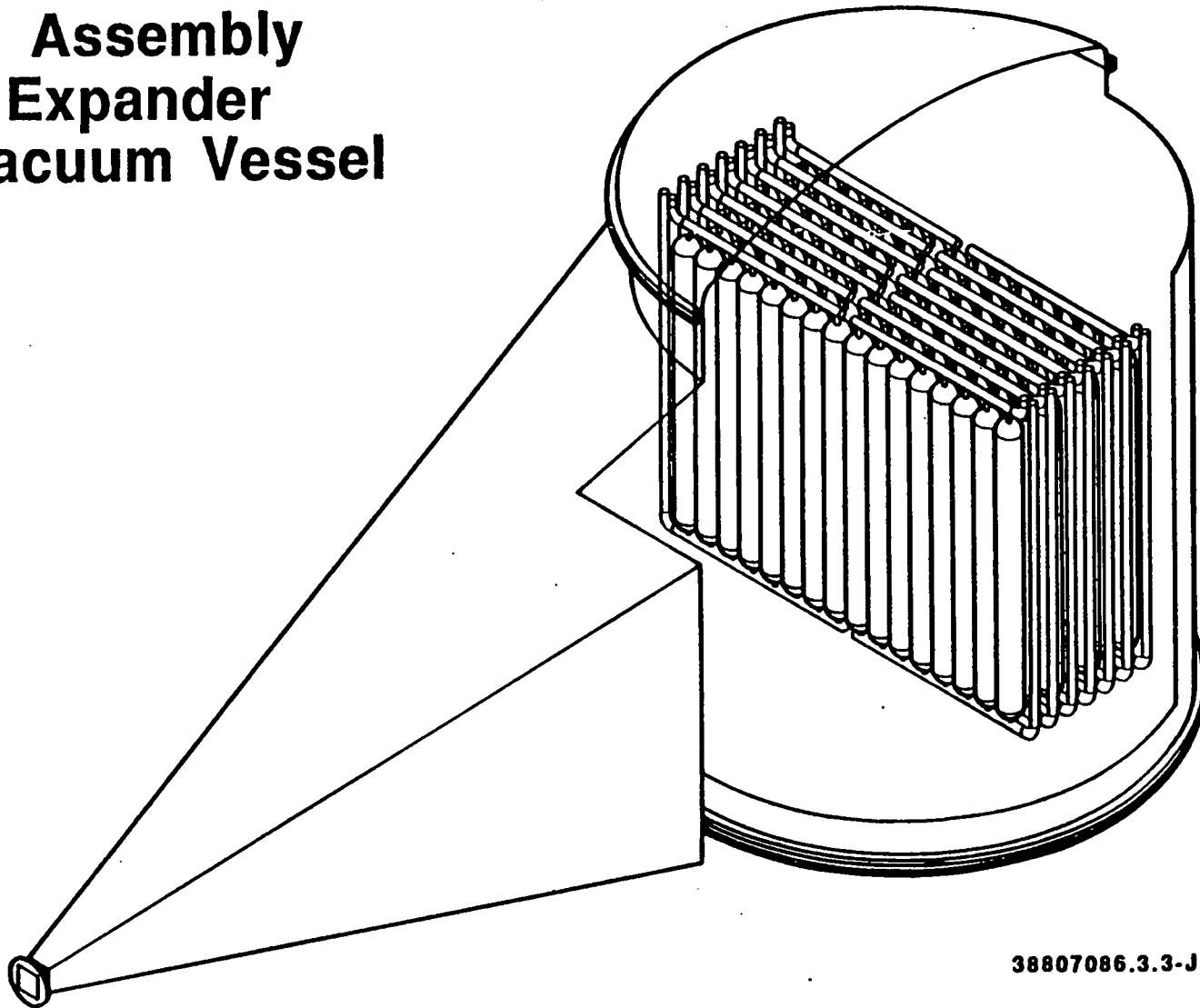

38807086.3.3-JP

Los Alamos - Brookhaven

## Target Design Approach

- SRP LiAl Technology for Tritium Generation/Recovery
- Use Well Characterized Materials
- Low Temperature, Low Pressure Water Coolant System
- Target Lattice Readily Removable/Replaceable

## Target Design Features

- Lattice of Removable Stainless Steel Pressure Tubes
- Pressure Tubes Contain Integral Bundle of Pb & LiAl Rods (Nominal 2/1 Ratio)
- Light Water Coolant
  - Low Pressure (~150 PSI)
  - Low Outlet Temperature (~120 C)
- LiAl Rod Design Based on SRP Experience
  - Aluminum Clad
  - Li Content ~3% (Weight), 50% Li-6 Enriched
  - Low Temperature (~130 C)
  - Acceptable Gas/Volume Ratio (GVR) [ <130]
- Tritium Recovery By Heating LiAl Rods
  - Separated From SS Pressure Tubes & Pb Rods
  - SRP-Type Processing Unit
- Pressure Tubes Always Ductile
  - 6 Month Replacement Interval For First 2 Rows
  - 12 Month Interval For Back Rows



# APT

## Lattice Assembly

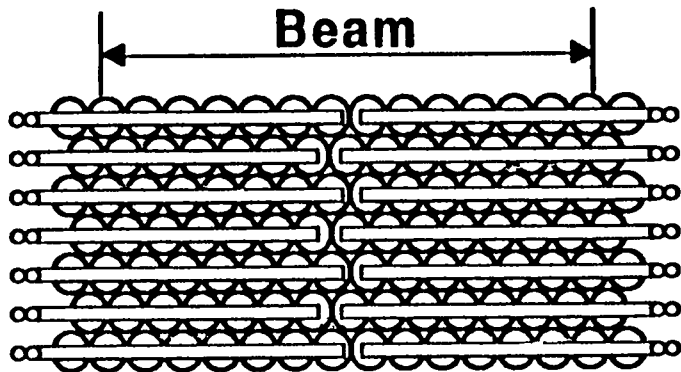

7 Banks, 0.30 m  
Pressure Tube,  
16 Pressure Tubes/Bank

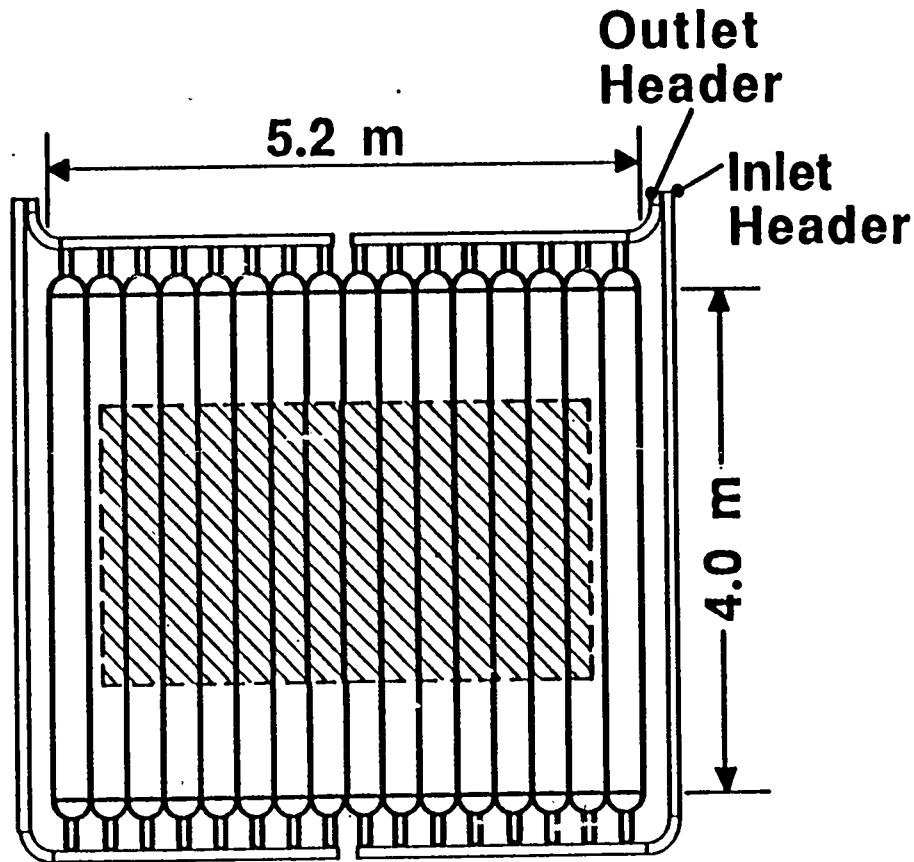

Target Assembly  
Beam on Target 2 x 4 m

# APT

## Cross Section of Pressure Tube

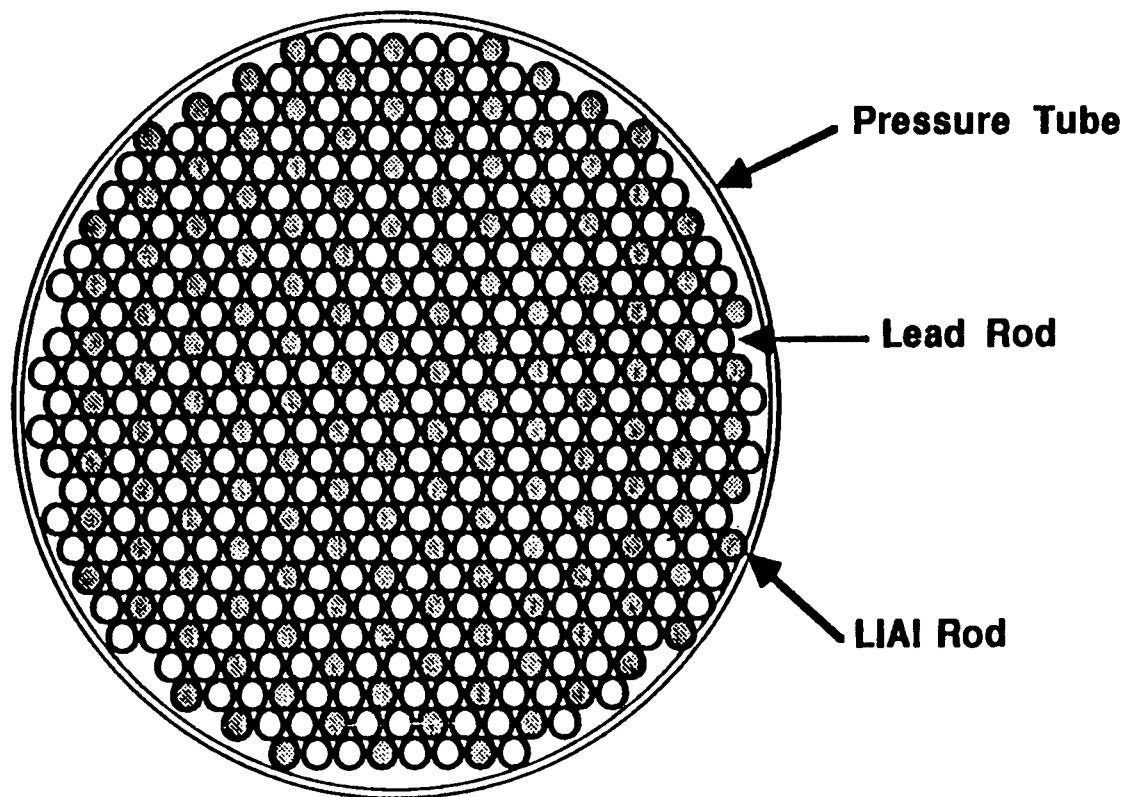

Tube Diam.-30 cm  
Rod Diam.-1 cm  
No. of Rods-570  
Pb/Li Al Rods -2:1

38807083.3.5JPM

Los Alamos - Brookhaven

## APT Lattice Parameters

### Lattice frontal area

- Beam impact area 2 x 4 meters
- Overall size 4 x 5.2 meters
- Number of tubes 16

### Lattice depth

- Number of rows 7
- Total number of tubes 106
- Depth 2.1 meters

### Pressure vessel

- Diameter 8 meters
- Height 8 meters
- Wall thickness 10 cm
- Material Stainless steel

### Internal Shield

- Minimum thickness 1.0 meter
- Composition 80% SS/ 20% H<sub>2</sub>O
- Total volume shield 226 cubic meters
- Void volume in vessel 149 cubic meters

## Target Topics/Issues

### Topic

---

- Tritium Production Capability
- Materials Damage Limits
- Lattice Coolant System
- Handling of Irradiated Targets
- Radwaste Characteristics
- Safety

### Issue

---

- Uncertainty in Neutron Yield from High Energy Protons
- Sparse Data Base
- Assure Vacuum System Integrity
- Effects of Spallation Activities on Tritium Processing
- Quantities & Characteristics
- Shut Down Beam Promptly

# APT

## Tritium Production Estimates

- Each 1.6 GeV Proton Generates \_\_\_ Primary Neutrons In Lattice, on Average
  - Reactions Energy  $> 17$  MeV
  - Spallation, Fragmentation, Evaporation, and Secondary [e.g., (N, xN)]  
Reactions in Pb, SS, Al, H<sub>2</sub>O, and Li
- Primary Neutrons Transport in Lattice, Each Producing \_\_\_ Tritium Atoms on Avg.
  - Reaction Energy  $< 17$  MeV
  - Absorption (Li-6, SS, etc.), (N, 2N), and Leakage Processes
- Lattice Produces 100% of Goal (\_\_\_ kg/yr) Based On:
  - 1.6 GeV
  - 250 mA
  - 75% Plant Factor
- Relative Production In Lattice Is:
  - 3% Leakage from Front Face (Lost Unless Neutrons Are Reflected)
  - 38% First Row (Assumes 10 cm Be/LiAl/H<sub>2</sub>O Front Reflector)
  - 31% Second Row
  - 31% Back Rows

Los Alamos - Brookhaven

## Tritium Production Estimates - Analytical Methods

- 3-D Monte Carlo Intra-Nuclear Cascade (HETC) Above 17 MeV
  - Calculates Primary Neutron Yields and Spatial/Spectral Distributions Resulting from Proton Irradiation of Lattice
  - Compared Against High Energy Proton Experiments
- 3-D Monte Carlo Point Cross Section Code (MCNP) Below 17 MeV
  - Calculates Tritium Production in Lattice
  - 3-D Explicit Representation of Lattice Rod/Tube Geometry
  - Accounts for Neutron Leakage and Absorption
  - MCNP/ENDFB-V with  $S(\alpha,\beta)$  Neutron Scattering in Water
  - Best Available Computational Technique - Errors  $\sim \pm 5\%$

## Neutron Yield Issue

- Neutron Yield Data for Lead is Sparse for Proton Energies  $> 200$  MeV
  - Primarily Rely on 1964 Cosmotron Data for Small Diameter Targets (Reduces Yield + More Sensitive to Beam Misalignment)
- 1964 Experiment Yields Below HETC/NMTC Predictions
  - Gold Foil Data  $\sim 18\%$  Lower (Includes Complex Analysis)
  - Beta Current Data  $< 10\%$  Lower
  - Experimental Procedures, Calibration, etc. Not Fully Documented
- Goal: Reduce Uncertainty in Yield to  $\pm 5\%$

# APT

Neutrons/Incident Proton

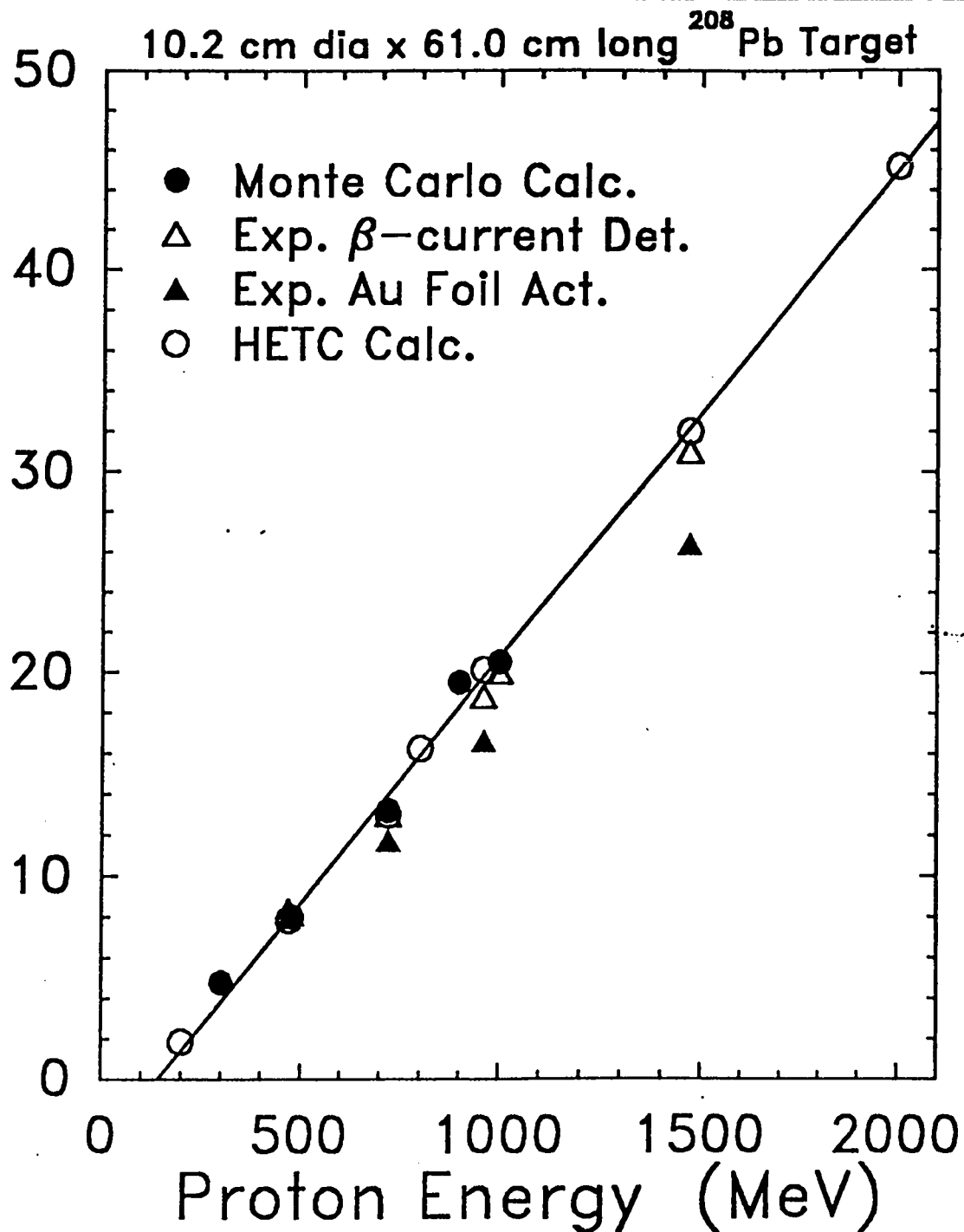



**APT**

## Resolution of Neutron Yield Issue

- Perform Neutron Yield Measurements on Range Thick, Large Diameter Lead Targets
  - Measurements at 1.5 GeV (Existing Facility)
  - Double Differential Cross Sections (Energy and Angle)
- Perform Neutron Yield Measurements on Prototype APT Lattice
  - Energy Range Up to 1.5 GeV (Existing/Planned Facilities)
  - Measure Neutron Yield (Both Lattice and Pure Target Materials)
  - Measure Tritium Production Rate At/Near Design Energy (Several Months)

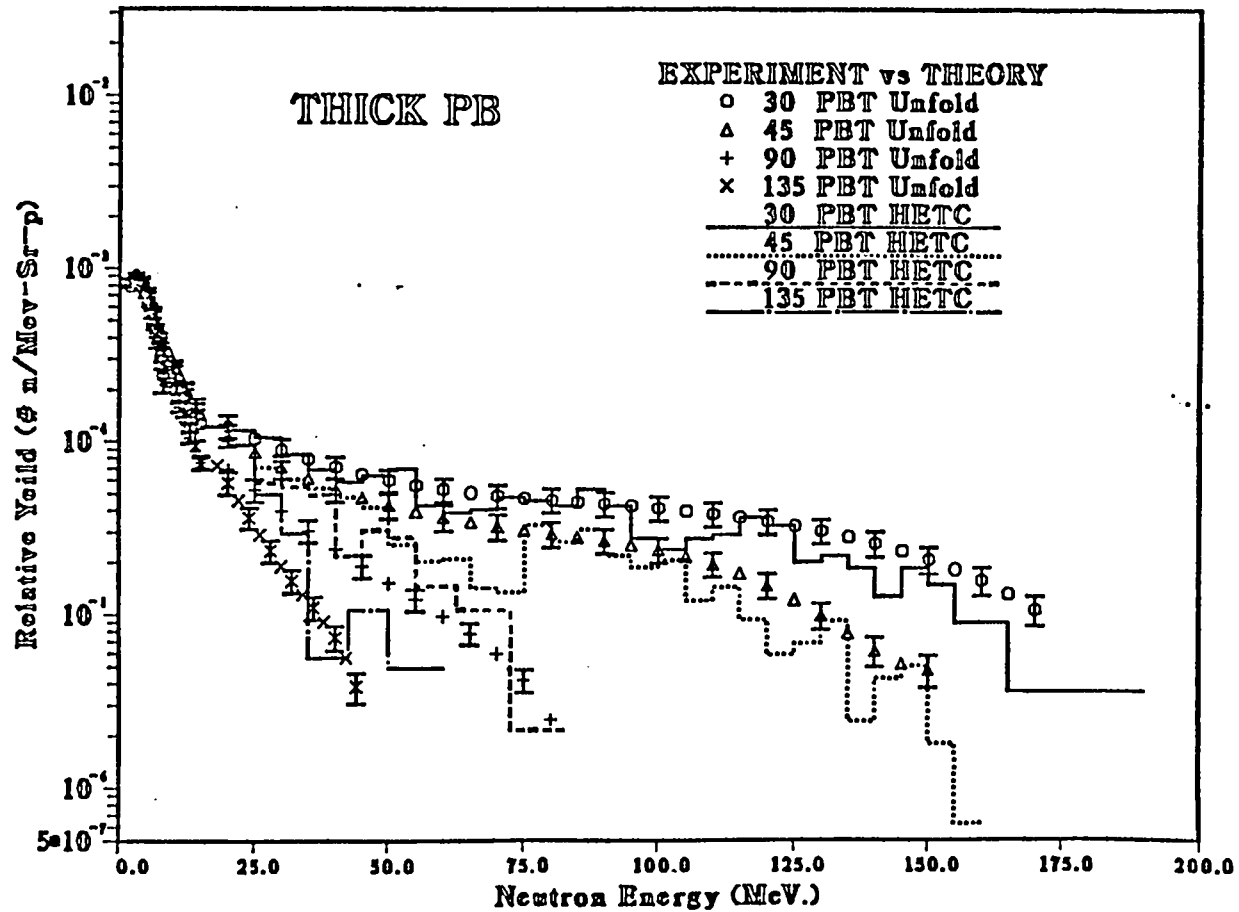

# **APT**

## **Lattice Materials**

- **Lattice materials affected by proton beam and high energy neutrons**
- **Suitable lattice materials are**
  - **Pressure tube - 316 stainless**
  - **Cladding for Pb and LiAl - Aluminum Alloy (6061)**
- **Pressure tubes removed along with lattice rods**
- **Lattice materials are suitable for planned exposure cycle**
  - **Stainless tubes remain ductile**
  - **Low primary stress**
  - **LiAl has maximum tritium concentration of ~20,000 appm**

38807086.3.13M-JP

*Los Alamos - Brookhaven*

# APT

## Gas Generation and Displacements/Atom in 316 SS Pressure Tube

First Row, Assuming 75% Plant Factor, 250 mA, 2x4 M Beam Area

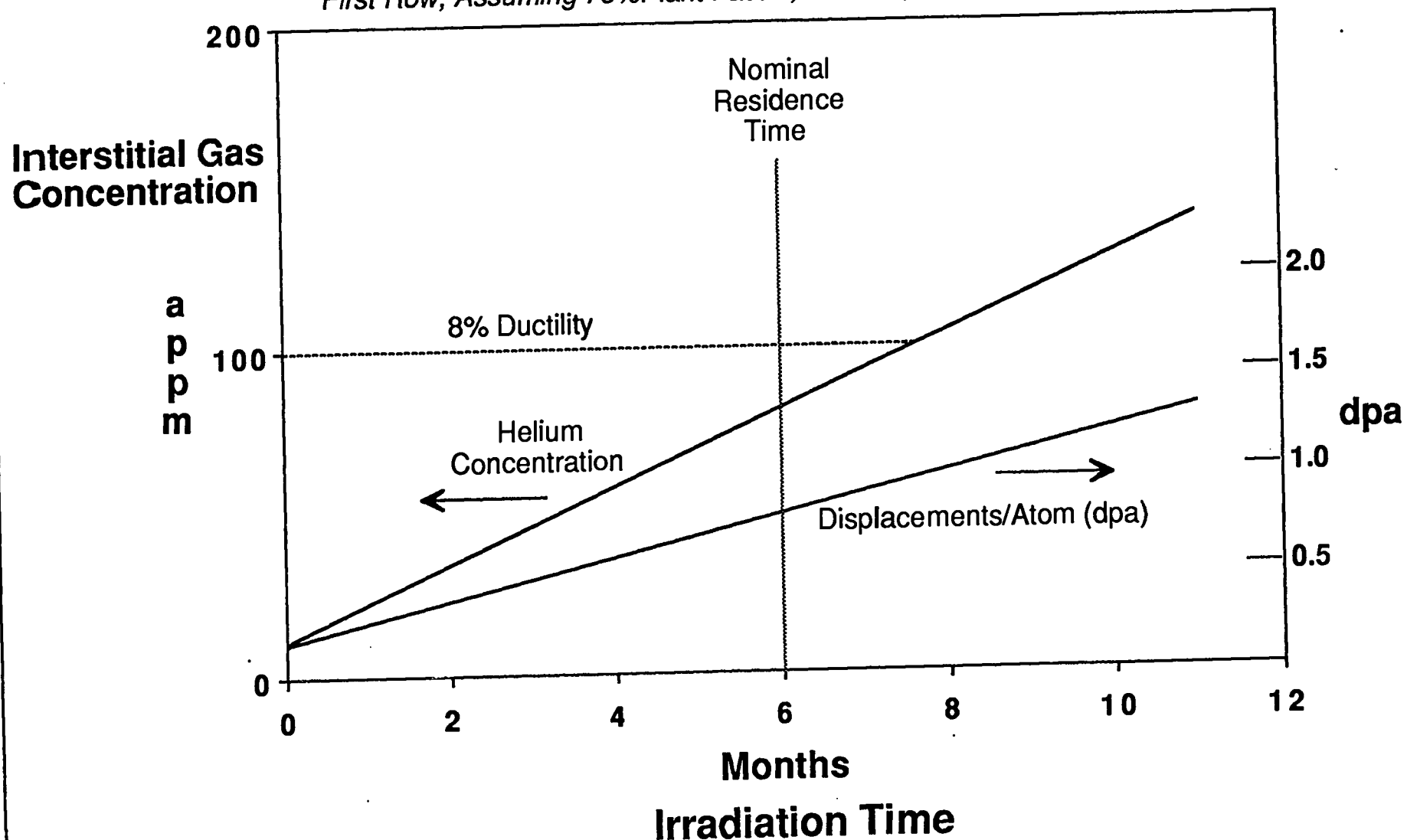

Los Alamos - Brookhaven

## Proposed Expansion of Materials Data Base

- Stainless Steel: Current Choice is 316-L
  - Avoid Nuclear Grade, as Additional Nitrogen Would Increase Gas Build-Up and Embrittlement
  - Irradiate to 50 - 150 apm Helium
- Aluminum Alloys: Test for APT Conditions
  - 6061 Good Under High Neutron Fluences
  - High Purity 1100 Used at SRP for Li-Al Cladding
- LiAl (Adapted from SRP): Test Under APT Conditions
- Aluminum Cladding with Lead: Spallation Product Incompatibilities? (e.g., Hg)
- Most Testing Would Be at LAMPF. Some at EBR-II or FFTF ?

## Thermal-Hydraulic Parameters in First Row of Pressure Tubes Basis: 140 w/cubic cm Power Density (2 Meters Heated)

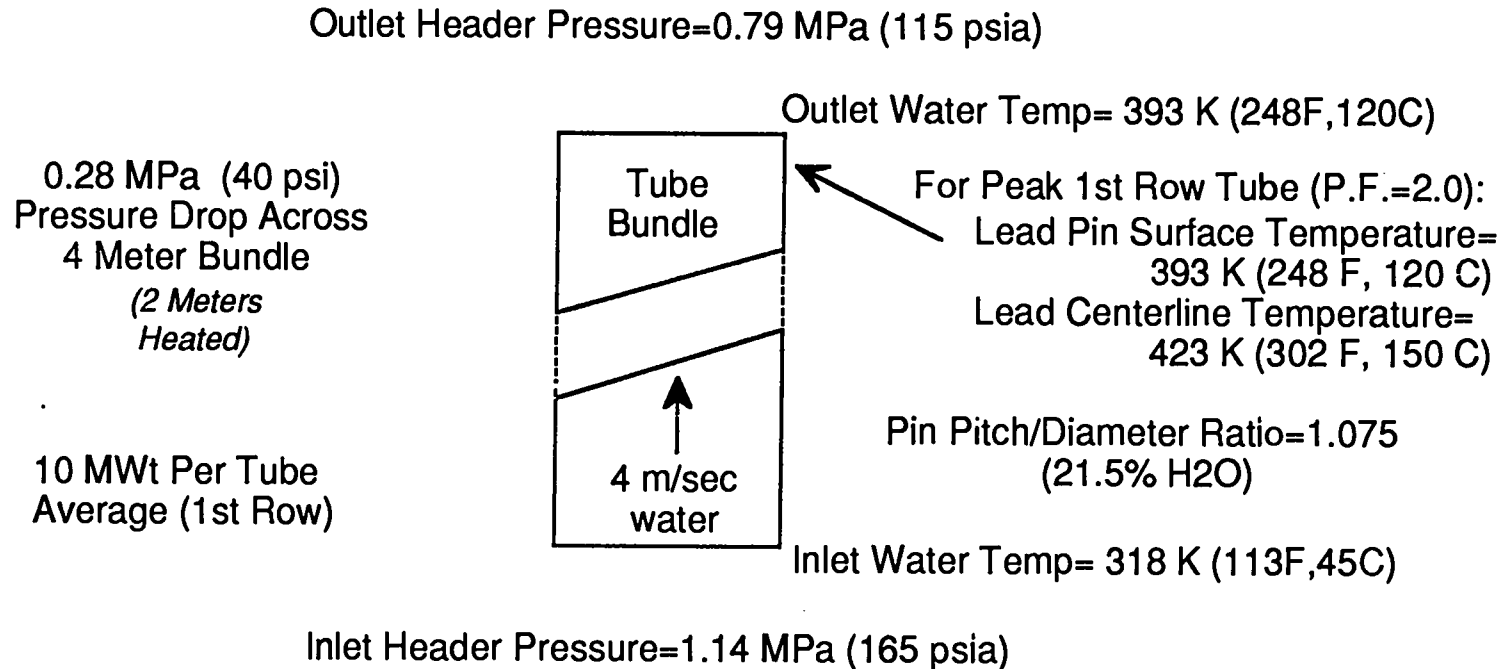

- Subsequent Rows of Tubes Have:
  - Smaller Pitch/Diameter Ratios [1.05 (17.7% H<sub>2</sub>O)]
  - Lower Pressure Drops [ $<0.28$  MPa (40 psi)]
  - Lower Outlet Temperatures [ $<375$  K (216 F, 102 C)]
- Mixed Mean Outlet Temperature For All Rows Approximately 375 K

# APT

## Lattice Cooling System

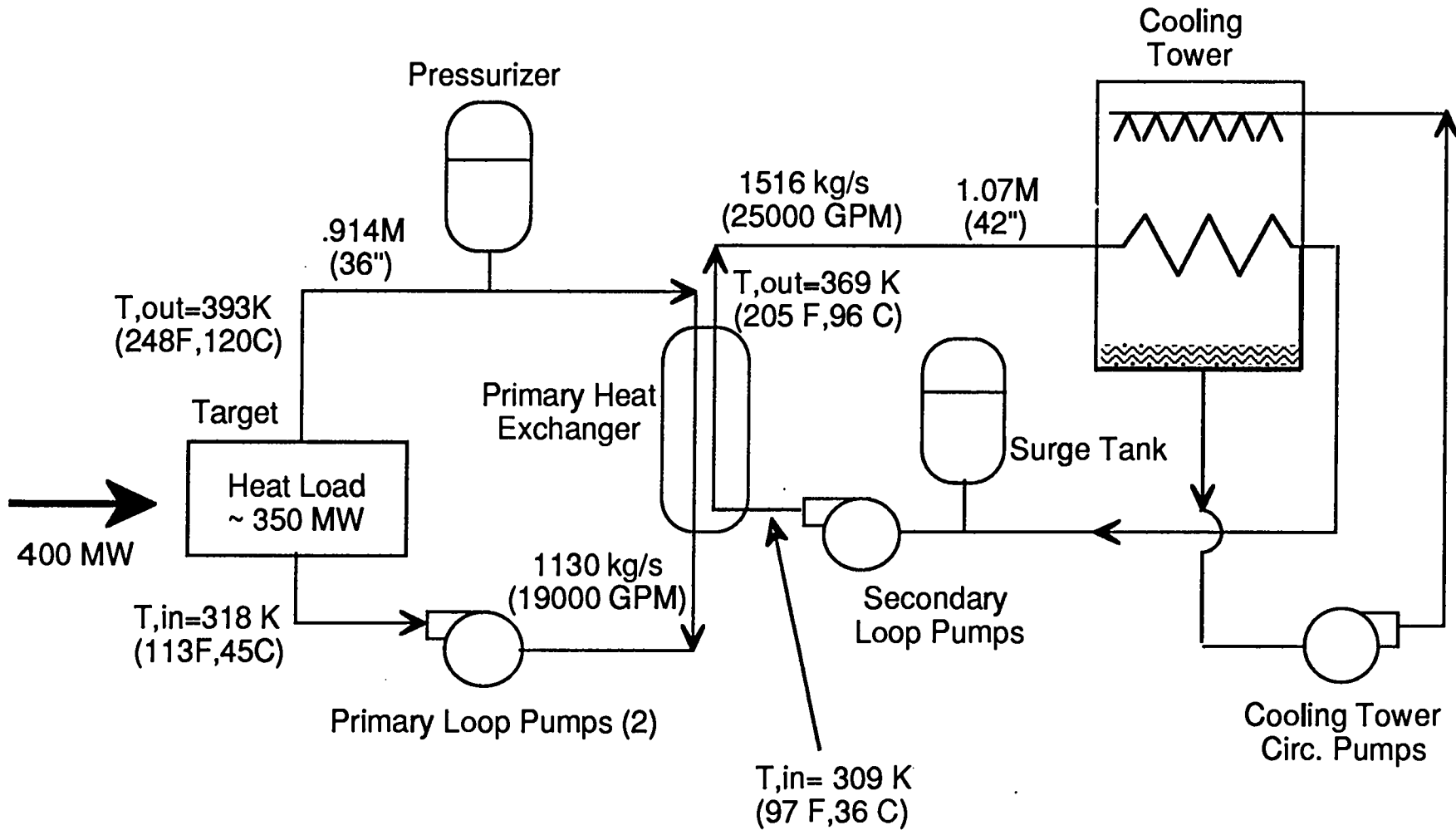

# APT

## Lattice Vault Building

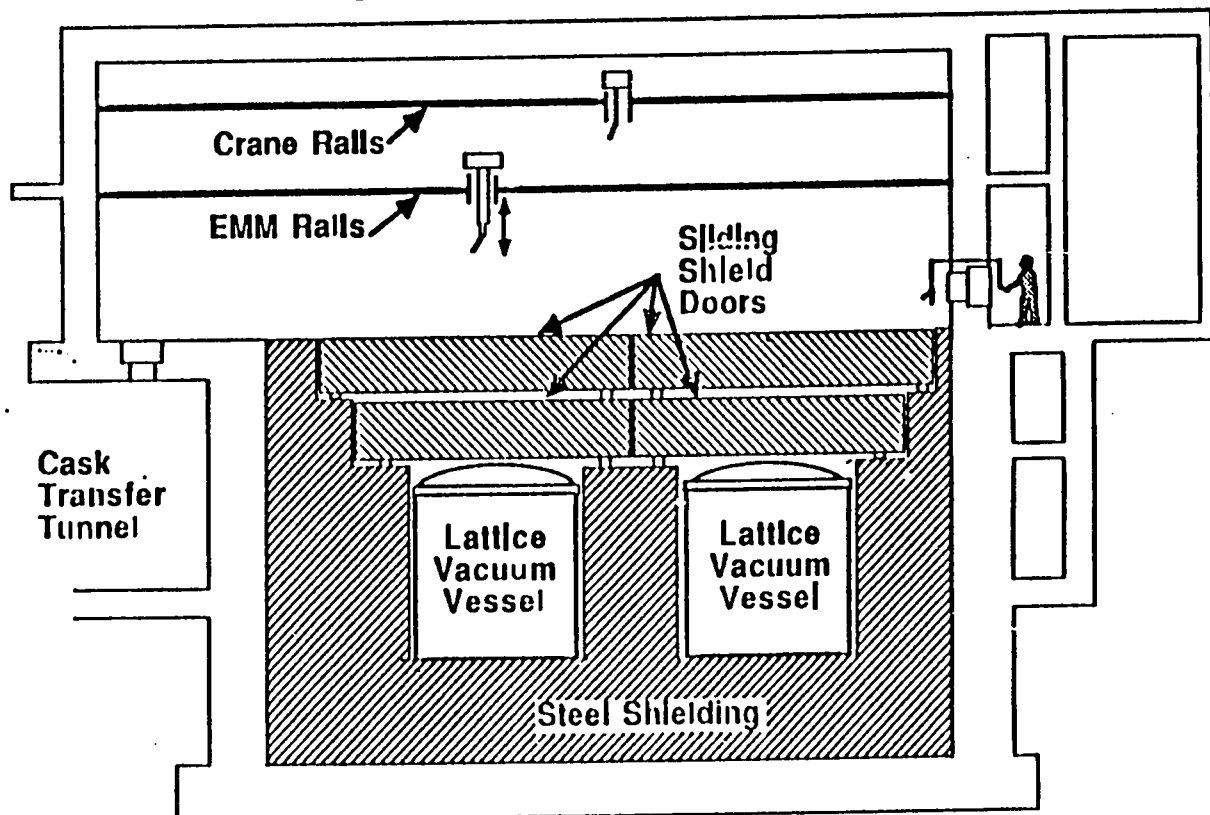



# APT

## Lattice Handling Schedule

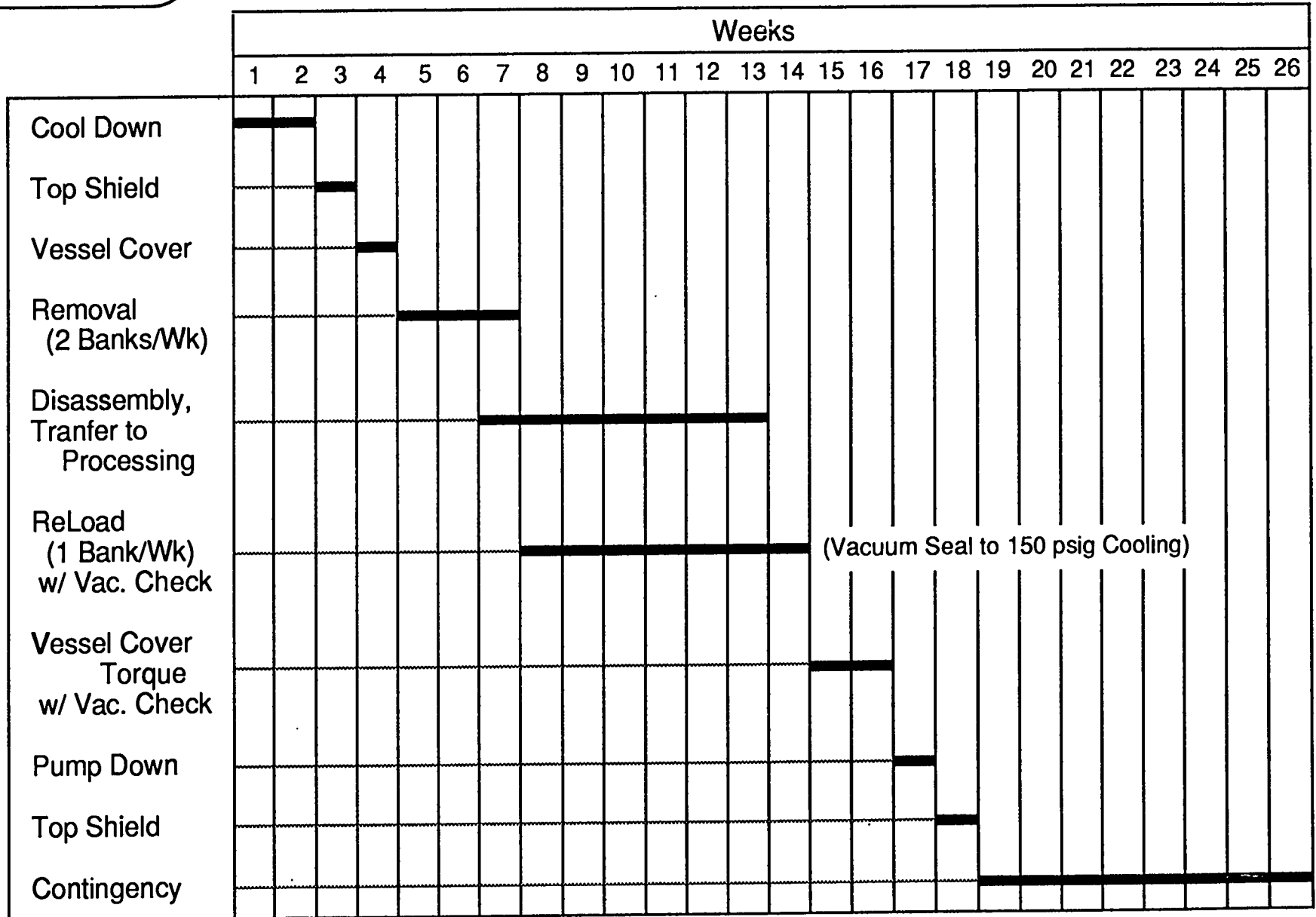

**APT**

# Lattice Operation Cycle

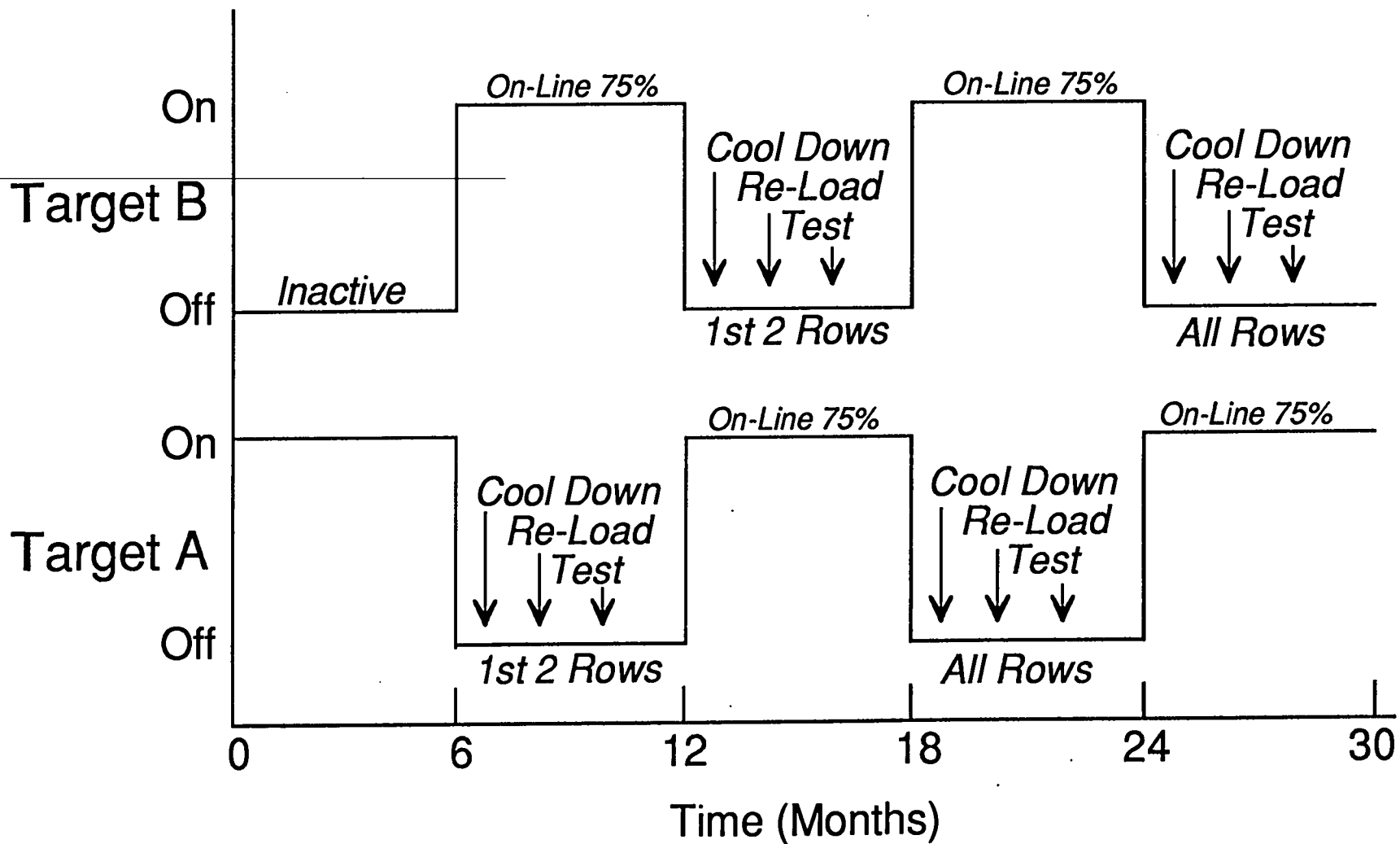

## Tritium Processing Issue

- LiAl and Al Cladding in APT Appear to Have Additional Radioactivity Compared to HWR Reactors
  - Na-22 Present (2 Year Half-Life)
  - ~0.1 MegaCurie Inventory in Target Aluminum
- Additional Decay Time May Be Needed Before Disposal
- Effect on Tritium Recovery Process Equipment Has Not Been Evaluated

## Resolution of Tritium Processing Issue

- Discuss with SRP Experts
- Quantify Additional Radioactive Source Terms
- Examine Impact on Process Equipment and Procedures
- Perform Experiments on Na-22 Transport, If Necessary

Total Radioactivity from  
Target Components  
Based on HETC/MCNP+Origen2

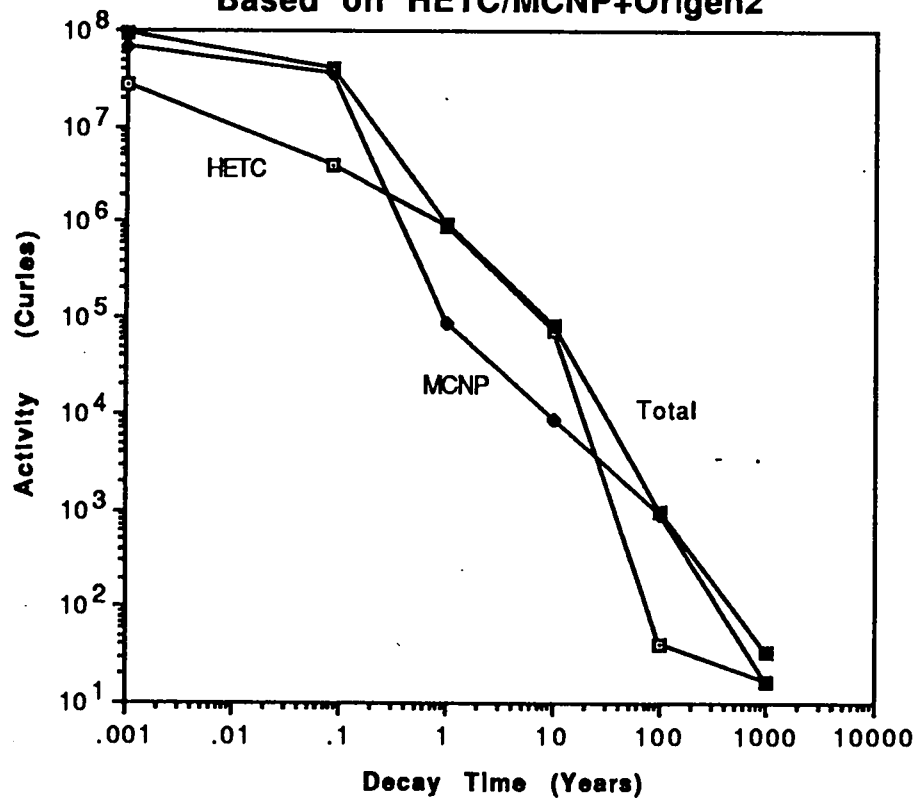

## APT Radioactive Waste Quantities

*Basis: 1 Year Operation*

Material	Compacted Volume (Cubic Meters)	Activity After 10 Years (Curies)
Stainless Steel Pressure Tubes with Lead Rods	20	100,000
LiAl with Al Clad	10	10,000

## Lattice Safety Features

### Inherent Safety Features

Large Water Inventory

Very Low After Heat

Non-Fissile Lattice

Low Residual Radioactivity

Two Modes of Natural  
Convection Cooling if  
Pumps Fail

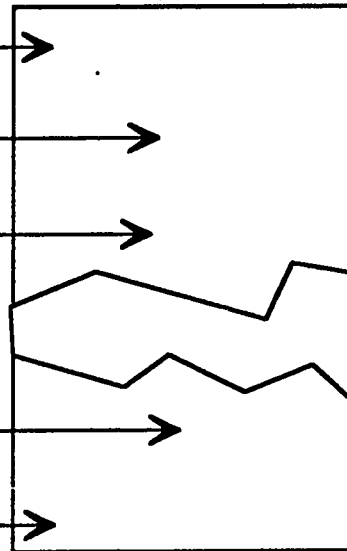

### Engineered Safety Features

Fast Shutoff of Proton Beam  
[ <1 ms]

Target Auxiliary Cooling  
System (TACS)

Vacuum Vessel (Can Be  
Filled With Water)

Pressure Tube

# APT

## Comparison of NPR and APT Decay Heat

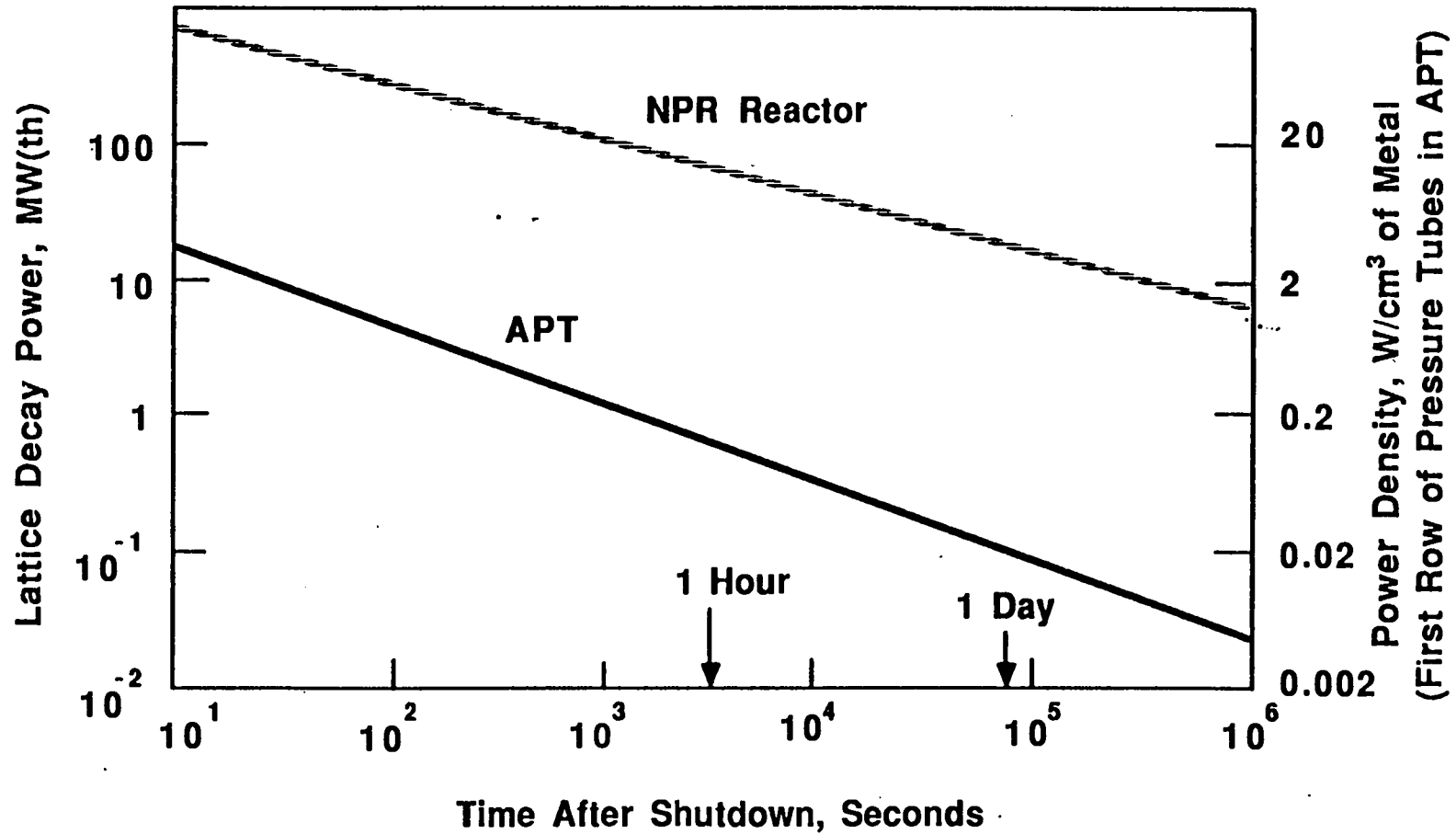

38807086.3.15M-JP

Los Alamos - Brookhaven



# APT

## Target Auxiliary Cooling System (TACS)

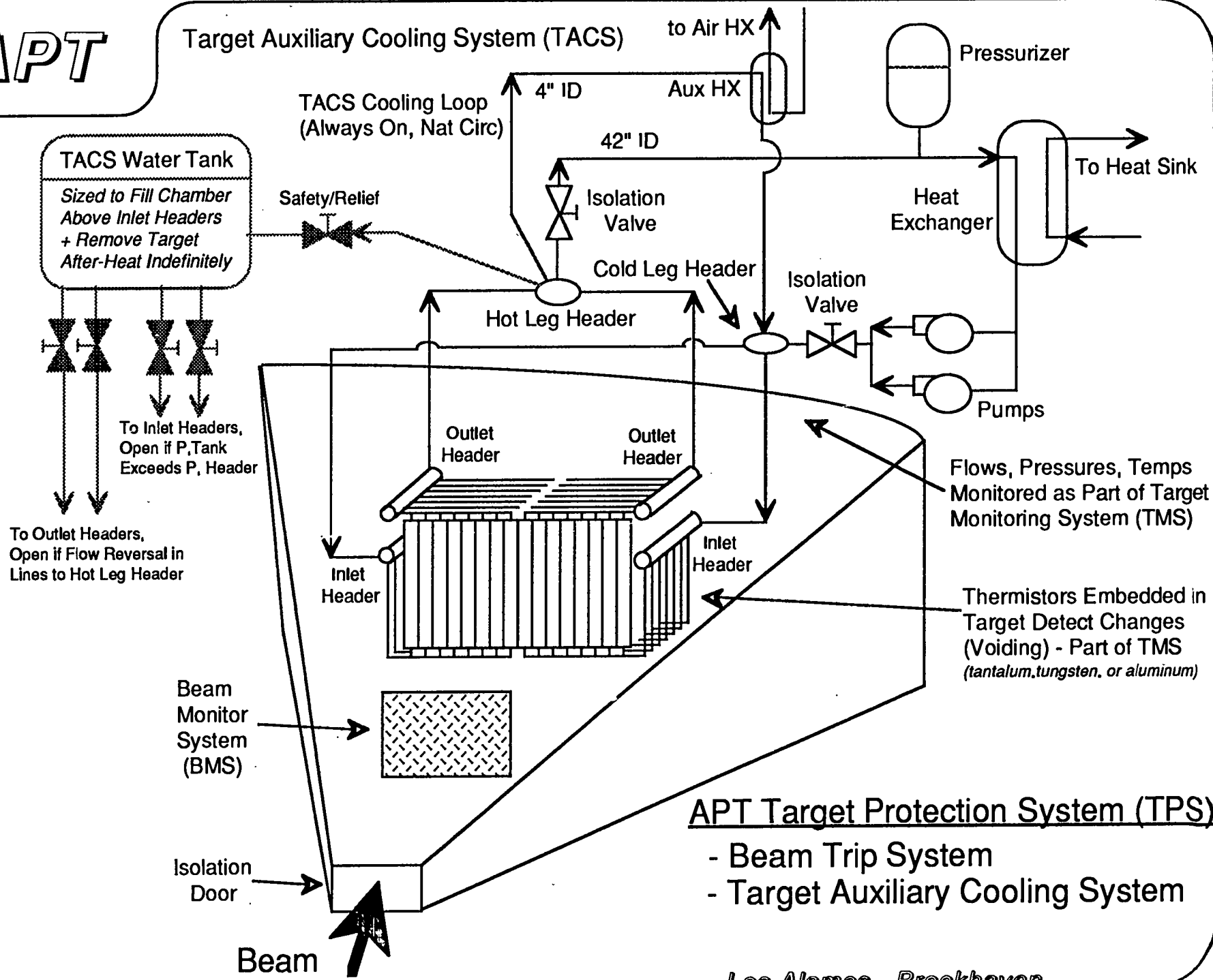

## APT Target Protection System (TPS)

- Beam Trip System
- Target Auxiliary Cooling System

## Design Basis Accidents

- Beam Focus Event - Worst Failure of Any Magnet
- Changes In Target Coolant System
  - Change In Pumping Events
    - .. Both Pumps Trip and Coast Down (Loss of Power?)
    - .. One Pump Seizes (Other Continues Operating)
  - Flow Blockage Event (of a Pressure Tube)
  - Loss of Coolant Accidents
  - Loss of Heat Sink Event (All Heat Removal Through HX Stopped)
  - Inadvertent Closure of 1 or 2 Isolation Valves
  - Inadvertent Opening of One Valve To/From TACS Water Tank

## Beam Focus Event

- Detection:
  - Beam Monitor System (BMS), (Very Fast)
  - Target Monitoring System (TMS)
    - .. In-Target Thermistors (Relatively Fast)
    - .. Coolant Conditions (Slow)
- Cooling Mode: Normal
- Analysis: How Fast Must Beam Be Stopped?
  - Depends On Degree of Focus
- Conclusions:
  - Beam Monitor System Must Detect To Prevent Damage
  - Detection by TMS In-Target Thermistors Could Prevent Wide-Spread Damage

# APT

## Beam Focus on Face of Target Lattice

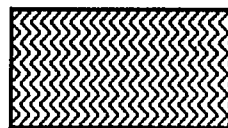

Normal Beam



1/2 Vertical

*Hotter Pins*



1/2 Across

*Hotter Tubes*

*Principal Concern*



Dual Failure

*Improbable*

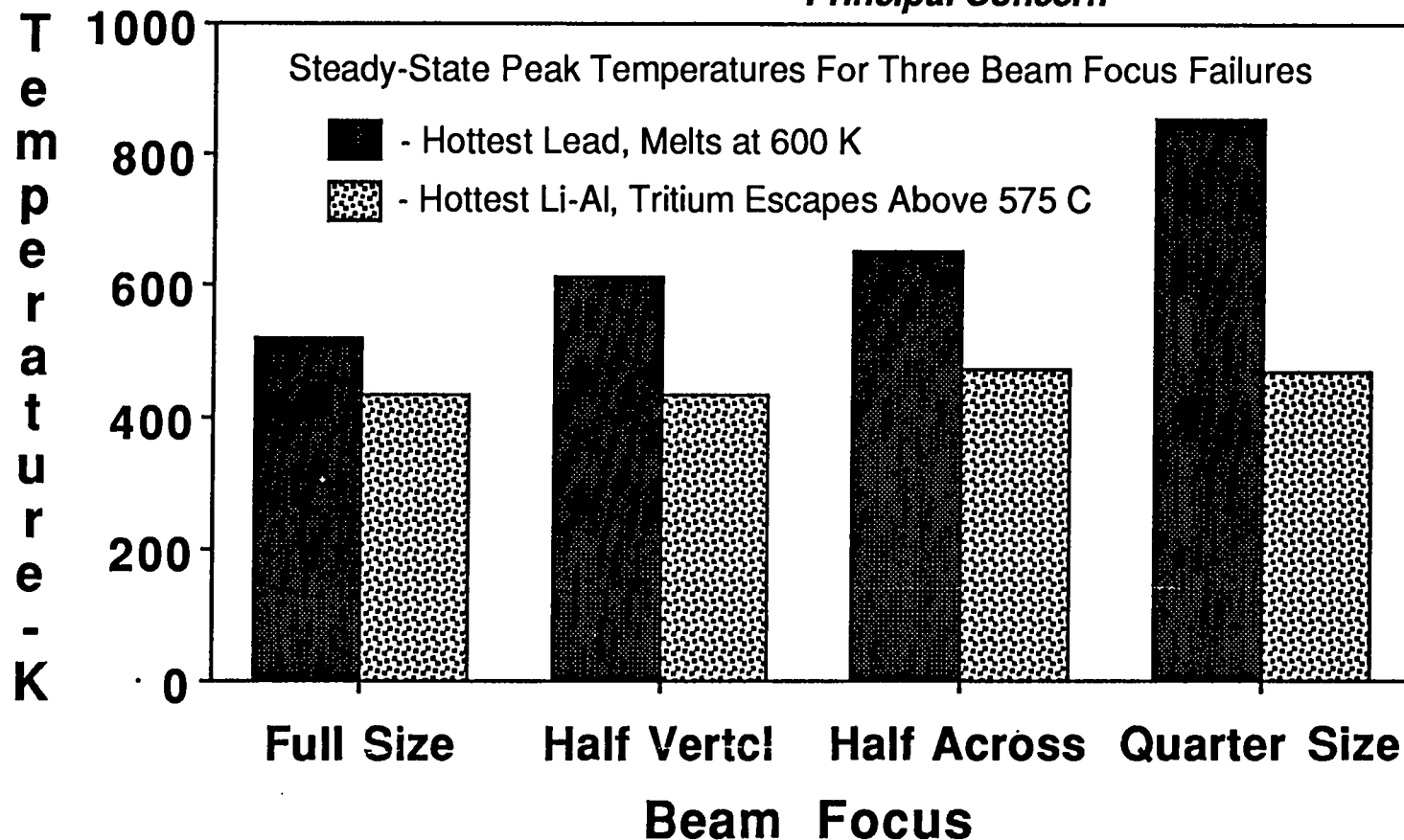

Note: Assumes Perimeter Zone Peaking Remains at 2.0

Los Alamos - Brookhaven

# ***APT***

Time After Beam-Shift Before Lead Begins To Melt

*Note: Assumes Initial Beam Peaking of 2.0 Maintained*

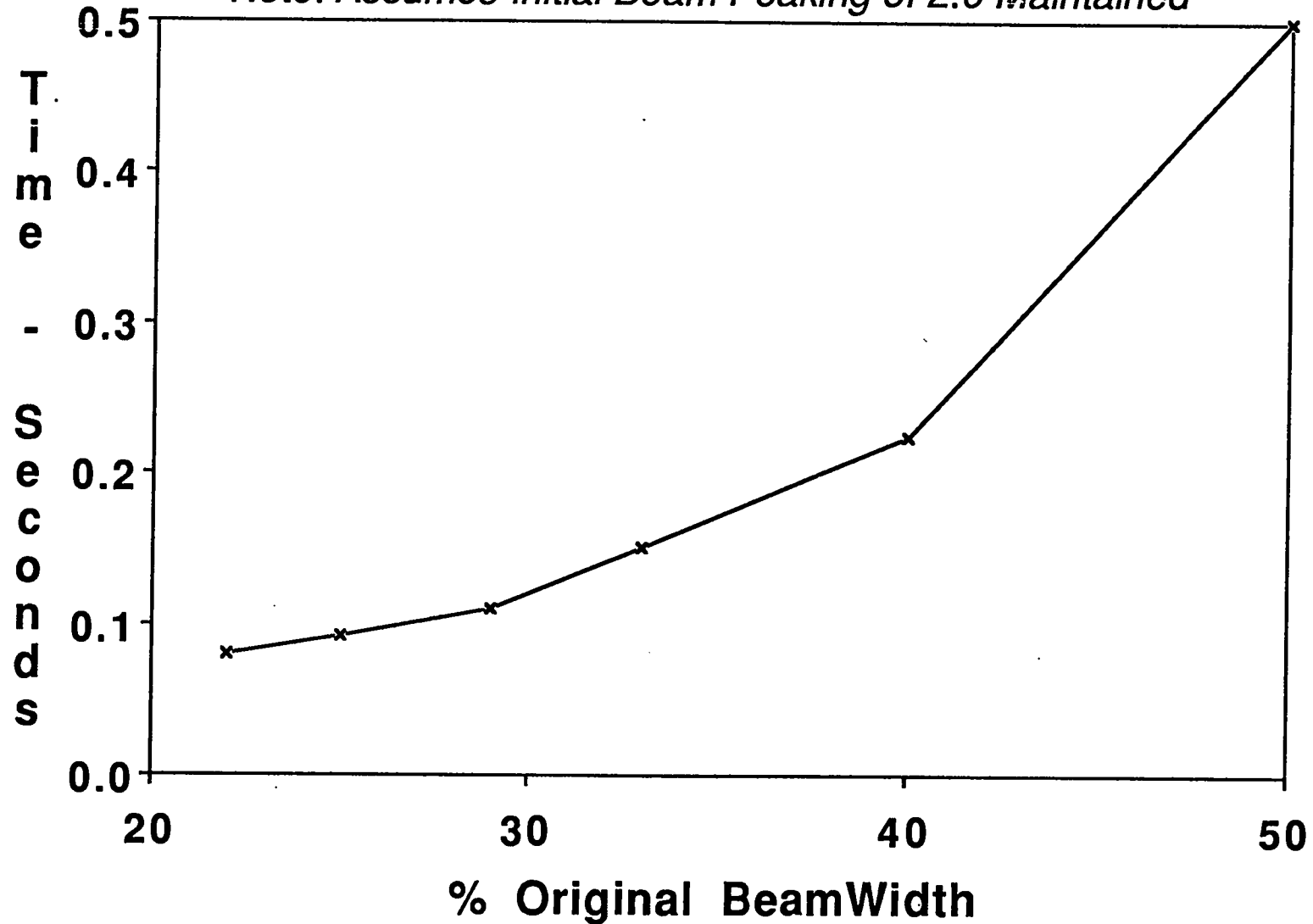

Conclusion: If Beam Can Be Inadvertently Focused in 20% Range,  
Must Assure Beam Trip In 50 milliseconds or Less (Feasible)

## Summary

- Conservative Design Approach Adopted for APT Target
  - Periodic Replacement of Modular Pressure Tubes That Contain Pb and LiAl
  - No Window Between Pressure Tubes and Accelerator
  - Low Temperature, Low Pressure Coolant
  - Power Densities Comparable to Light Water Reactors
  - Materials Damage Effects are Acceptable- Ductility Maintained
  - LiAl Design and Tritium Recovery Parameters Based on SRP Experience
  
- Principal Issues Are:
  - Reduce Uncertainty in Neutron Yield
  - Enhance Materials Damage Data Base
  - Effect of Spallation Induced Activation on Tritium Recovery Process

# **APT**

## **APT SUMMARY**

- **APT is a moderate risk nonreactor approach to provide backup subgoal or goal tritium production**
- **Development program should be initiated to address key technical issues in accelerator and target**
- **Additional studies should be performed to determine trade-offs, program options, etc.**

*Los Alamos - Brookhaven*

**APT**

# ERAB VISIT TO LOS ALAMOS

## 27 October 1989

---

<b>TIME</b>	<b>TOPIC</b>	<b>LEAD</b>
<b>8:30- 8:45</b>	<b>Ross 8 met, visitors badged, and transported to TA-53</b>	<b>Protocol</b>
<b>8:45- 9:45</b>	<b>Briefing/Tour of Los Alamos Meson Physics Facility</b>	<b>MP-DO Staff</b>
<b>9:45- 9:55</b>	<b>Travel to MPF-18 and 19</b>	<b>Protocol</b>
<b>9:55-10:30</b>	<b>Briefing/Tour of Accelerator Test Stand, etc.</b>	<b>AT-DO Staff</b>
<b>10:30-10:40</b>	<b>Walk to MPF-365</b>	<b>AT-DO Staff</b>
<b>10:40-11:20</b>	<b>Tour of Ground Test Accelerator, MPF-365</b>	<b>AT-DO Staff</b>
<b>11:20-12:30</b>	<b>Working lunch (ERAB questions &amp; answers)</b>	<b>APT Staff/J. Jackson</b>
<b>12:30</b>	<b>Depart for Ross 13</b>	<b>Protocol</b>

*Los Alamos - Brookhaven*



**APT**

**SUPPORTING  
MATERIAL  
FOR  
ACCELERATOR  
DESIGN**

*Los Alamos - Brookhaven*

**APT**

**APT  
INJECTOR**

*Los Alamos - Brookhaven*

## Ion Source Scaling

One of the most important figures of merit for an ion source is the "brightness" that indicates the maximum current that can be generated within a specified emittance or, conversely, the minimum emittance for a given current. (Emittance is a measure of the disorder in a beam and greatly influences the design of downstream accelerator components). The brightness is essentially the ratio between the current,  $I$ , and the square of the normalized emittance,  $\epsilon_n$ . For a well-designed, ion-optical system, this is equivalent to the ratio of the current density,  $j$ , divided by the temperature,  $T_i$ , of the ions in the beam.

The Child-Langmuir Law relates the current density to the extraction voltage,  $V$ , and the extraction gap spacing,  $d$ . The maximum voltage that can be maintained across a gap is limited by sparking or breakdown. Thus, the maximum current density that can be extracted from an ion source drops rapidly as the voltage is increased. Similarly, the maximum achievable brightness decreases rapidly as the extraction voltage is increased.

This scaling points toward a low-extraction voltage for the APT ion source and requires a plasma source that will provide high-current density with low-ion temperature.

## Ion Source Scaling Relationships

Brightness  $B_n = \frac{2I}{\pi^2 \epsilon_n^2} = \left( \frac{j}{kT_i} \right) \left( \frac{8mc^2}{\pi} \right)$

Child - Langmuir  $j \propto \frac{V^{3/2}}{d^2}$  |  $\rightarrow \rightarrow \rightarrow j \propto \frac{1}{V^{5/2}}$

Breakdown  $V \propto d^{1/2}$  |

$$B_n \propto \frac{1}{(kT_i)V^{5/2}}$$

$\rightarrow \rightarrow$  Low extraction voltage

$\rightarrow \rightarrow$  High current density

$\rightarrow \rightarrow$  Low effective ion temperature

## The DuoPIGatron Ion Source

This schematic shows the major components and the electrical connections of the dc duoPIGatron ion source developed at the Chalk River Nuclear Laboratories. The plasma generator operates as a hot-cathode, magnetically confined, reflex-arc discharge and provides a very high-density, but quiescent, plasma from which to extract an ion beam. The extraction column illustrated here uses seven 5-mm diameter apertures to provide up to 300 mA of protons at energies from 35 - 50 keV. In operation on a commercial ion-beam implanter, it provides 150 mA of atomic oxygen at 35 keV. The extensive water cooling and low-power density on the electrodes allows full dc operation with long component lifetime. This source is currently in use on the RFQ1 injector at Chalk River.

# APT

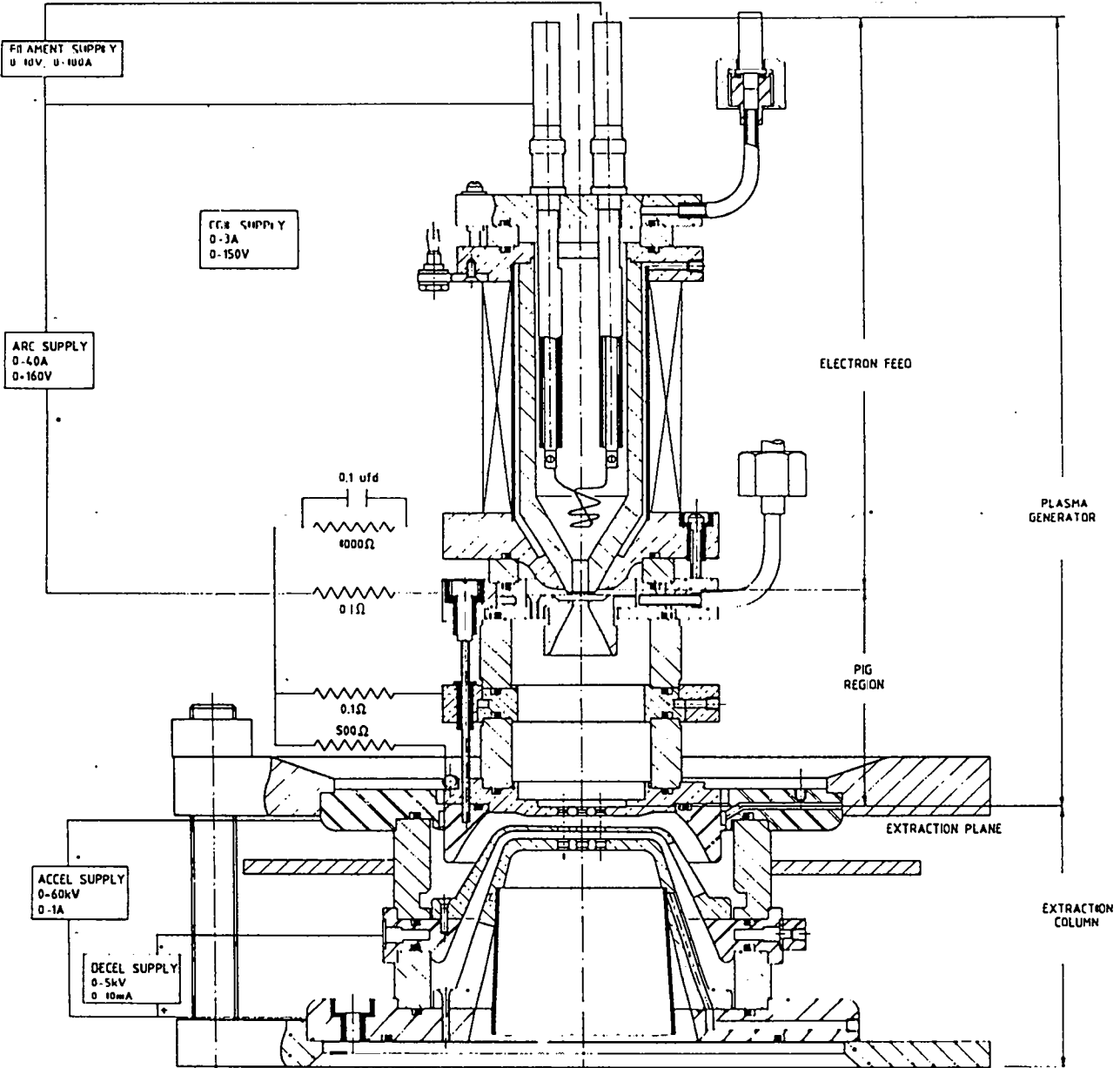

Los Alamos - Brookhaven

## The DuoPIGatron Ion Source

This is a photograph of the dc duoPIGatron source shown schematically on the previous page. A version of this source with a cleaner design, improved cooling, and easier assembly has been designed and fabricated at Los Alamos.

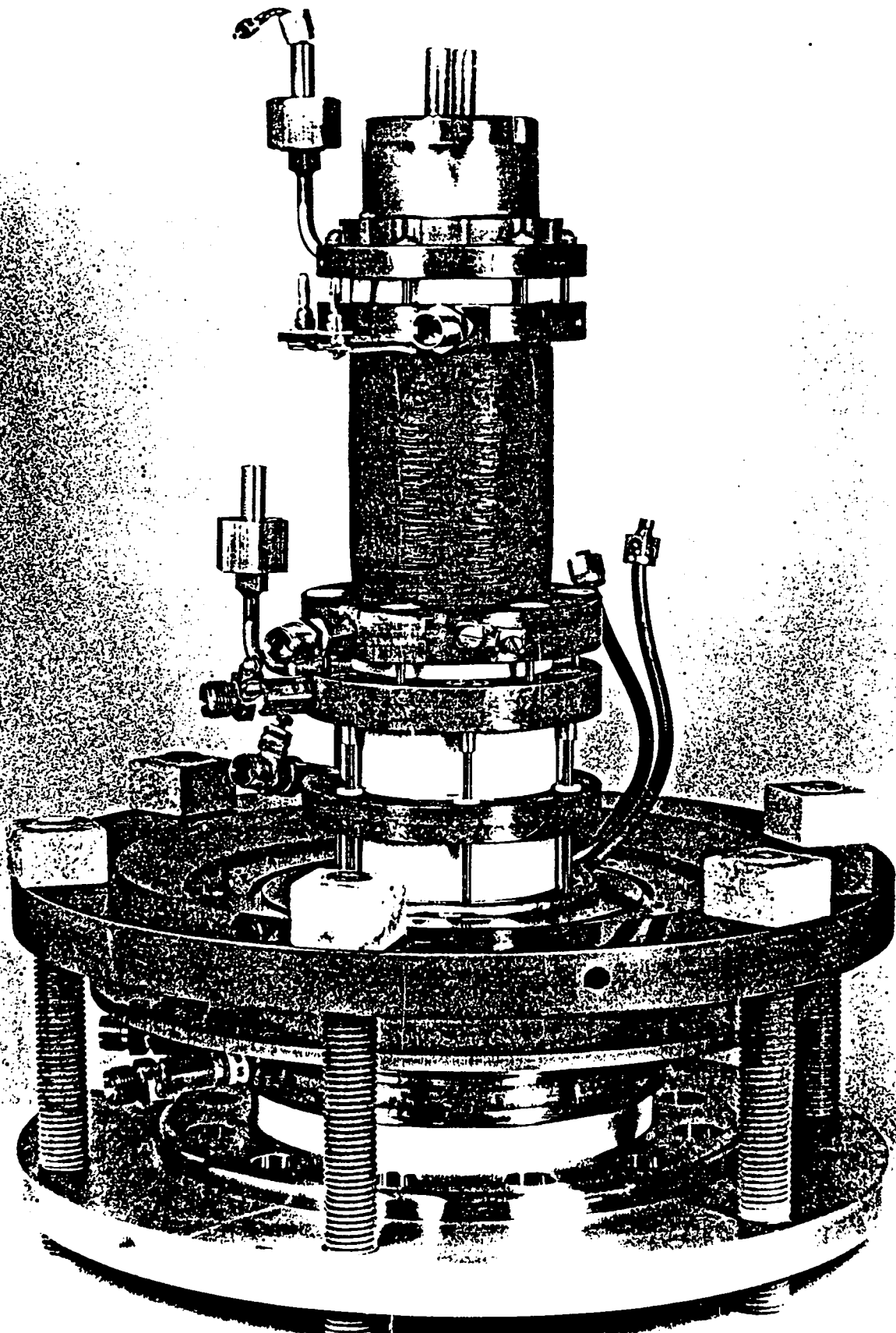



## The RTNS-II Injectors

The facing illustration shows the high-voltage dome and power-supply output circuitry of one of the two RTNS-II injectors. These high-current dc ion beam sources operated up to 20 shifts per week, providing 130-mA, 350-keV dc deuteron beams with good reliability. The beams were stopped on tritiated targets to provide intense neutron fluxes for materials testing in the U.S. fusion energy program. An ion source located inside the dome provided a 35-keV beam of deuterium ions that was conditioned for injection into an acceleration column operating at 300 - 350 kV. The extensive experience with these injectors provides a good database for design of the APT injectors.

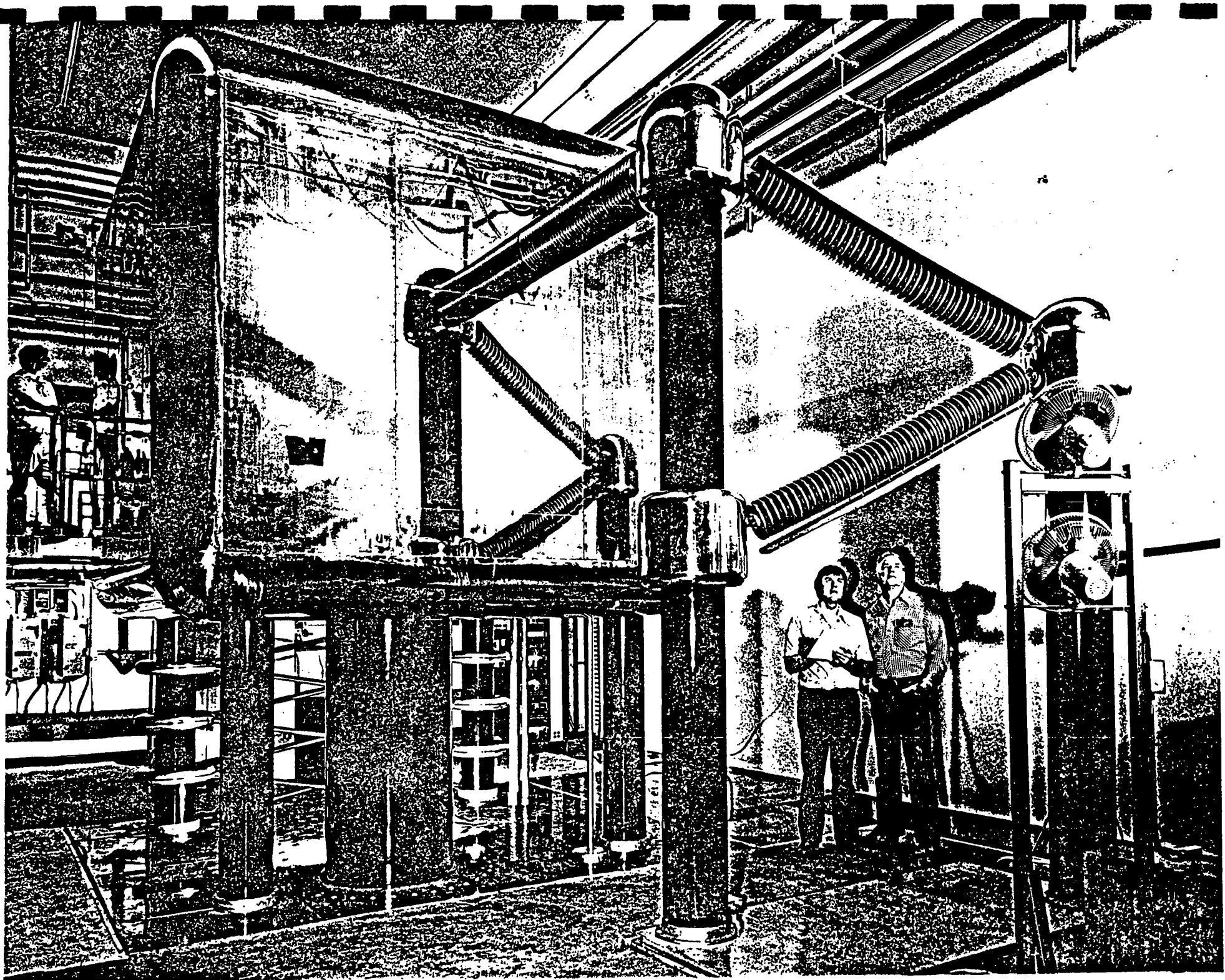

## APT Injector Layout

Layout of the main components of one of the APT injectors is shown on the facing page. The ion source generates a plasma using an electric discharge in the hydrogen gas fed to the source. Atomic and molecular hydrogen ions are extracted from this plasma and formed into a beam with an energy of 35 keV. The magnet is used to separate the molecular ions from the atomic ions. The molecular ions are dumped on the beam stop, and the atomic ions (or protons) continue toward the final acceleration column and the RFQ. The two solenoid magnets are used to control the beam size and convergence angle at the entrance to the RFQ. All components shown within the large rectangular outline are located on a deck that is at a potential of 65 kV with respect to ground. This potential, which exists across the column on the right-hand side of the illustration, accelerates the proton beam to its final energy of 100 keV. The column also helps to shape the beam for injection into the RFQ.

Large turbomolecular pumps are used to maintain the necessary vacuum in the beamline. These pumps are located under the two spool pieces, the first solenoid, and the beam stop. Other injector components include power supplies, control and instrumentation electronics, and a gas-handling system.

Design of this injector is based on experience with the RFQ1 injector at the Chalk River Nuclear Laboratories and the RTNS-II injectors at Livermore.

# APT

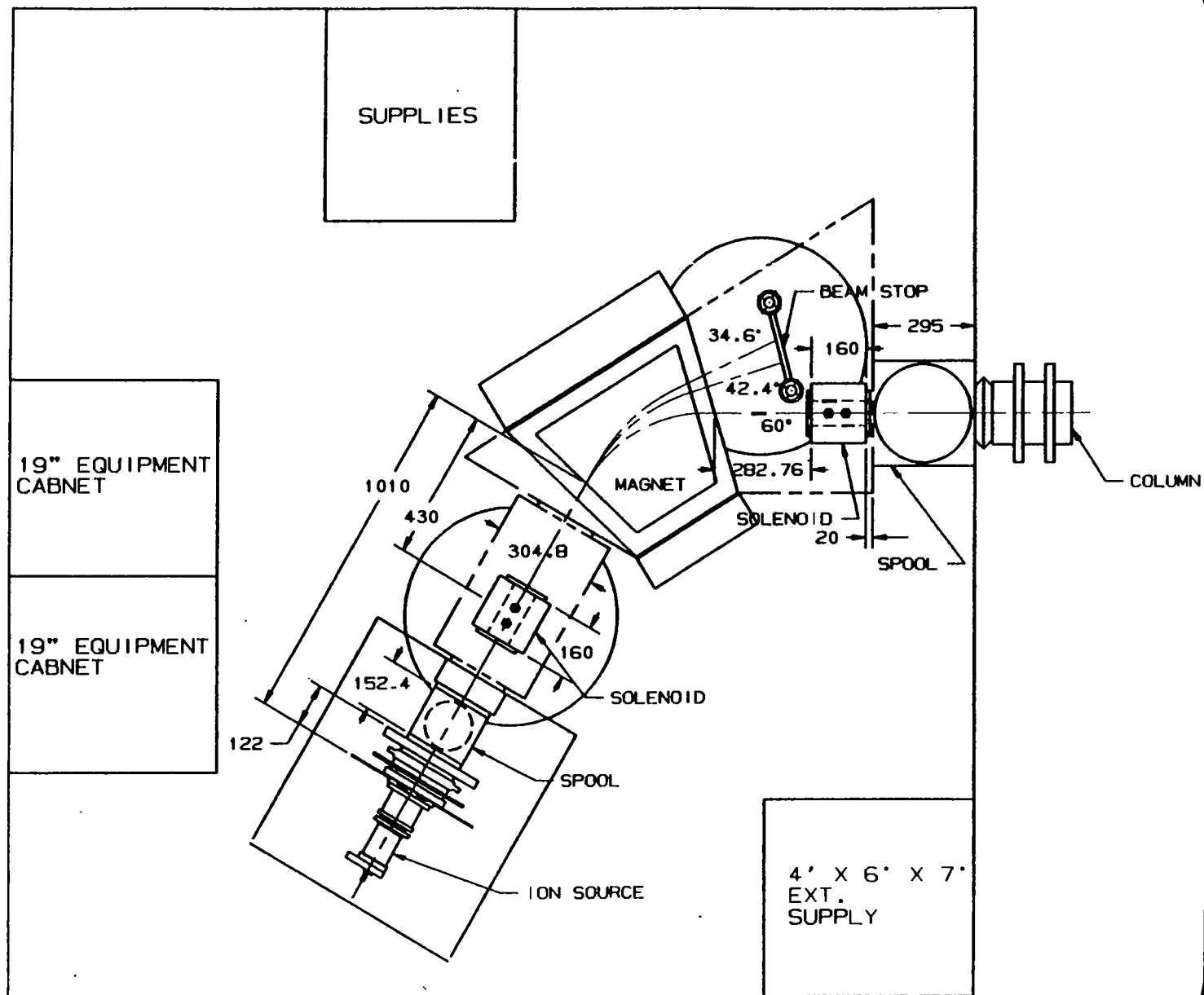

Los Alamos - Brookhaven

**APT**

**APT  
PHYSICS DESIGN**

*Los Alamos - Brookhaven*

## LINAC PHYSICS DESIGN FOR APT

Our main objective in the linac design is to provide high transmission with low beam losses. To reduce beam losses it is important to control the growth of emittance (phase-space volume occupied by the beam) and the associated beam halo. Although the causes of beam halo formation in phase-space are not completely understood, much has been learned from our numerical simulation studies. In these studies it is observed that nonlinear space-charge forces act to produce halo. Nonlinear focusing forces create filamentation in phase space and increase the rms normalized emittance, but are not observed in the simulation studies to produce halo. The halo appears to be the result of the nonlinear processes within the beam caused by the time-dependent collective space-charge forces. Particles that populate the halo have acquired larger center of mass energies.

Transitions in the accelerator, where parameters change, appear to increase the amount of halo in phase-space. Transitions such as changes in the strength of the external focusing force, changes in periodicity of the focusing lattice, introduction of deflecting elements, or changes in rf frequency, cause a change in the external focusing, and as a result the beam must adapt. Given a sufficient number of beam plasma periods after such a transition is introduced, the beam has evolved to a quasi-stationary state. During this evolution process beam halo appears to be produced. The rms emittance will increase if the focusing strength decreases: then space-charge field energy is converted to thermal energy as the beam distribution evolves toward a more uniform profile in real space. An increase in focusing strength likewise results in an rms emittance decrease and a more Gaussian-like profile in real space. In both cases it appears that halo can be produced. The time scale for halo production is not yet well established but appears to be in the range of a few to a few tens of beam plasma periods. This time scale may have relevance in the design of emittance-filter systems.

The evidence obtained from simulations suggests that strong focusing is an effective strategy for minimizing halo production. This is already known to be the most effective approach for minimizing rms emittance growth, even though it does increase the beam density. It does appear that accelerator transitions should be minimized, and introduced only when necessary; ion source extraction, bunching and (in some cases) funneling, are examples of some that are necessary. If these transitions are kept at the low energy end of the accelerator, the activation effects of the associated local beam losses are minimized, and collimator systems that act as emittance filters to remove the halo will be more effective and easier to implement. Good beam matching across these transitions is very important to minimize the disruption to the beam.

With regard to rms emittance, we believe this is a quantity whose growth should be controlled. Not only is rms-emittance growth often correlated with halo production, but the rms emittance affects the overall spatial size of a given beam distribution; the larger the rms emittance, the larger the beam size and the greater the extension in real space of the halo that already exists. Therefore, an important figure of merit in the design of the high energy sections of the accelerator is the ratio of effective aperture (either radial or longitudinal) to the rms beam size.

Using a uniform 3-D ellipsoid model for the beam bunch in a linac, we have been able to derive analytic expressions for the ratio of aperture to rms beam size. In the transverse planes the results are

$$\left(\frac{a_o}{a}\right)^2 = \frac{\gamma \omega_o a_o^2}{\epsilon_n c} \frac{1}{U_t + \sqrt{1 + U_t^2}} \quad (1)$$

where  $a_o$  is the aperture radius,  $a$  is the rms beam size,  $\gamma$  is the relativistic mass factor,  $\omega_o$  is the angular frequency of zero-current betatron oscillations,  $\epsilon_n$  is the rms normalized emittance, and  $c$  is the speed of light. The quantity  $U_t$  is a transverse

space-charge parameter given by

$$U_t = \frac{1}{20\sqrt{5} \beta \gamma^2 \phi} \left( \frac{c}{\omega_o \epsilon_n} \right) \left( \frac{q Z_o I}{m c^2} \right) \quad (2)$$

where  $\phi$  is the rms phase length of the bunch,  $q$ , and  $m c^2$  are the particle charge and rest energy,  $Z_o$  is the impedance of free space (377  $\Omega$ ) and  $I$  is the average beam current over an rf period. In the thin lens approximation for a focusing - defocusing (FD) quadrupole lattice, the betatron frequency can be expressed as

$$\omega_o = \frac{q B_o l}{2\gamma m a_o} \quad (3)$$

where  $B_o$  is the quadrupole pole-tip magnetic field, and  $l$  is the quadrupole effective length. The ratio in Eq. 1 can be maximized by appropriate choice of the lattice parameters.

A similar expression can be derived for the corresponding longitudinal ratio

$$\left( \frac{\phi_o}{\phi} \right)^2 = \left( \frac{\beta \lambda \phi_s}{2\pi} \right)^2 \left( \frac{\gamma \omega_{to}}{\epsilon_n c} \right) \frac{1}{U_t + \sqrt{1 + U_t^2}} \quad (4)$$



where  $\phi_s$  is the synchronous phase,  $\lambda$  is the rf wavelength,  $\omega_{\ell 0}$  is the zero-current longitudinal oscillation frequency, and  $U_l$  is a longitudinal space-charge parameter given by

$$U_l = \frac{1}{40\sqrt{5}\pi} \left( \frac{q Z_o I}{\gamma^2 m c^2} \right) \left( \frac{\lambda c}{\epsilon_n \omega_{\ell 0} a_o} \right) \left( \frac{a_o}{a} \right) \quad (5)$$

The quantity  $\omega_{\ell 0}$  depends on the effective axial accelerating electric field  $E_o T$  and is given by

$$\omega_{\ell 0}^2 = \frac{2\pi q E_o T (\sin \phi_s)}{\gamma^3 m \beta \lambda} \quad (6)$$

For control of unwanted beam spill the designer must keep the ratio  $a_0/a$  large. If it is also desirable to control space-charge induced emittance growth, the ratio  $a/\lambda_D$  should be kept small, where  $\lambda_D$  is the beam-Debye length. For a spherical bunch this ratio can be expressed as

$$\left( \frac{a}{\lambda_D} \right)^2 = \left( \frac{3qI}{20\sqrt{5}\pi\epsilon_o mc^3} \right) \frac{a\lambda}{\epsilon_n^2} \quad (7)$$

For a given current  $I$  and emittance  $\epsilon_n$ , the ratio is minimized by minimizing the product of beam size times rf wavelength, which implies strong focusing and high frequency. The physical explanation for the advantage of high frequency is that the total current,  $I$ , is distributed over more longitudinal buckets. The physical advantage of small beam size is less obvious. It results from the competition between the space-charge force which increases for small beam size (a disadvantage), and the spatial extent over which a given thermal energy input is distributed, which decreases for small beam size (an advantage).

The physics design of the APT linac is based upon the above ideas. The dc injector, Radiofrequency Quadrupole (RFQ) linac, Drift-Tube Linac, and funnel constitute the front end of the accelerator. The primary objective of the front end design is to produce a high quality, low emittance beam that can be injected into the main Coupled-Cavity Linac (CCL) at 20 MeV, and subsequently accelerated as a very compact beam to 1600 MeV with minimal beam loss. The emphasis in the front end design is low emittance growth and low halo production as the beam experiences the major transitions of bunching, and funneling with frequency doubling. Minimizing beam loss in the front end is a secondary objective, as long as the activation consequences are acceptable, and heating consequences are addressed by providing sufficient cooling. The low emittance growth is achieved by providing a high frequency linac to reduce the particles per bunch, and by providing strong transverse focusing with rf-electric quadrupoles (RFQ), magnetic quadrupoles (DTL), and ramped accelerating fields for strong longitudinal focusing in the DTL.

The primary objectives in the CCL are to (1) introduce no major transitions that can lead to further beam halo (2) provide large apertures to minimize beam losses, which, even at relatively low levels, can lead to significant activation levels, and (3) provide sufficient focusing to maintain compact beam dimensions and minimize further emittance growth. An important figure of merit is the ratio of aperture over rms beam size. This quantity can be maximized by choosing a large product of pole-tip magnetic field times effective length for the quadrupoles, using a high density of quadrupole focusing lenses, and providing the largest practical

apertures. A high density of focusing elements leads to short accelerator tanks (2 to 10 cells for APT, rather than 30 to 60 as was done for LAMPF). The CCL is divided into seven different sections so that larger apertures can be used as the particle velocity increases, and so that the ratio of aperture over rms size can be maximized for each velocity region. Furthermore, as the velocity increases it becomes possible to increase the number of accelerating cells per tank, thereby reducing the number of components. An accompanying table of CCL parameters is provided.

## Nomenclature

Cell	TM <sub>010</sub> -mode resonant structure with one accelerating gap
Cavity	Sequence of adjacent (coupled) cells spaced at interval $\beta\lambda/2$
Lattice unit	Cavity + quadrupole + stripline probe
Section	Group of lattice units with same number of cells per lattice unit
RF module	Subgroup of lattice units fed by a single RF tube
$a_0$	Aperture radius of accelerating structure and quadrupoles (cm)
$a$	RMS radius of beam (cm)
$l_Q$ -min	Quadrupole length at lowest beta in section (cm)
$l_P$	Stripline-probe length (cm)
$l_C$	Cavity length (cm)
$l_U$	Lattice-unit length (cm)
$ZT^2$	Cavity shunt impedance per unit length (M $\Omega$ /m) (Reduced 20% from code value, for coupling slots, etc)
$E_0T$	Accelerating gradient averaged over cavity length
$\Phi_s$	Cavity RF phase angle (degrees)
$P_b$	RF power delivered to the beam by each cavity (MW/cavity)
$P_c$	RF power dissipated in copper by each cavity (MW/cavity)
$P_t$	RF power delivered to each cavity ( $P_b + P_c$ ) (MW/cavity)
No. Lattice Units	Number of lattice units in each section
$L_S$	Length of each section (m)
$P_B$	Power delivered to beam by each section (MW/m)
$P_C$	RF power dissipated in copper by each section (MW/m) (1.2 x calculated value)
$P_T$	Total RF power delivered to each section (MW/m)
% Beam Loading	$P_B/P_T$

# APT Coupled-Cavity Linac Parameters (700 MHz)

Revised 10/23/89

$(E_0T)_{\text{lattice-avg}} = 1.0 \text{ MV/m}$     $\Sigma P_T = 509.8 \text{ MW}$     $\Sigma P_B = 395.0 \text{ MW}$     $\Sigma P_C = 114.8 \text{ MW}$     $\Sigma L_S = 2063.4 \text{ m}$    1451 Lattice Units   10275 Cells

	1	2	3	4	5	6	7
W (MeV)	20	40	80	160	320	640	1000
$\beta$	0.203	0.283	0.389	0.520	0.666	0.804	0.875
$\beta\lambda$ (cm)	8.7	12.1	16.7	22.3	28.5	34.4	37.5
							1600
							0.929
							39.8

Structure	2-cell	3-cell	4-cell	6-cell	8-cell	10-cell	10-cell
Mode	$\pi/2\text{-TM}_{010}$	$\pi/2\text{-TM}_{010}$	$\pi/2\text{-TM}_{010}$	$\pi/2\text{-TM}_{010}$	$\pi/2\text{-TM}_{010}$	$\pi/2\text{-TM}_{010}$	$\pi/2\text{-TM}_{010}$
$a_0$ (cm)	1.4	1.9	3.0	3.5	3.5	3.5	3.5
$a_0/a$	9	12	19	22	22	22	22
$I_{Q\text{-min}}$ (cm)	6.5	7.1	7.5	7.5	7.5	7.5	10.0
$I_P$ (cm)	2.0	2.7	3.7	4.8	6.0	6.8	7.3
$I_C$ (cm)	8.7-12.1	18.2-25.1	33.4-44.6	66.9-85.5	114.0-137.6	172.0-187.5	187.5-199.0
( $\beta\lambda$ units)	$1.0\beta\lambda$	$1.5\beta\lambda$	$2.0\beta\lambda$	$3.0\beta\lambda$	$4.0\beta\lambda$	$5.0\beta\lambda$	$5.0\beta\lambda$
$I_U$ (cm)	21.7-30.3	30.3-41.8	50.1-66.9	89.2-114.0	142.5-172.0	206.4-225.0	225.0-238.0
( $\beta\lambda$ units)	$2.5\beta\lambda$	$2.5\beta\lambda$	$3.0\beta\lambda$	$4.0\beta\lambda$	$5.0\beta\lambda$	$6.0\beta\lambda$	$6.0\beta\lambda$
$ZT^2$ (M $\Omega$ /m)	12.4	13.4	17.7	20.9	24.3	25.2	25.4
Cavity $E_0T$ (MV/m)	2.50	1.67	1.5	1.33	1.25	1.20	1.20
$\Phi_s$ (degrees)	-40	-40	-40	-40	-40	-40	-40
$P_b$ (MW/cavity)	0.050	0.069	0.112	0.194	0.301	0.413	0.444
$P_c$ (MW/cavity)	0.052	0.045	0.0497	0.0644	0.0810	0.1028	0.1094
$P_t$ (MW/cavity)	0.102	0.114	0.162	0.258	0.382	0.516	0.553
No. Lattice units	100	145	179	206	266	218	338
$L_S$ (m)	26.0	52.3	104.7	209.3	417.8	470	783.3
$P_B$ (MW)	5.0	10.0	20.0	40.0	80.0	90.0	150.0
$P_C$ (MW)	5.2	6.5	8.9	13.3	21.5	22.4	37.0
$P_T$ (MW)	10.2	16.5	28.9	53.3	101.5	112.4	187.0
% Beam Loading	49	61	69	75	79	80	80

## Design Philosophy

**Main physics design objective is to provide high beam transmission and low losses.**

- 1. Establish good beam quality at the low energy end to minimize beam emittance and halo.**
  - a) RFQ for low velocity bunching and acceleration.**
  - b) Funneling to provide desired current at lower emittance.**
  - c) Ramped accelerating fields in DTL to control longitudinal emittance.**
  - d) High frequency structures to reduce charge per bunch.**
- 2. At higher energies keep beam away from apertures and longitudinal bucket limits.**
  - a) Large aperture to rms beam size.**
  - b) Large bucket to rms bunch length.**
  - c) Good alignment and beam steering.**
  - d) Good phase control of accelerator structures.**
- 3. Some halo and spill may still occur but activation effects can be limited.**
  - a) Rad-hard electromagnetic quads.**
  - b) Restrict major transitions to lowest velocities.**
  - c) Emittance (halo) filters after major transitions.**

**APT RFQ**

<b>Frequency</b>	<b>350 MHz</b>
<b>Energy</b>	<b>0.1→2.5 MeV</b>
<b>DC Injection current</b>	<b>140 mA</b>
<b>Output current</b>	<b>128 mA</b>
<b>Beam Transmission</b>	<b>0.91</b>
<b>RFQ Length</b>	<b>3.4 m</b>
<b>Copper Power</b>	<b>0.4 MW</b>
<b>Beam Power</b>	<b>0.3 MW</b>
<b>Total Power</b>	<b>0.7 MW</b>

# APT

## APT DTL

<b>Structure</b>	<b>2<math>\beta</math><math>\lambda</math></b>
<b>Lattice</b>	<b>FODO</b>
<b>Frequency</b>	<b>350 MHz</b>
<b>Energy</b>	<b>2.5 - 20 MeV</b>
<b>Current</b>	<b>125 mA</b>
<b>Synchronous Phase</b>	<b>-40°</b>
<b>Accelerating Gradient (E<sub>0</sub>T)</b>	<b>1.1 - 3.1 MV/m</b>
<b>Radial Aperture</b>	<b>0.84 cm</b>
<b>Length</b>	<b>11.3 m</b>
<b>Number of Cells</b>	<b>51</b>
<b>Copper Power</b>	<b>1.3 MW</b>
<b>Beam Power</b>	<b>2.2 MW</b>
<b>Total Power</b>	<b>3.5 MW</b>

*Los Alamos - Brookhaven*



## Funneling

- Two bunched beams of frequency  $f_0$  are combined by transverse deflections to form a single collinear beam with frequency  $2f_0$ .

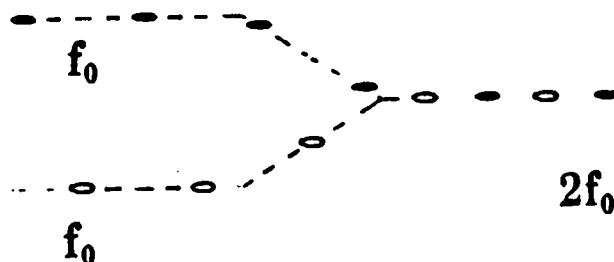

1. With funneling, two ion sources provide the required current at lower emittance.
2. At high enough velocity the linac at frequency  $2f_0$  can accept the funneled beam.
3. Funneling does not increase the charge per bunch. It just interlaces the bunches.
4. Funneling is being developed experimentally by the NPB program.

**Funnel**

<b>Energy</b>	<b>20 MeV</b>
<b>Number Quadrupoles</b>	<b><math>2 \times 5 + 2 = 12</math></b>
<b>Number Dipoles</b>	<b><math>2 \times 2 = 4</math></b>
<b>Number Bunchers</b>	<b><math>2 \times 2 = 4</math></b>
<b>Number rf Deflectors</b>	<b>1</b>
<b>Length</b>	<b>1.5 m</b>
<b>Initial Beam Separation</b>	<b>60.5 cm</b>
<b>Aperture Radius</b>	<b>0.8 cm (0.7 cm in deflector bend plane)</b>
<b>Input Beam Current</b>	<b><math>2 \times 125 \text{ mA}</math></b>
<b>Output Beam Current</b>	<b>250 mA</b>

# APT

## FUNNEL

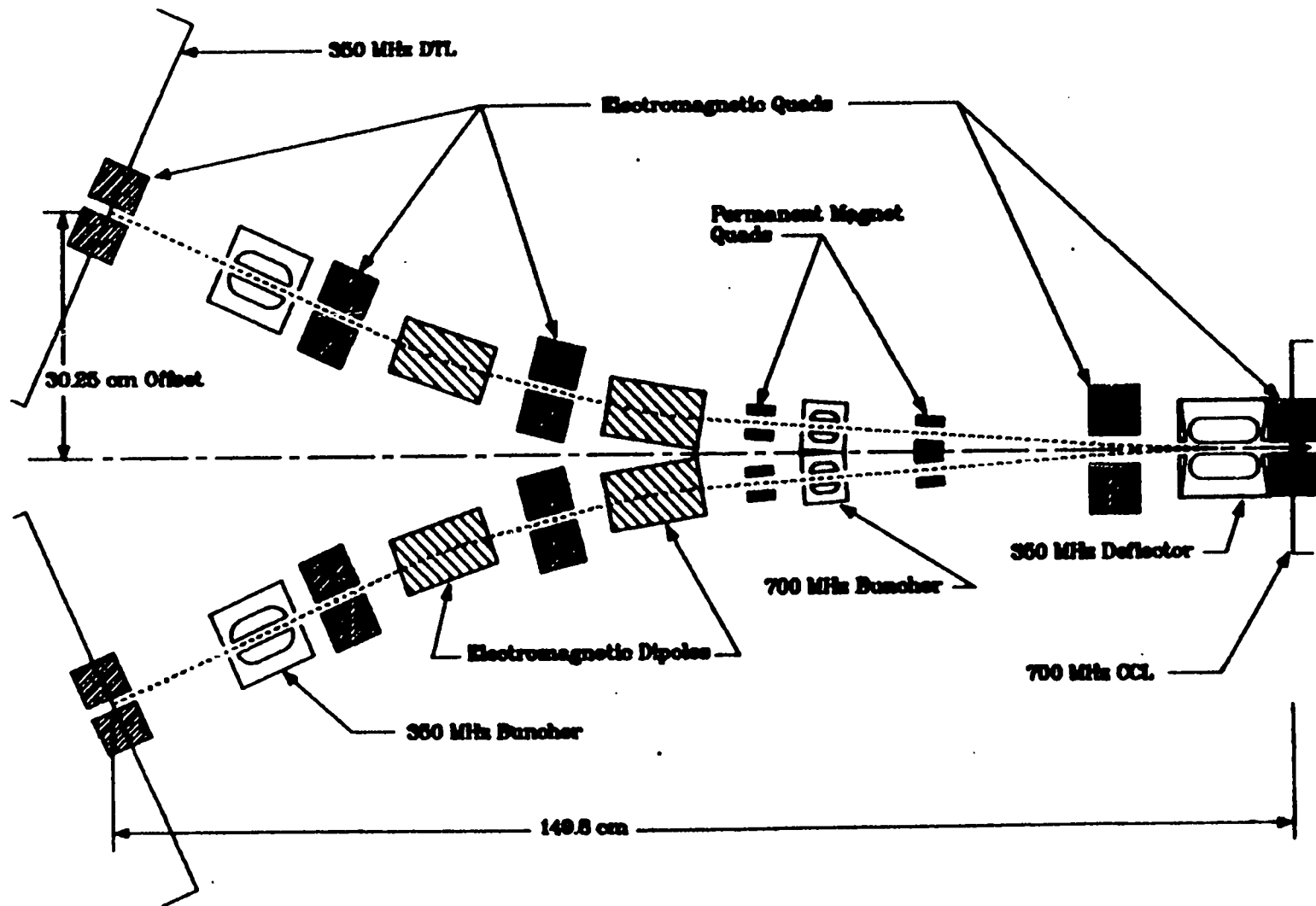

Los Alamos - Brookhaven

## Emittance Filtering

An emittance filter consists of a system of collimators, adjusted to stop all particles outside a given elliptical boundary in phase-space, thereby defining the outer phase-space boundary of the transmitted beam. We believe it is desirable to provide for the possibility of emittance filtering in APT as an additional tool for removing halo; halo that contributes to beam loss and activation of the accelerator. In the APT reference design, the emittance filter is situated between Sections 1 and 2 of the CCL (40 MeV), which is after the major transitions of bunching, and funneling with frequency doubling, that are expected to generate most of the beam halo. Such a filter might be obtained either by placing collimators in the lattice units of Section 2, or by introducing new lattice units that are dedicated to the task.

Initial studies for APT of transverse filtering show that an ideal elliptical filter in phase-space can be approximated by several collimators spaced within one half betatron (transverse oscillation) period. For APT with a betatron phase-advance per focusing period (including space charge) of about  $45^\circ$ , a collimator placed in four consecutive lattice units accomplishes the required filtering. We conclude, however, that it is necessary to provide a second stage (four more lattice units) of filtering to remove particles that are scattered and energy degraded by the first stage of collimators.

The main concern is whether the halo and emittance will regrow after the collimation, which could negate the effectiveness of such a filter. More numerical simulation studies are needed before we are able to answer this question. Another unanswered question is whether emittance filtering is desirable in longitudinal phase space. Longitudinal filtering may involve stages with bending to introduce dispersion, and further collimation to remove off-energy particles. Further studies are required to decide whether the possible benefits of longitudinal filtering are worth the added complexity.

## Emittance Filter

- **Emittance filtering after the major accelerator transitions may not be necessary, but provides additional help in minimizing beam spill.**
- **Ideally the emittance filter will remove all large amplitude particles and define a sharp elliptical phase-space contour.**
- **Our initial studies show that several scrapers per transverse oscillation period can well approximate an ideal transverse elliptical phase-space filter.**
- **A two-stage filter is desirable to remove possible halo generated in the scraper.**

**CCL Advantages**

- 1) Lattice cell length can be optimized to maximize aperture to rms size ratio (equivalent to acceptance over emittance ratio).
  
- 2) Quadrupoles are very accessible for alignment and can be used for beam steering. With a beam position monitor in every lattice cell, it means the beam can be aligned to the precision that its centroid can be measured (1% of aperture).
  
3. Above 20 MeV, power efficiency favors CCL over DTL when electromagnetic quadrupoles must be placed outside the accelerating structures.

## APT CCL

Structure	side coupled
Lattice	FODO, 7 sections
Frequency	700 MHz
Energy	20 - 1600 MeV
Current	250 mA
Number per bunch	$2.2 \times 10^9$
Accelerating Gradient ( $E_0T$ )	1 MV/m (average)
Aperture radius	1.4 - 3.5 cm
Synchronous phase	$-60^\circ$ to $-40^\circ$
Length	2063 m
Number of lattice units	1451
Cells/Tank	2, 3, 4, 6, 8, 10
Copper Power	115 MW
Beam Power	395 MW
Total Power	510 MW

## Nomenclature

Cell	TM <sub>010</sub> -mode resonant structure with one accelerating gap
Cavity	Sequence of adjacent (coupled) cells spaced at interval $\beta\lambda/2$
Lattice unit	Cavity + quadrupole + stripline probe
Section	Group of lattice units with same number of cells per lattice unit
RF module	Subgroup of lattice units fed by a single RF tube
$a_0$	Aperture radius of accelerating structure and quadrupoles (cm)
$a$	RMS radius of beam (cm)
$l_{Q-min}$	Quadrupole length at lowest beta in section (cm)
$l_P$	Stripline-probe length (cm)
$l_C$	Cavity length (cm)
$l_U$	Lattice-unit length (cm)
$ZT^2$	Cavity shunt impedance per unit length (M $\Omega$ /m) (Reduced 20% from code value, for coupling slots, etc)
$E_0T$	Accelerating gradient averaged over cavity length
$\Phi_s$	Cavity RF phase angle (degrees)
$P_b$	RF power delivered to the beam by each cavity (MW/cavity)
$P_c$	RF power dissipated in copper by each cavity (MW/cavity)
$P_t$	RF power delivered to each cavity ( $P_b + P_c$ ) (MW/cavity)
No. Lattice Units	Number of lattice units in each section
$L_S$	Length of each section (m)
$P_B$	Power delivered to beam by each section (MW/m)
$P_C$	RF power dissipated in copper by each section (MW/m) (1.2 x calculated value)
$P_T$	Total RF power delivered to each section (MW/m)
% Beam Loading	$P_B/P_T$



APT Coupled-Cavity Linac Parameters (700 MHz)

Revised 10/23/89

$$(E_0T)_{\text{lattice-avg}} = 1.0 \text{ MV/m} \quad \Sigma P_T = 509.8 \text{ MW} \quad \Sigma P_B = 395.0 \text{ MW} \quad \Sigma P_C = 114.8 \text{ MW} \quad \Sigma L_S = 2063.4 \text{ m} \quad 1451 \text{ Lattice Units} \quad 10275 \text{ Cells}$$

	1	2	3	4	5	6	7	
W (MeV)	20	40	80	160	320	640	1000	1600
$\beta$	0.203	0.283	0.389	0.520	0.666	0.804	0.875	0.929
$\beta\lambda$ (cm)	8.7	12.1	16.7	22.3	28.5	34.4	37.5	39.8
Structure	2-cell	3-cell	4-cell	6-cell	8-cell	10-cell	10-cell	
Mode	$\pi/2$ -TM <sub>010</sub>	$\pi/2$ -TM <sub>010</sub>	$\pi/2$ -TM <sub>010</sub>	$\pi/2$ -TM <sub>010</sub>	$\pi/2$ -TM <sub>010</sub>	$\pi/2$ -TM <sub>010</sub>	$\pi/2$ -TM <sub>010</sub>	
$a_0$ (cm)	1.4	1.9	3.0	3.5	3.5	3.5	3.5	
$a_0/a$	9	12	19	22	22	22	22	
$l_{O\text{-min}}$ (cm)	6.5	7.1	7.5	7.5	7.5	7.5	10.0	
$l_p$ (cm)	2.0	2.7	3.7	4.8	6.0	6.8	7.3	
$l_C$ (cm)	8.7-12.1	18.2-25.1	33.4-44.6	66.9-85.5	114.0-137.6	172.0-187.5	187.5-199.0	
( $\beta\lambda$ units)	$1.0\beta\lambda$	$1.5\beta\lambda$	$2.0\beta\lambda$	$3.0\beta\lambda$	$4.0\beta\lambda$	$5.0\beta\lambda$	$5.0\beta\lambda$	
$l_U$ (cm)	21.7-30.3	30.3-41.8	50.1-66.9	89.2-114.0	142.5-172.0	206.4-225.0	225.0-238.0	
( $\beta\lambda$ units)	$2.5\beta\lambda$	$2.5\beta\lambda$	$3.0\beta\lambda$	$4.0\beta\lambda$	$5.0\beta\lambda$	$6.0\beta\lambda$	$6.0\beta\lambda$	
$ZT^2$ (M $\Omega$ /m)	12.4	13.4	17.7	20.9	24.3	25.2	25.4	
Cavity $E_0T$ (MV/m)	2.50	1.67	1.5	1.33	1.25	1.20	1.20	
$\Phi_s$ (degrees)	-40	-40	-40	-40	-40	-40	-40	
$P_b$ (MW/cavity)	0.050	0.069	0.112	0.194	0.301	0.413	0.444	
$P_c$ (MW/cavity)	0.052	0.045	0.0497	0.0644	0.0810	0.1028	0.1094	
$P_t$ (MW/cavity)	0.102	0.114	0.162	0.258	0.382	0.516	0.553	
No. Lattice units	100	145	179	206	266	218	338	
$L_S$ (m)	26.0	52.3	104.7	209.3	417.8	470	783.3	
$P_B$ (MW)	5.0	10.0	20.0	40.0	80.0	90.0	150.0	
$P_C$ (MW)	5.2	6.5	8.9	13.3	21.5	22.4	37.0	
$P_T$ (MW)	10.2	16.5	28.9	53.3	101.5	112.4	187.0	
% Beam Loading	49	61	69	75	79	80	80	

**APT**

**APT  
NUMERICAL  
SIMULATIONS**

*Los Alamos - Brookhaven*

## NUMERICAL-SIMULATION CALCULATIONS

The numerical simulation codes used have been developed at Los Alamos during the past 20 years, and consist of PARMTEQ for the RFQ, PARMILA for the DTL and funnel, and LINAC for the CCL. These codes track particles through the accelerator and most treat the space-charge forces using a fast 2-D particle-in-cell (PIC) approach. In each time step the particles are allocated to cells of an r-z mesh, space-charge fields are calculated, and are used together with the external forces to advance the particles for the next step. In the funnel, where the average x-and y-plane beam envelopes are not symmetrical, a 3-D space-charge calculation is used.

The simulation studies for APT have been carried out beginning with an initial Gaussian DC beam into the RFQ. (The measured beam from relevant dc injectors is consistent with a Gaussian profile). The input beam is distributed uniformly in the longitudinal direction and is assigned zero initial energy spread (a good approximation for the 10 to 100 eV energy spread of a real beam.) The non-ideal APT beam used differs from the ideal beam by changing the parameters in the matching section before the DTL to produce a large mismatch.

LAMPF simulations have been done in a similar way, except that the input transverse beam (also a Gaussian) into the DTL, is chosen to agree with the experimentally measured ellipse parameters. The longitudinal beam was generated by transporting the beam through the LAMPF low-energy beam transport with values chosen to give realistic input conditions. The initial LAMPF simulations predicted the measured emittance growth to within about 10 percent, but have overestimated beam-spill magnitude in the CCL (1.5% spill is predicted, whereas 0.17% is observed). The locations of the beam losses are correctly predicted.

# APT

## Input Beam Distribution To Linac Simulation 0.1 MeV

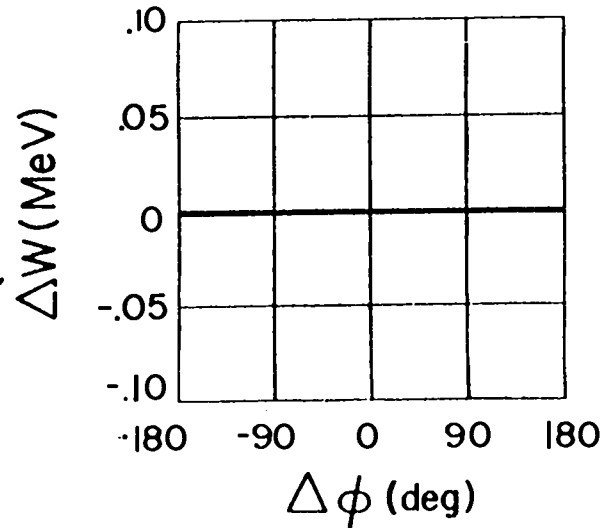
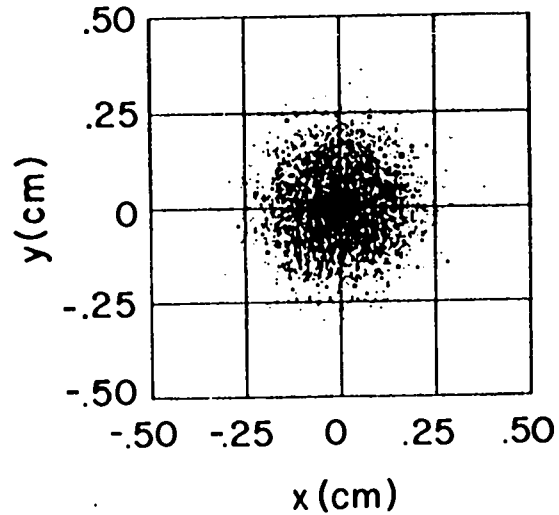
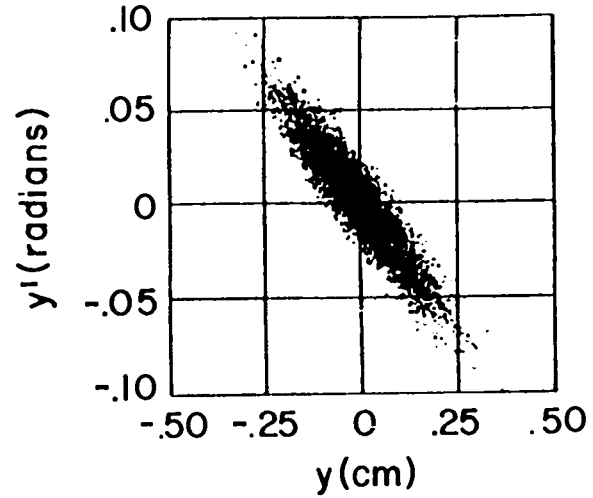
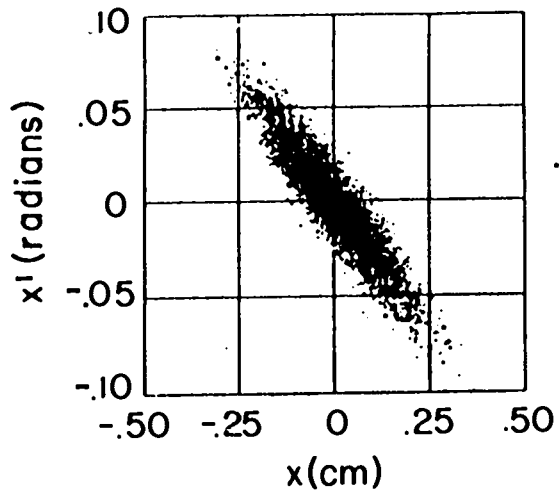

# APT

## RFQ OUTPUT

APT1-78.FREQ= 350 00 MHZ. Q=1 0.WI=0 100.WF= 2 50 AMU= 1 01 I= 140 0MA  
NCELL =249 NBETTER= \*\*\*

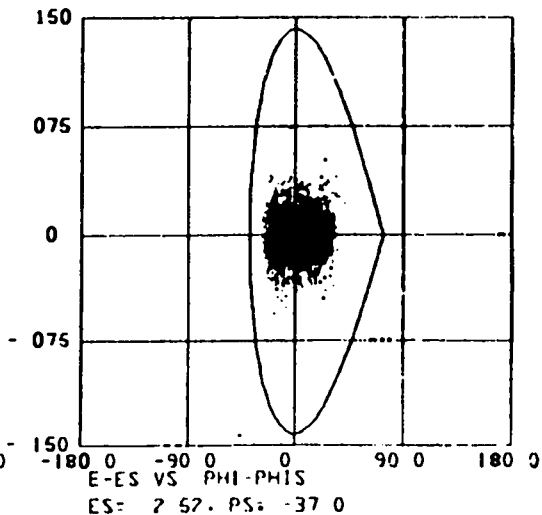
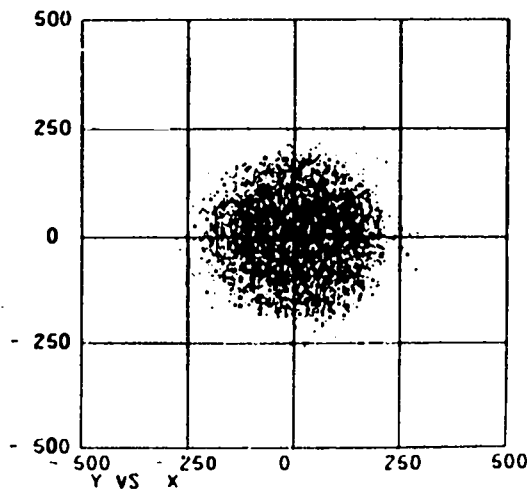
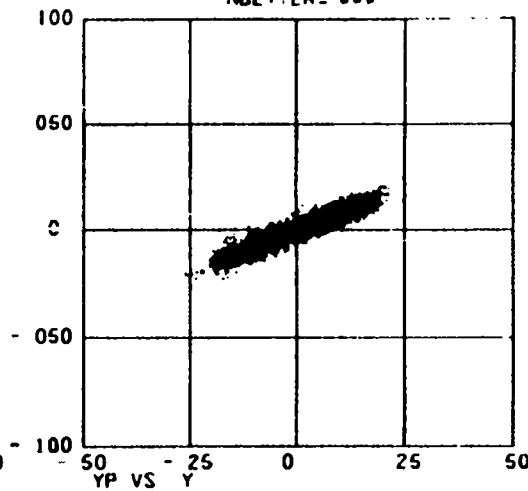
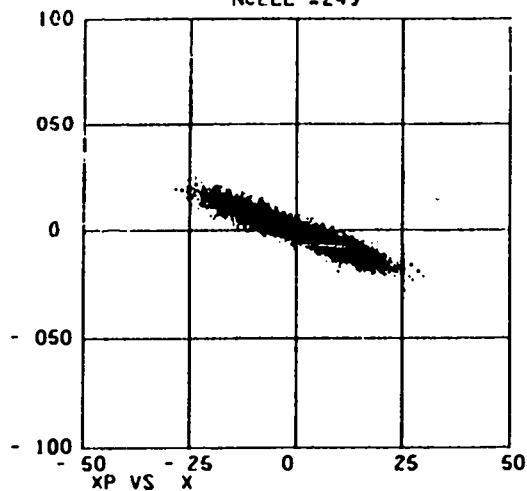

Los Alamos - Brookhaven

# APT

## DTL OUTPUT

APT DTL ZBL FODO Z-DRIVE-ZONEV NFO PARTICLES

89/09/26PIC= 70

NCELL = 61

N0000=6044

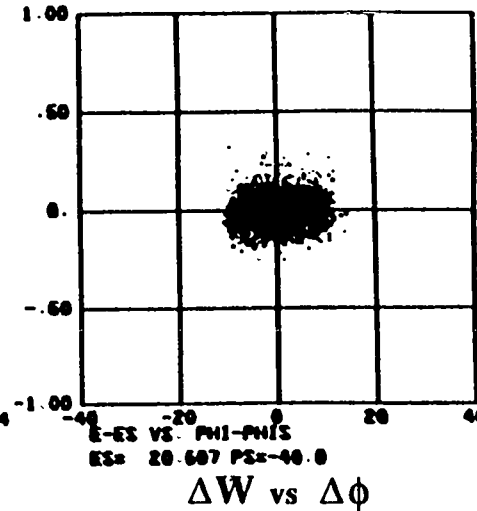
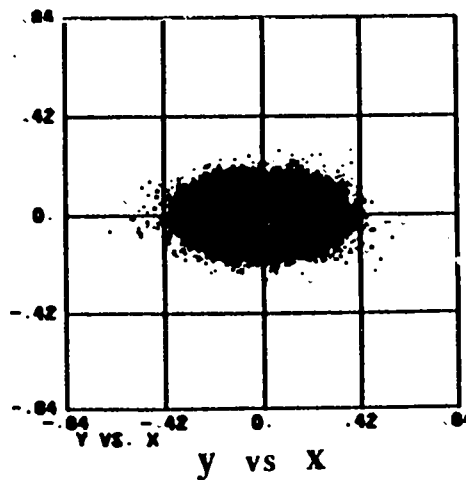
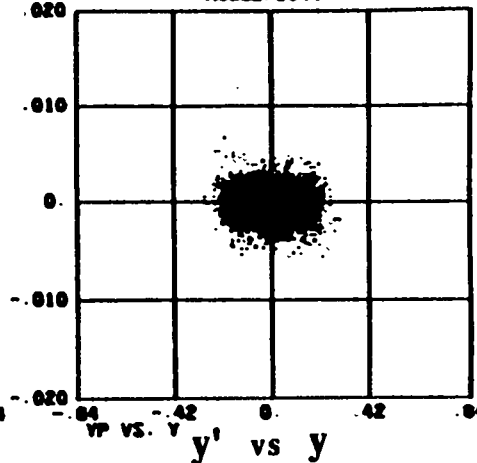
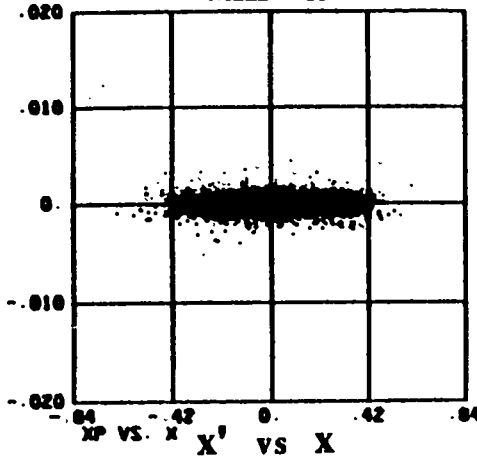

Ideal Beam

Los Alamos - Brookhaven

# APT

## DTL OUTPUT

APT DTL ZBL F000 2 5MEV-20MEV RFQ PARTICLES

89/10/11PIC= 70

NCELL = 51

N0000=6370

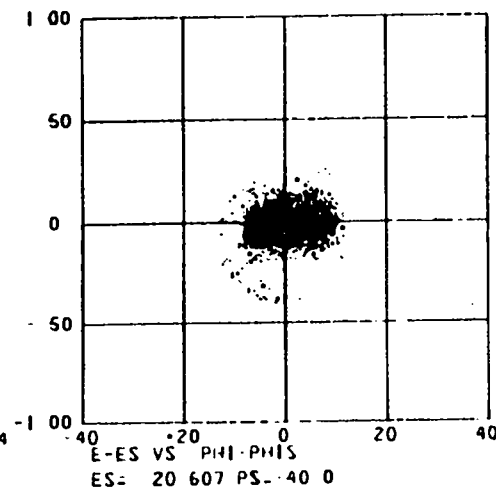
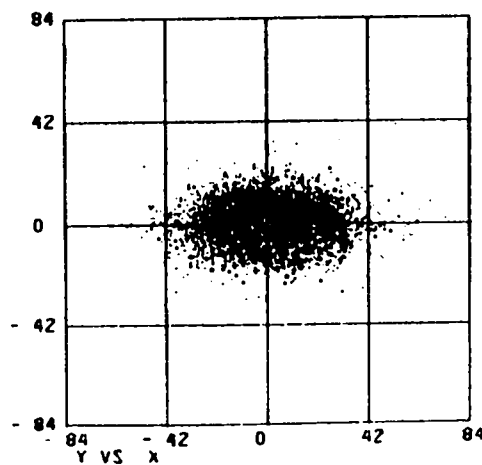
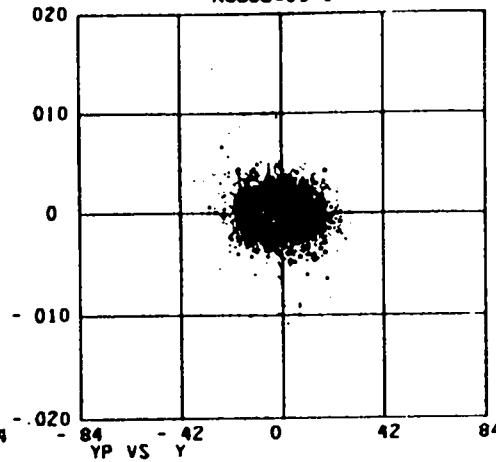
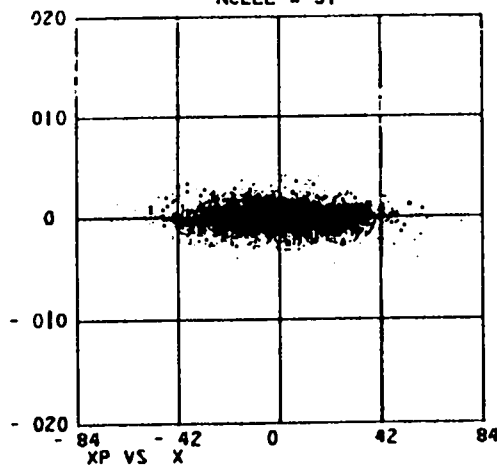

Nonideal Beam

Los Alamos - Brookhaven

# APT

## Output Beam Distribution From Linac Simulation Ideal Beam - 1600 MeV

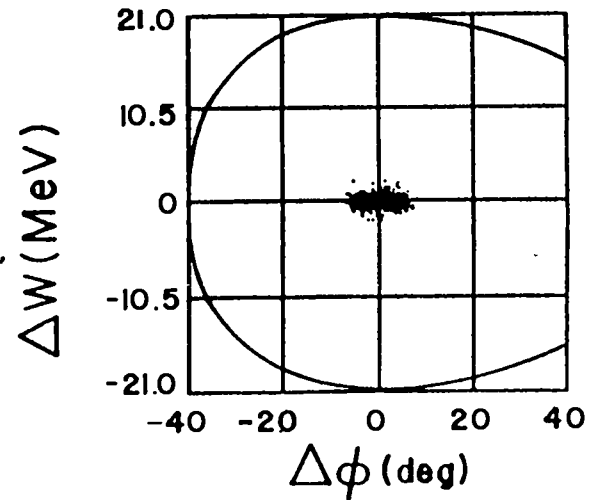
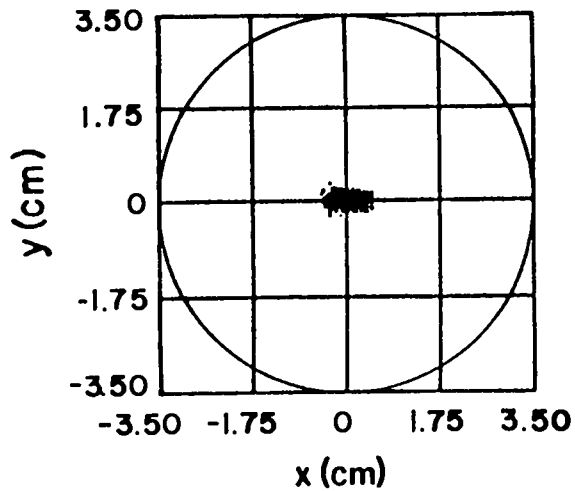
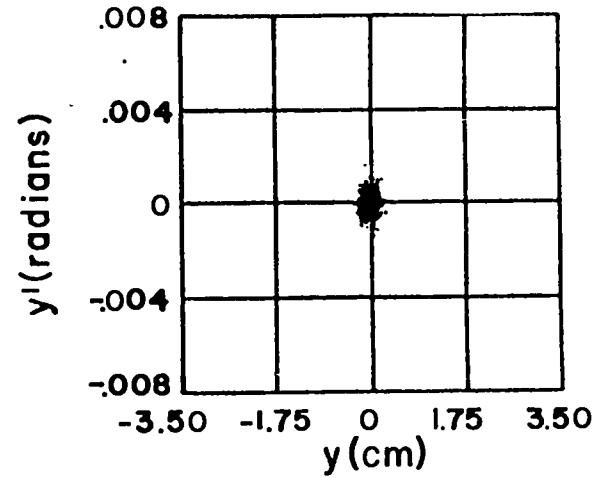
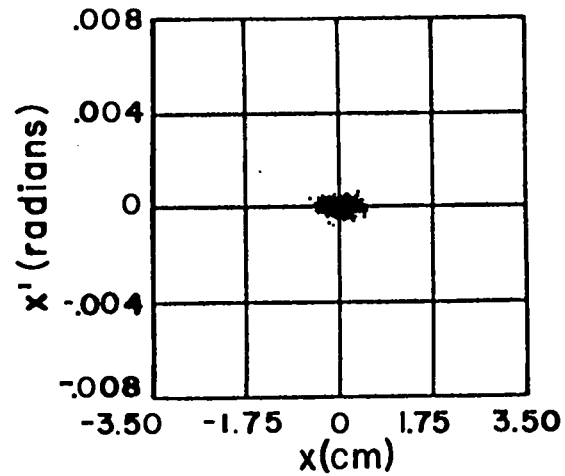



# APT

## Output Beam Distribution From Linac Simulation Nonideal Beam - 1600 MeV

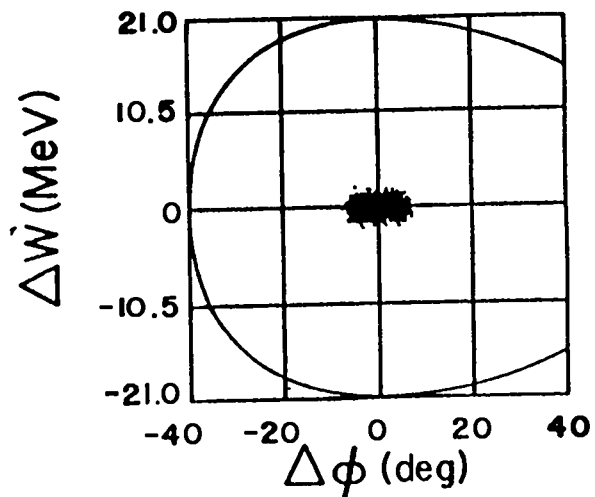
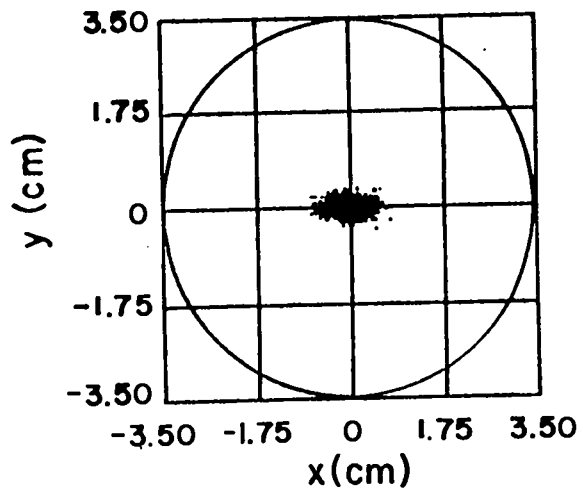
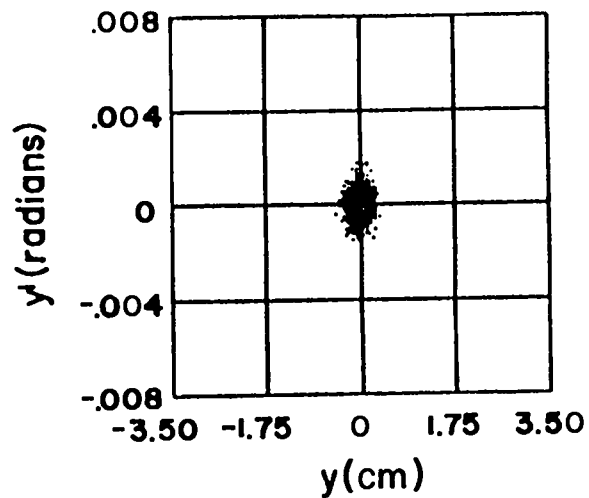
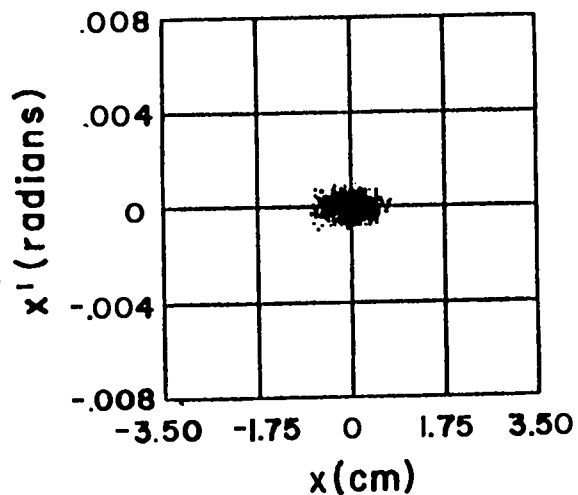

Los Alamos - Brookhaven

## BEAM DYNAMICS FOR NON-IDEAL CONDITIONS AND FAULTS

To represent the effect of beam mismatch in the real accelerator, we have deliberately mismatched the beam in the matching section between the RFQ and DTL, which resulted in an overall transverse emittance growth of a factor 3.4, compared with a growth of 1.5 for the ideal case. An additional longitudinal emittance growth of a factor 1.4 was also produced. We have referred to this beam as the nonideal beam, and have used its properties for initial estimates of the actual APT beam.

More detailed error studies were carried out for the CCL to evaluate the effects associated with random phase and amplitude errors of  $\pm 1^\circ$ , and  $\pm 1\%$ , and random setting errors in tune-up of  $\pm 1^\circ$  and  $\pm 1\%$ . These errors, together with random quadrupole displacement and orientation errors, were also introduced in the DTL. We have concluded that our non-ideal beam may somewhat underestimate the longitudinal-emittance growth and overestimate the transverse-emittance growth. Nevertheless, we think the non-ideal beam represents a good first approximation to account for the errors found in a real-world accelerator.

Initial studies have been made to evaluate the effects of potential fault conditions. We find that if a single quadrupole fails anywhere in the CCL, the entire beam is still transmitted to the end of the linac. If a single rf module (comprising several accelerator tanks) fails, the beam behavior depends on the energy at which the fault occurs. Above an energy of 320 MeV the entire beam is still captured in a longitudinal rf bucket and is accelerated to full energy, but with an increased output energy spread ( $\sim \pm 20$  MeV). If an rf module is lost between 160 MeV and 320 MeV, about half the beam is transmitted and half is not captured in a longitudinal bucket and is eventually lost radially within the accelerator. If an rf module is lost below 160 MeV, none of the beam is captured longitudinally, and all is lost radially. The beam losses from these rf-fault conditions are distributed along about 30 lattice units (a distance of about 30 m) which would result in a relatively low power density deposited on the accelerating structures.

## Summary

- **Our design philosophy is directed towards minimizing unwanted beam spill.**
  - a) **establishing high beam quality at low energies.**
  - b) **maintaining compact, well aligned beam at high energies.**
  - c) **allowing for emittance filtering.**
- **Our initial goal has been to produce a conservative reference design.**
- **Numerical simulation including space-charge has been used to confirm the good beam characteristics of the reference design.**

**APT**

**COMPARISON OF  
SIMULATION  
AND  
MEASUREMENTS  
FOR LINACS**

*Los Alamos - Brookhaven*

## High Current Linac Data Base

A large data base on the performance of high-current linacs, which has been accumulated from accelerator laboratories during the past 20 years, is provided. From this data we draw the following conclusions.

- (1) Numerical simulation codes have established a good record for predicting accelerator performance, especially when as-built machine parameters are used.
- (2) Measured results from ATS (Accelerator Test Stand - at Los Alamos) show improved beam-quality capability from the use of RFQs and higher frequency structures.
- (3) The number of particles per bunch and peak proton current in some existing DTLs have exceeded requirements for APT.
- (4) The output beam-quality parameters specified in the low energy APT linac design (nonideal beam) have already been achieved experimently on ATS.

## Transverse Emittance Growth in High-Current Linacs Comparison of Measurements with Simulation

	LAMPF DTL + CCL	CERN DTL	CERN DTL	ATS-1 <sup>a</sup> RFQ+DTL	ATS-2 <sup>b</sup> RFQ+DTL	APT RFQ+DTL+CCL
Output Energy (MeV)	800	10	50	5	6.7	1600
Peak Current (mA)	17	82	150	75	75	250
Particles per Bunch	$0.53 \times 10^9$	$3.3 \times 10^9$	$4.6 \times 10^9$	$1.1 \times 10^9$	$1.1 \times 10^9$	$2.2 \times 10^9$
Transverse Emittance:						
Growth (Simulation)	8.7 (ideal)	1.2 (ideal)	1.1 (ideal)	2.5 (realistic)	1.6 (realistic)	1.5 (ideal) 3.4 (non-ideal)
Growth (Measured)	7.9	1.9	2.9	$3.5 \pm 0.35$	$1.8 \pm 0.18$	---
Output (Measured)	0.070	0.070	0.14	$0.060 \pm 0.006$	$0.030 \pm 0.003$	---

a. Uniform-field DTL ( $E_0 = 2$  MV/m). Results quoted are from 1989 measurements. Majority of emittance growth is caused by quadrupole-orientation errors in drift tubes.

b. Ramped-field DTL ( $E_0 = 2$  to 4 MV/m).

## Comparison of RFQ Measurements with Simulation

	Proof of Principle <sup>a</sup>	FMIT <sup>c</sup>	ATS <sup>b</sup>	CERN-1 <sup>a</sup>	BEAR <sup>b</sup>
Peak Current (mA)	30	60	75	80	24
Frequency (MHz)	425	80	425	202.56	425
Output Energy (MeV)	0.64	2.0	2.07	0.51	1.0
Transmission:					
Simulation	88%	93% (20 mA)	90%	89%	90%
Measured	80% ± 5%	70% ± 5% (20 mA)	70% ± 5%	80%	40%
Transverse Emittance:					
Simulated Growth	1.3 (ideal)	Project was terminated before reliable measurements were made.	1.2 (ideal), 1.5 (real)	1.4 ± 0.1 (ideal)	1.0 (ideal)
Measured Growth	1.8 ± 0.3		1.5 ± 0.12	1.3	1.2
Measured Output Emittance (π cm-mrad)	0.014 ± 0.002		0.025 ± 0.002	0.044	0.012
Output Longitudinal Emittance (π deg-MeV):					
Simulation	Detailed structure of energy projection versus vane voltage correctly predicted	Not measured	0.16 (realistic)	Not measured	Not measured
Measured			0.076 ± 0.011		

- These RFQs used adjustable solenoids to match input DC beam.
- These RFQs used non-adjustable permanent-magnet quadrupoles to match input DC beam.
- FMIT RFQ used adjustable electromagnetic quadrupoles to match input DC beam. Larger transmission (85%) was obtained at higher vane voltages than design value.

## Low-Energy Linac Beam-Quality Comparison

	BNL(H <sup>+</sup> ) DTL	CERN(H <sup>+</sup> ) DTL	FNAL(H <sup>+</sup> ) DTL	FNAL(H <sup>-</sup> ) DTL	ATS-1(H <sup>-</sup> ) RFQ+DTL	ATS-2(H <sup>-</sup> ) RFQ+DTL	APT(H <sup>+</sup> ) <sup>a</sup> RFQ+DTL
Output Energy (MeV)	10	10	10	10	5	6.7	20
Peak Current (mA)	100	82	78	50	75	75	125
Particles per Bunch	$3.1 \times 10^9$	$3.3 \times 10^9$	$2.4 \times 10^9$	$1.6 \times 10^9$	$1.1 \times 10^9$	$1.1 \times 10^9$	$2.2 \times 10^9$
Measured Transverse Emittance Growth	2.0	1.9	2.0	2.2	$3.5 \pm 0.35$	$1.8 \pm 0.18$	1.3 (ideal) 3.1 (non-ideal)
Measured Output Emittance ( $\pi$ cm-mrad)	0.12	0.070	0.44	0.14	$.060 \pm .006$	$.030 \pm .003$	.026 (ideal) .061 (non-ideal)
Beam-Current/Emittance <sup>b</sup> [A/(cm-mrad)]	0.83	1.2	0.18	0.36	1.25	2.5	4.8 (ideal) 2.0 (non-ideal)
Brightness <sup>b</sup> [A/(cm-mrad) <sup>2</sup> ]	6.9	17	0.40	2.6	21	83	185 (ideal) 34 (non-ideal)

a. Tabulated emittance values are from simulation only.

b. Figure-of-merit for beam quality.



## High-Energy DTL Performance Comparison

	BNL DTL (H <sup>+</sup> )	FNAL DTL (H <sup>+</sup> )	FNAL DTL (H <sup>-</sup> )	LAMPF DTL (H <sup>+</sup> )	CERN DTL (H <sup>+</sup> )
Output Energy (MeV)	200	200	200	100	50
Beam Current (mA)	100	230	50	17	150
Particles per Bunch	$3.1 \times 10^9$	$7.1 \times 10^9$	$1.6 \times 10^9$	$0.53 \times 10^9$	$4.1 \times 10^9$
Measured Transverse Emittance Growth	4.0	4.5	2.2	2.9 <sup>b</sup> 6.0 <sup>c</sup>	2.9
Measured Output Emittance ( $\pi$ cm-mrad)	0.24	0.81	0.14	0.026 <sup>b</sup> 0.053 <sup>c</sup>	0.14
Beam Current/Emittance <sup>a</sup> [A/(cm-mrad)]	0.42	0.28	0.36	0.65 <sup>b</sup> 0.32 <sup>c</sup>	1.1
Brightness <sup>a</sup> [A/(cm-mrad) <sup>2</sup> ]	1.7	0.35	2.6	25 <sup>b</sup> 6.1 <sup>c</sup>	7.7

- a. Figure-of-merit for beam quality.
- b. Slit and collector measurement.
- c. Wire-scanner measurement.

# APT

## Comparison of APT and LAMPF CCL Above 100 MeV

	LAMPF	APT	
Charge Per Bunch	$0.53 \times 10^9$	$2.2 \times 10^9$	
Bunch Frequency (MHz)	201.25	700	
Transverse (Betatron) Frequency (MHz)	29 - 36	80 - 120	
Radial aperture (cm)	1.6 to 1.9	3.0 to 3.5	
Synchronous phase (deg)	-36 to -30	-40	
		(ideal beam)	(nonideal beam)
Maximum rms size (cm)	0.26 to 0.39	0.11 to 0.14	0.16 to 0.18
Aperture/max rms size	4.9 to 6.3	20 to 30	16 to 20
Maximum rms size (deg)	15. to 3.4	7 to 3	7 to 3
Synch phase/max rms size	2.5 to 8.8	6 to 13	6 to 13

Los Alamos - Brookhaven

***APT***

**BEAM LOSS  
AND  
ACCELERATOR  
ACTIVATION**

*Los Alamos - Brookhaven*

# APT

Activation of accelerator components (per unit of beam loss) is roughly proportional to the number of neutrons produced by each proton. The energy dependence of the neutron yield for copper and iron is displayed in the accompanying graph.

Neutron Yield vs  $E_p$  for Copper/Iron

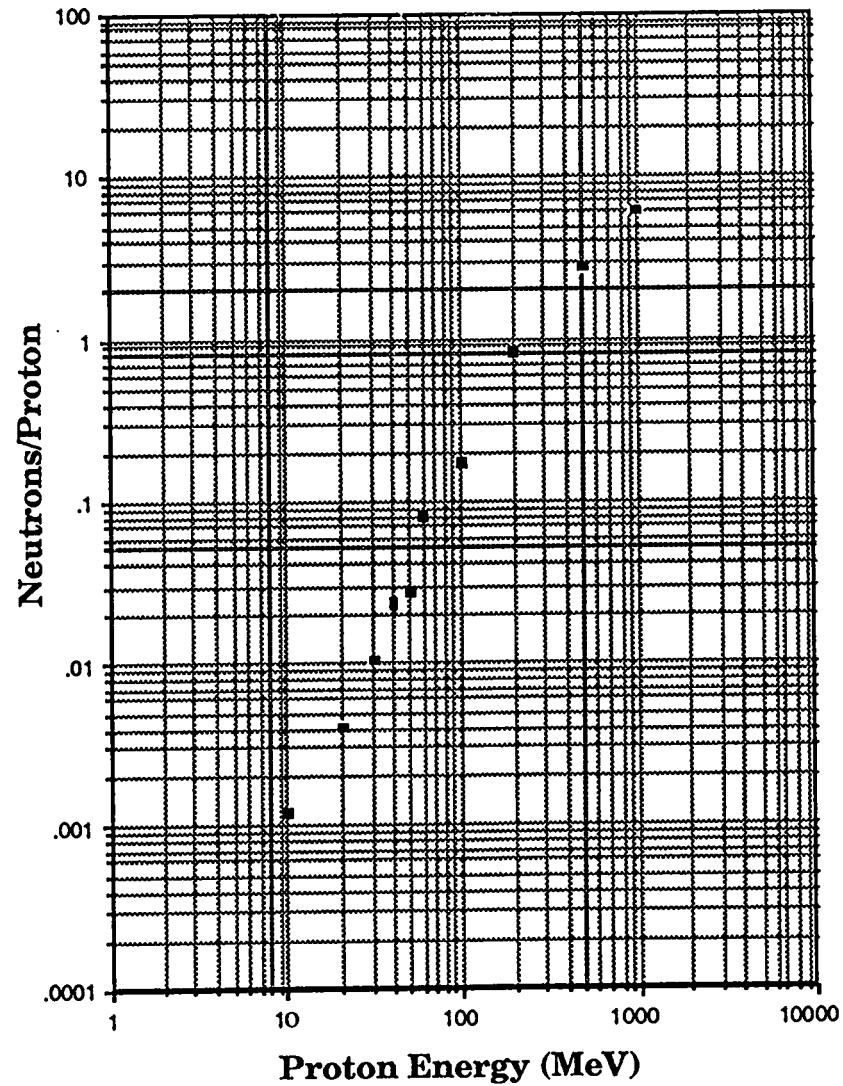

Los Alamos - Brookhaven

## Sensitivity of PM Materials to Integrated Neutron Dose

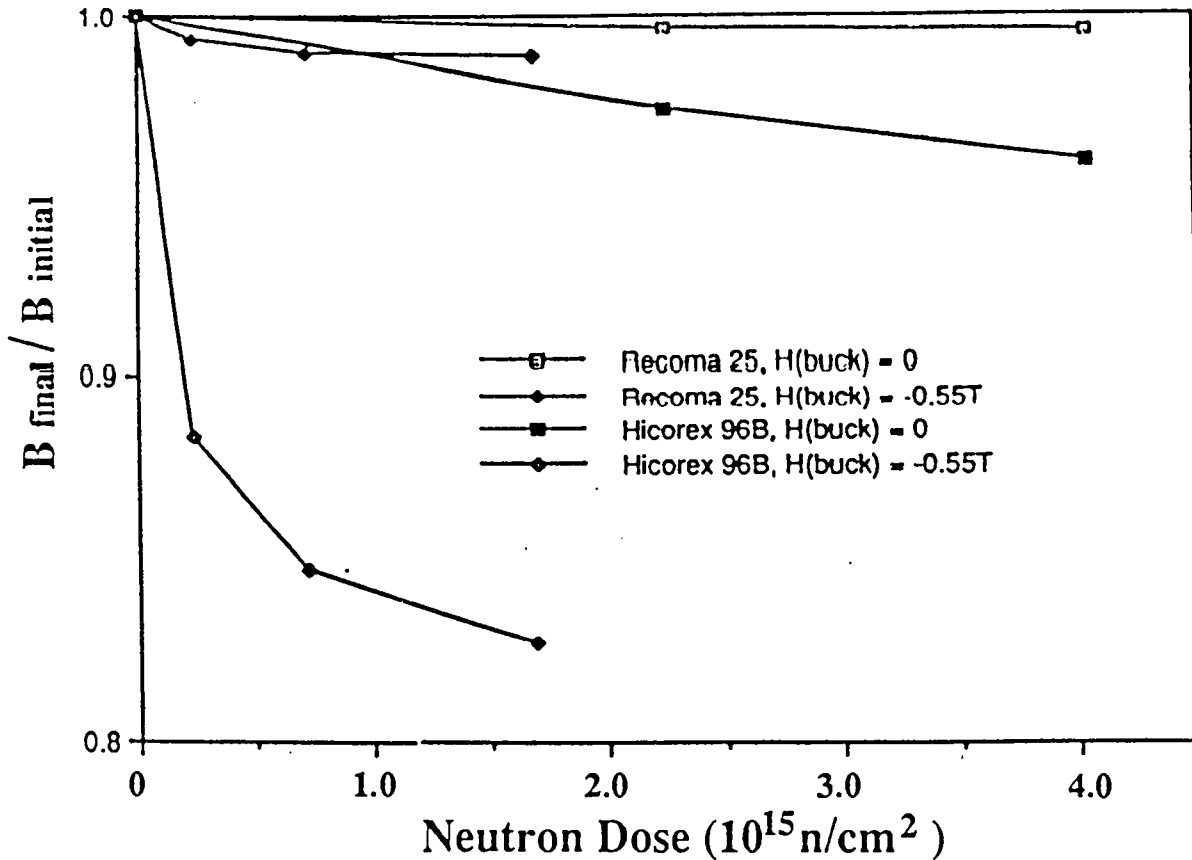

- PM-quadrupole materials have been irradiated to  $4 \times 10^{15} \text{ n/cm}^2$  in the Los Alamos (Omega West) research reactor.
- Significant degradation in magnetic performance was observed.
- LANL materials experts believe that damage may be greater in the energetic neutron spectrum due to beam loss in an accelerator.
- In the APT DTL (20 MeV), fractional beam losses of  $10^{-5}/\text{m}$  would produce integrated neutron doses of  $10^{15}$  to  $10^{16} \text{ n/cm}^2$  within a few months.
- Since it would be difficult to assure such low losses in the DTL during tuneup, selection of (rad-hard) EM quads as the focusing elements seems the prudent design choice

**APT**

## LAMPF Operating Experience

- 1-mA avg. current, 15 mA peak current, 6.7% duty.
- Only 1/4 of 805 MHz rf buckets contain protons.
- Total beam loss from 200 MeV to 800 MeV is < 100 nA to 1000 nA.  
Representative total loss is 400 nA.
- Much of CCL runs with  $\ll 1$  nA/m beam loss ( $2 \times 10^{-7}$ /m fractional loss).
- Larger losses occur in specific locations; explained by acceptance transitions.
- Highest losses in "low-loss" regions are at quadrupoles.
- With a good tune, fractional losses can be  $< 5 \times 10^{-8}$ /m.
- Typical activation levels 2 hours after shutdown from extended operation:  
A few mRem/hour at most locations (*Hands-on maintenance*).
- Large fraction of present losses is due to transient mismatches.

**APT**

## What Loss Levels Can we Estimate for APT Reference Design?

- Beam dynamics simulation codes accurately describe RMS beam behavior.
- With our present understanding we can design the accelerator for minimal RMS emittance growth.
- Simulations strongly suggest that halo growth tracks RMS emittance growth.
- However, the codes don't have the precision to calculate halo growth with the accuracy needed for directly estimating very low losses ( $1 \times 10^{-8}/m$ ).
- **Extrapolation from LAMPF experience coupled with machine design for ultra-low losses** provides high confidence that fractional beam-loss levels low enough for hands-on maintenance are attainable in APT.
- A front-end APT demonstration would permit effectiveness of ultra-low loss design features to be confirmed.

## Beam Halo

- Beam halo is undesirable because it can lead to particle losses and activation of accelerator components.
- Losses at  $2 \times 10^{-8}/m$  level at high energies can create activation that affects hands-on maintenance capability. Simulation codes are not validated experimentally for losses at this level.
- Nonlinear space-charge forces create beam halo and associated growth of emittances.

### EMITTANCE (HALO) GROWTH PARAMETER

$$\frac{q^2 N a U_n}{60 \sqrt{5} \pi \epsilon_0 m c^2 \epsilon^2}$$

- N = number in bunch
- a = bunch radius
- $\epsilon$  = initial emittance
- Un = field energy parameter



## BEAM-LOSS ESTIMATE FOR APT CCL USING NUMERICAL SIMULATION CODES

The numerical simulation codes have a good record for predicting rms emittance growth, especially when the accelerator is modeled using "as-built" parameters. However, there has been no experimental validation for beam losses. Our initial simulation of LAMPF overestimates the beam losses (1.5% predicted verses 0.17% observed) in the CCL. Nevertheless, we have used the LINAC simulation of our "non-ideal" beam to make a loss estimate for the APT CCL. The simulation involved 7500 particles at the RFQ input, and at this level no particles are lost in the CCL. Therefore, our approach has been to reduce the apertures in each of the seven CCL sections until particles are lost. These losses are then extrapolated to an effective aperture radius equal to the real aperture radius, minus two rms beam sizes (3.2 mm), to account for estimated beam mis-steering in the real accelerator.

The loss distribution in each CCL section consists of a peak at the beginning of the section, which is about four lattice-units wide, and a distributed loss background over the rest of the section. We made the conservative assumption that the extrapolated losses were all concentrated in the initial peak. This gave us an extrapolated loss estimate in nA/m. From the loss rate we can derive an activation estimate for one hour after beam shutdown at 30 cm from the beamline. The latter is obtained by assuming that neutrons generated by the lost protons are the principal responsible agent. We use the empirically derived formula

$$\text{Activation (mRem/hr)} = 4 \times \text{loss rate (nA/m)} \times \text{neutron-yield/proton (E}_p\text{)}$$

where the neutron yield per proton is the measured (energy-dependent) value for copper and iron. The factor 4 is chosen so that a 1-nA/m loss gives 20 mRem/hr at 800 MeV, a calibration that is valid for LAMPF.

# APT

## Upper Limit APT Loss/Activation Estimates Based on Simulated (Non-Ideal) Beam Distribution

Energy (MeV)	Loss/Meter (nA/m)	Neutrons per Proton	Estimated Activation (mrem/hr)
20	3000	0.004	50
40	20	0.02	2
80	0.06	0.1	0.02
160	0.06	0.5	0.1
320	0.06	2.	0.5
640	0.06	4.	1
1000	0.06	6.	1

## Other Effects that Could Contribute at Very Low Beam Loss Levels

Nuclear scattering from residual  
gas molecules in beam pipe.



Five to six orders of magnitude  
below level of concern (at  $10^{-7}$  Torr).

Recombination of protons with  
electrons from residual gas to make  $H^0$ .

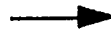

Two to three orders of magnitude  
below level of concern (at  $10^{-7}$  Torr).

Intra-beam scattering of protons  
(Touschek Effect).



Two or more orders of magnitude  
below level of concern.

**APT**

**APT  
MACHINE DESIGN**

*Los Alamos - Brookhaven*

## **Detail of APT Machine Tunnel**

The accelerator modules are relatively short, 2.2 to 4.6 meters, and weigh less than 3000 kg. Each module is equipped with two ion pumps for redundancy that can be connected either directly at the module or remotely in the shielded service tunnel, with only a small conductance loss. The rf waveguide run passes through the shield wall into the service tunnel before penetrating the earth overlay to the klystron sector building above. Shadow shielding serves the purpose of personnel protection in low-radiation areas where hands-on maintenance is feasible. Hot spots are accessible to remote handling by means of force-reflective, master-slave servomanipulators of the MANTIS type used at CERN. The accelerator modules rest on a strongback to which all critically aligned items (i.e., quadrupoles, diagnostics, rf structures) are referenced.

# APT

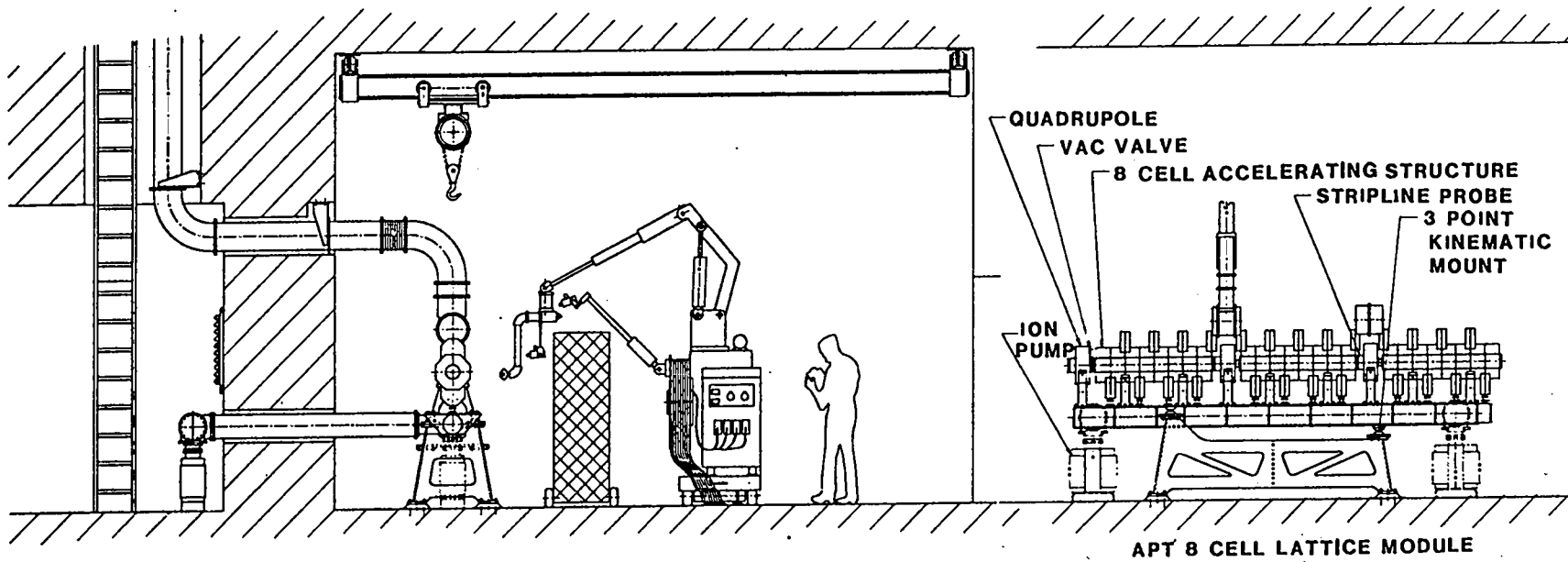

Los Alamos - Brookhaven

## Drift Tube Linac

Two drift tube linacs (DTLs) transmit 125 mA each to the funnel that feeds the coupled cavity linac (CCL). One of these DTLs is shown here. Each DTL is modularized into five individual tanks to evenly distribute the rf power demand. Each DTL tank is driven by two 360-kW cw rf drive loops that operate at 350 MHz. Each module is longitudinally stabilized by post couplers, and each utilizes a girder to support the drift tubes. The girder allows maintenance and alignment to be accomplished off line. Each DTL module is tuned with linearly ramped accelerating fields and is designed to  $2\beta\lambda$  periodicity, which effectively doubles the length of the drift tubes. These longer drift tubes permit larger electromagnetic quadrupoles to be used to provide the required focusing impulses, even with relatively large quadrupole apertures.

# APT

## APT DRIFT TUBE LINAC (ONE CHANNEL)

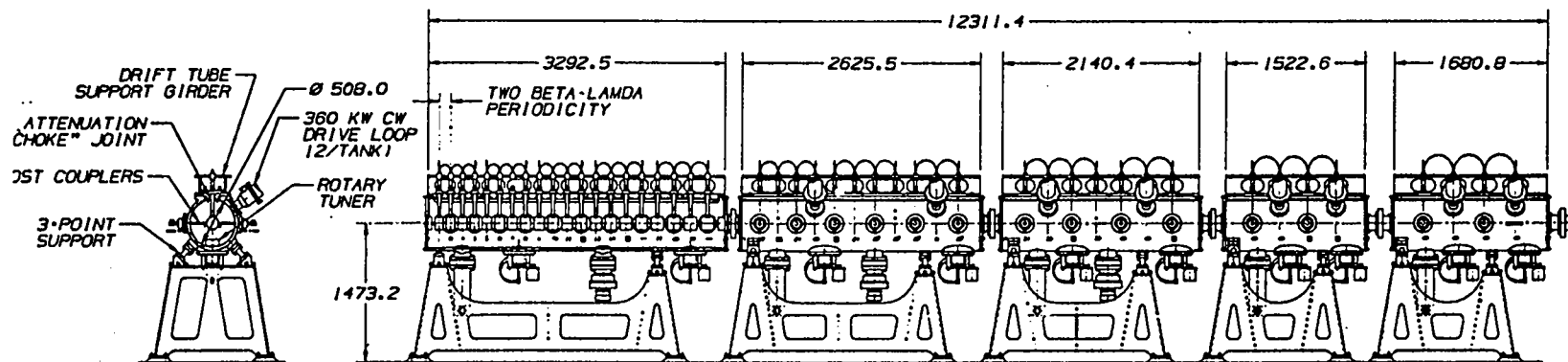

Los Alamos - Brookhaven



## Electromagnetic Quadrupole (EMQ)

The frequency of the DTL is determined in part by the quadrupole that must fit into the drift tube. Shown here is a point design for a "minimal," i.e. smallest, EMQ that we feel is feasible for this purpose. The achievable gradient with this unit is 5 kG/cm at a field coil current density of 3230 A/cm<sup>2</sup>. To achieve sufficient focusing impulse (GL product), it is necessary that double periodicity be used in the design of the DTL. This has been done for APT.

# APT

## SPECIFICATIONS

TYPE: EMQ  
NO. TURNS: 8/POLE  
CURRENT: 224 AMPS  
CURRENT DENSITY:  
3226 A/cm<sup>2</sup>  
POLE TIP FIELD: 4.5 kG  
GRADIENT: 5.0 kG/cm  
LEFF: 6.45 cm  
GL: 32.45 kG  
POWER: 1.35 kW  
VOLTAGE: 6.0 VOLTS  
DELT: 44C PER COIL  
COOLANT: 0.46 gpm

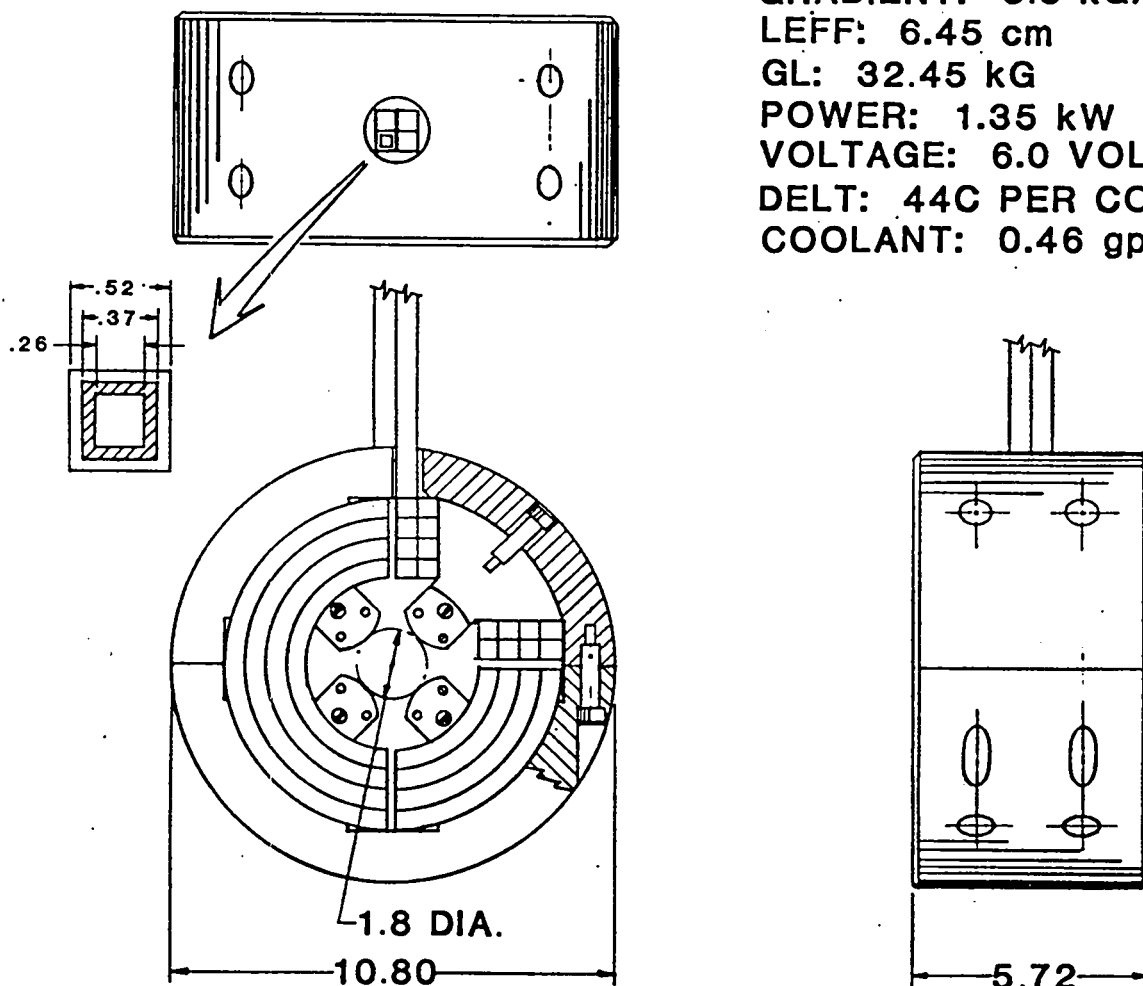

MINIMUM SIZE DRIFT TUBE LINAC QUADRUPOLE  
(350 MHZ, 2.5 MEV, 2BETA-LAMBDA)

## **Typical CCL Accelerator Module**

The number of individual lattice units in each module is determined by the rf power deliverable by a single cw klystron. Shown here is a typical 8-cell lattice module in which three lattice units are combined by means of two bridge couplers into one 1.25-MW module. One bridge coupler is used to drive the entire module. The length of the 8-cell lattice modules vary from 4.2 to 5.1 meters, each weighs about 3000 kg, and 88 are required. Other modules in the machine include clusters of 2-, 3-, 4-, 6-, and 10-cell lattices. All modules are typically mounted on strongback beams designed for minimal deflection. All essential alignment is done in the assembly and tuning laboratory with the strongback mounted in a fashion identical to that employed on line. This is made possible through the use of a 3-point kinematic mounting system that permits installation of an entire module for speed of maintenance and ease of alignment recheck. The thermal dissipation in the modules is about 250 kW. The highest dissipation per accelerating cell is in the 2-cell lattices at the beginning of the CCL. These cells have been analyzed to verify that water cooling is feasible and that cell detuning resulting from thermal distortion is minimal.

# APT

## APT COUPLED-CAVITY ACCELERATING STRUCTURE (8-CELL LATTICE UNITS)

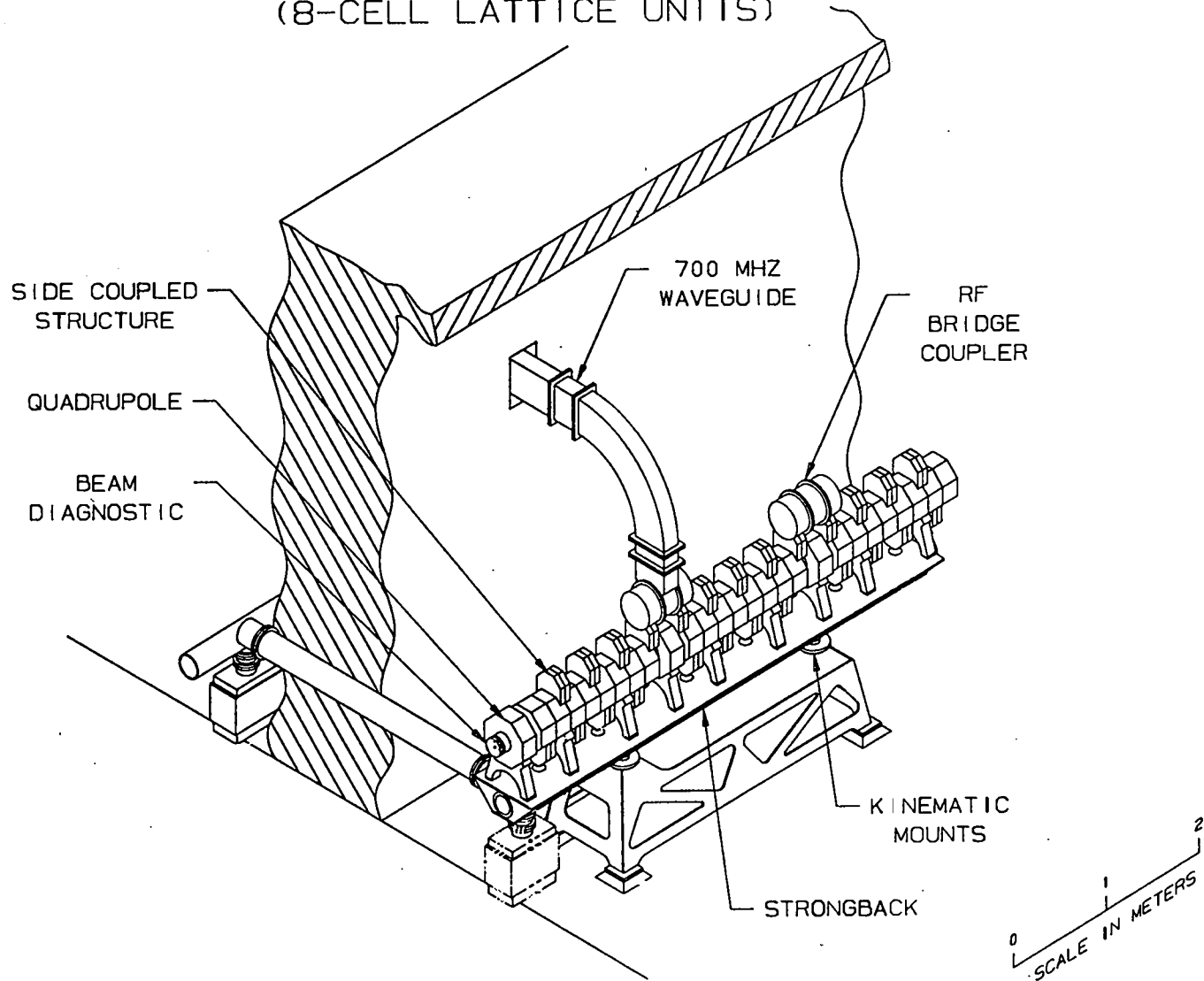

Los Alamos - Brookhaven

**APT**

**APT CCL Section 5**

Dimensions in cm  
Average  $\beta\lambda = 31.45$

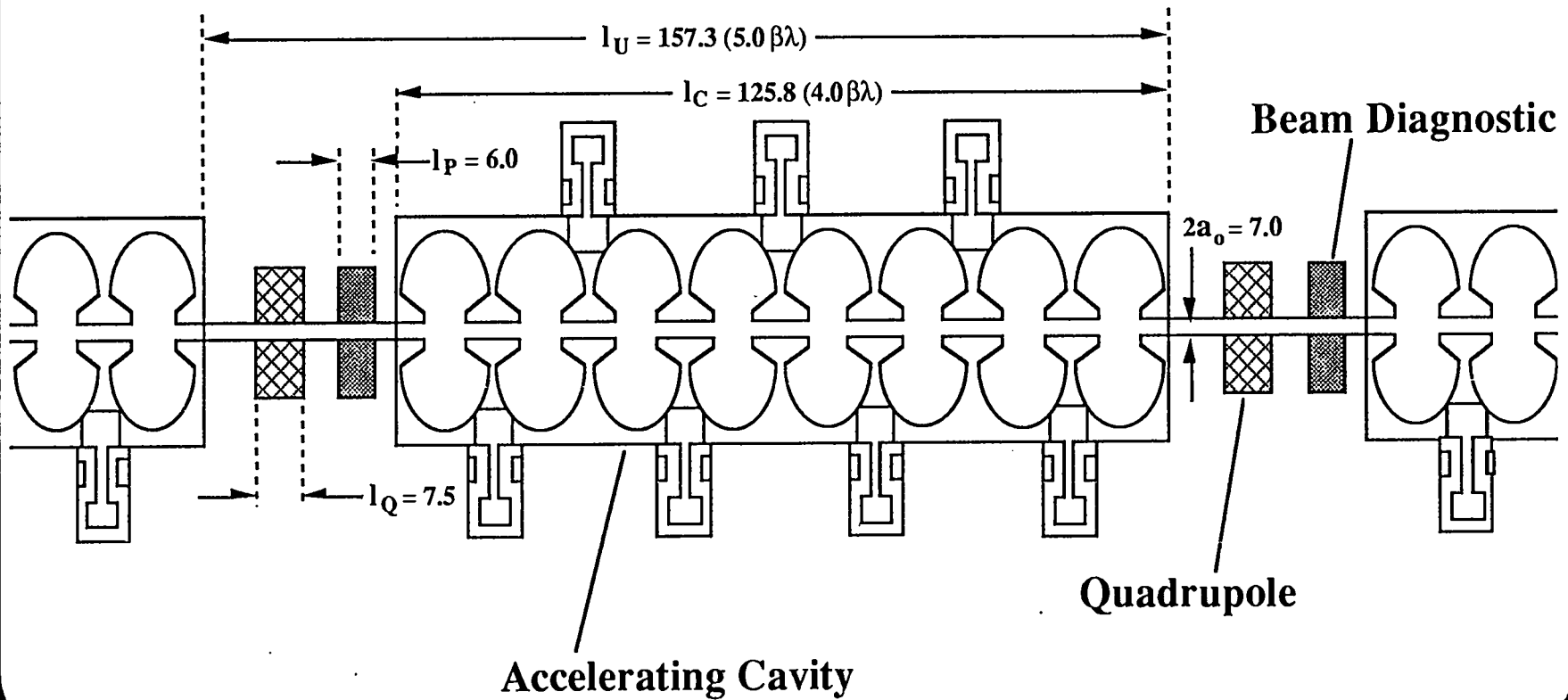

# APT

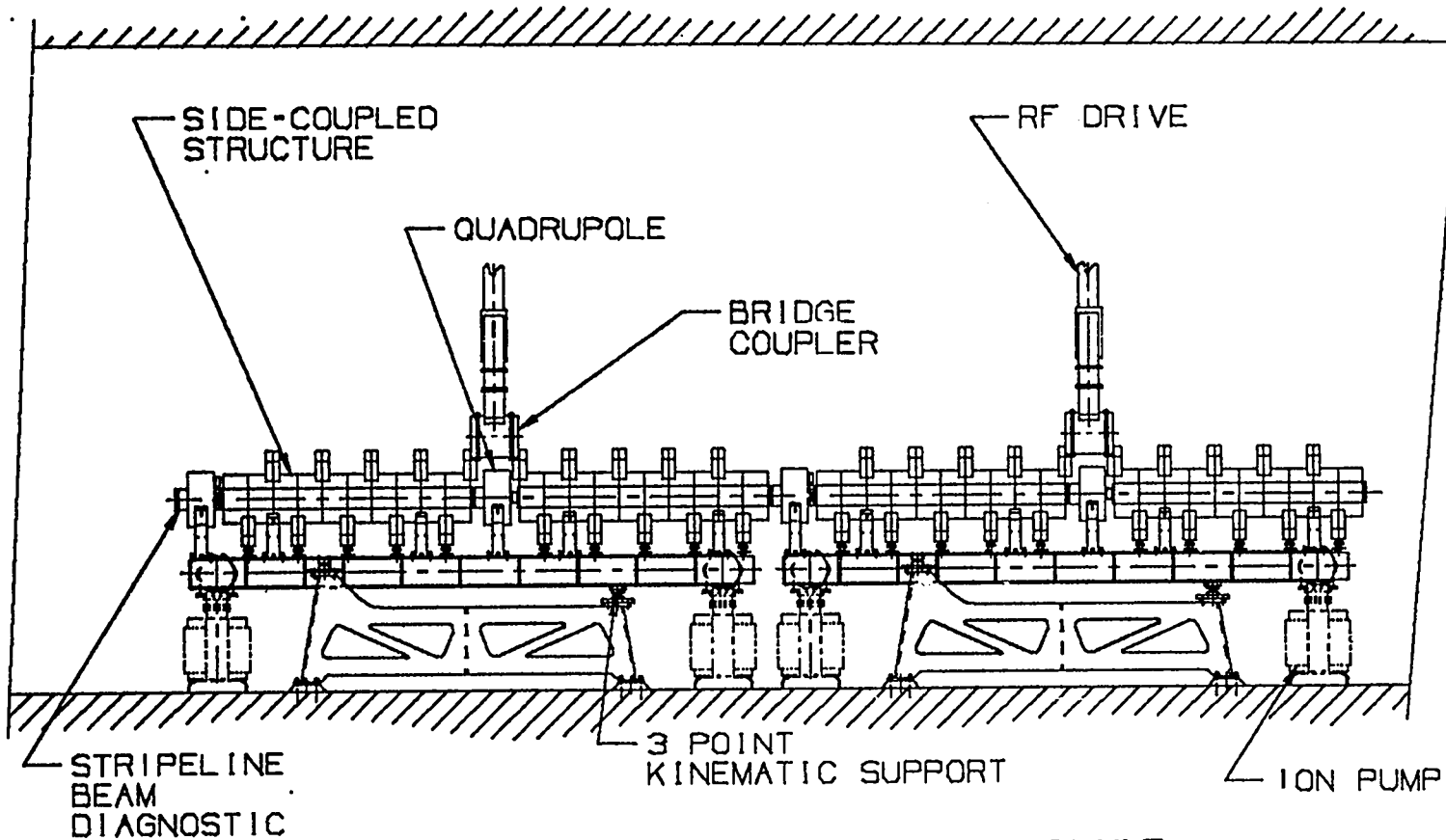

**APT 10-CELL CCL ACCELERATING MODULE**

## Thermal Analysis and cw-coupled Cavity Linacs

A thermal analysis was made of the APT CCL 2-cell lattice structure. This structure dissipates 52 kW and is the most thermally stressed structure in the APT CCL. An attempt has been made to design all of the APT CCL cavities in such a way that the thermal dissipation is about  $20 \text{ W/cm}^2$  max. In the 2-cell case, this dissipation varied from  $12\text{-}27 \text{ W/cm}^2$ , and the analysis proved that water cooling was feasible. The peak surface temperature reached  $65^\circ \text{C}$  on the cavity nose, and the total change in gap was  $0.0008 \text{ cm}$ . With more design time, this detuning effect could be reduced further.

A method of constructing a coupled cavity linac is shown here. This is a cw design for a racetrack microtron side-coupled structure. The means of machining the coupling and accelerating cells into the same copper forging is shown, as well as the cooling channels machined into the plenum region prior to brazing. We conclude from both experience and analysis that the CCL system for APT can be designed for cw operation.

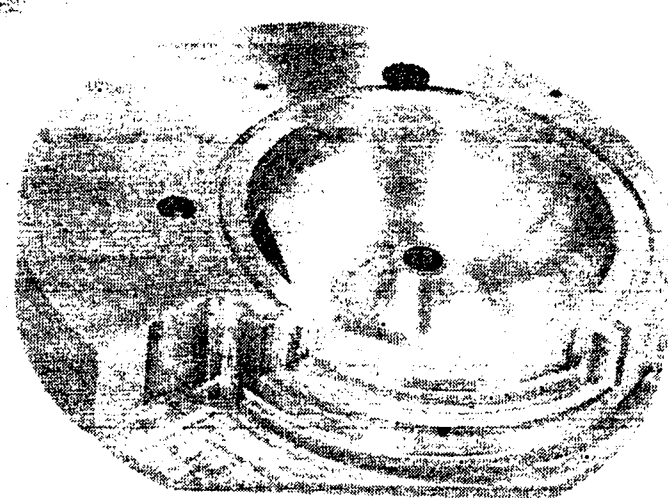
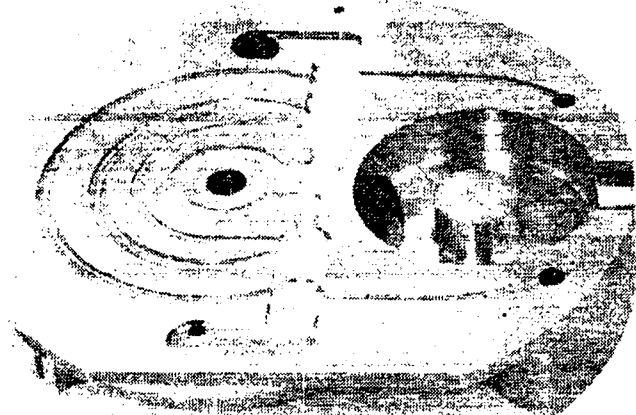
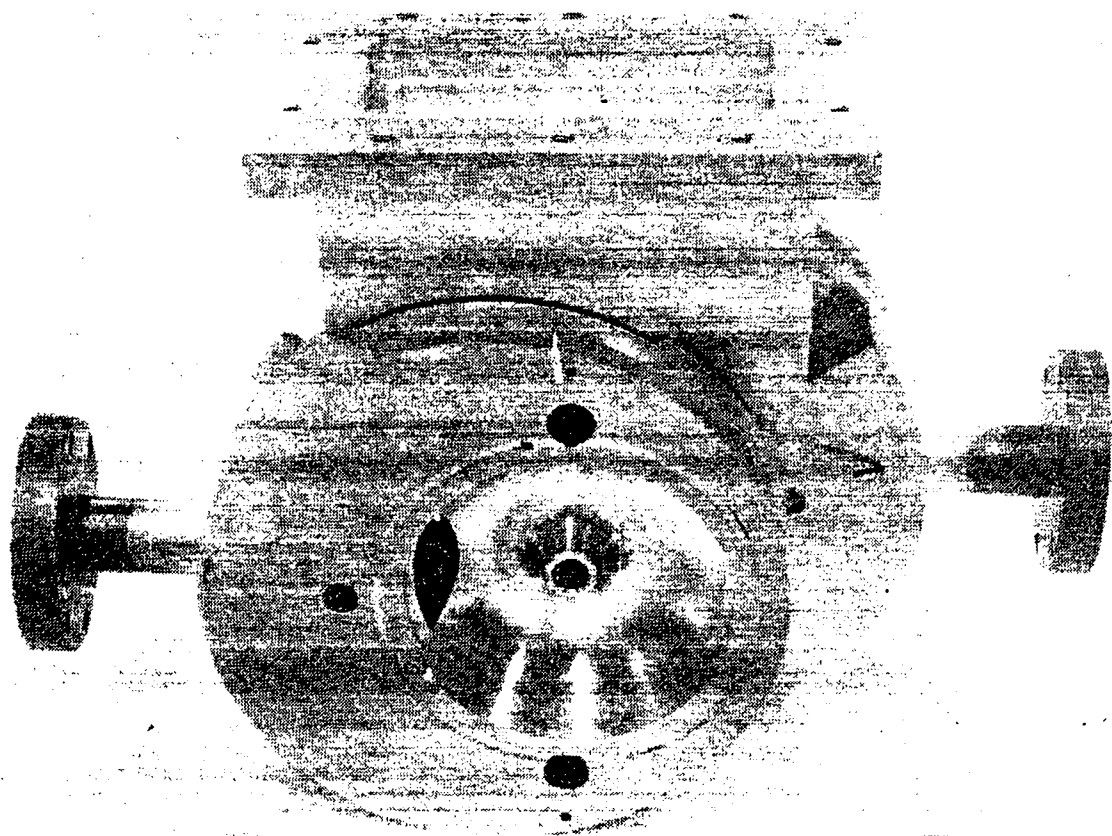



## **Experimental 500-kW rf Drive Loop**

This rf drive loop was developed as part of the GTA Program. It is cut for 425 MHz and was designed for 5% duty operation at 500-kW peak and 2-msec pulse length. Loops of this size will be required for the DTL portion of APT where two will be used on each DTL module. Extrapolation to 360 kW cw is a significant development step but the above loops have been operated in short pulse mode at over 1-MW peak, so the basic rf design has been proven. What remains is to develop adequately the cooling system of the loop to permit cw operation and to thoroughly test the loop and window for reliability.

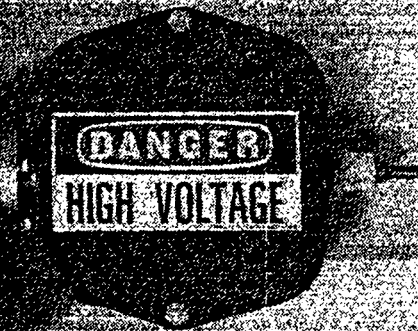
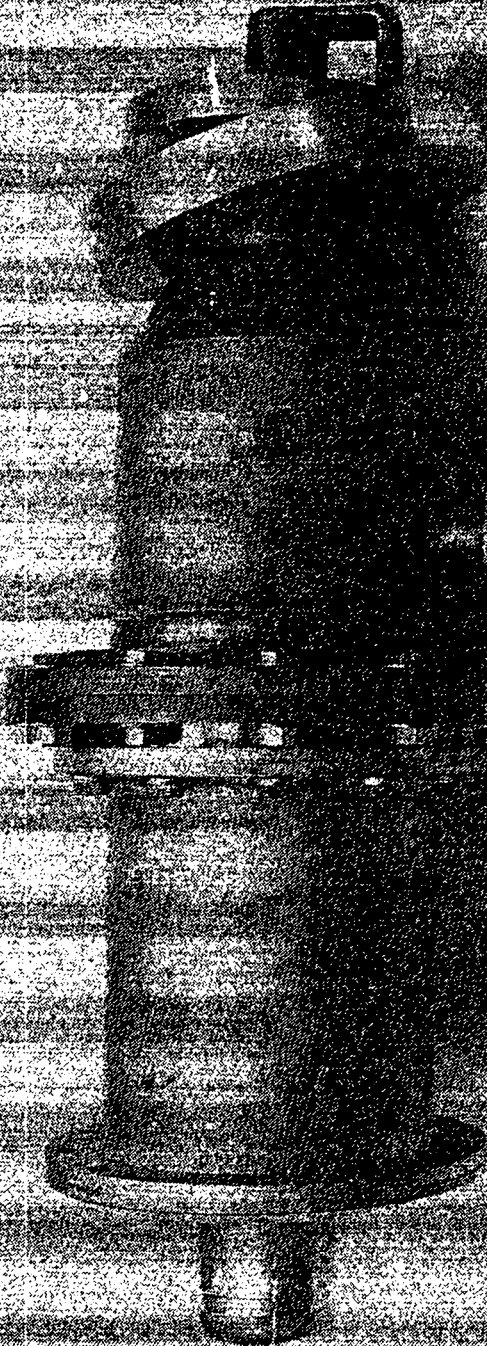
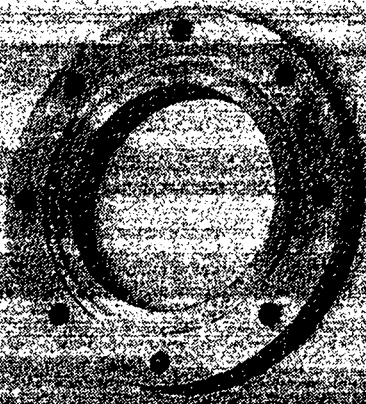

## **Alignment**

Despite the large ratio of bore diameter to beam diameter, alignment of APT will be important to reduce as much as possible losses from the powerful proton beam. Shown here is an effective means of determining the magnetic center alignment in a typical DTL module. This technique uses a taut wire stretched through the system which is pulsed to induce velocity impulses at each quadrupole. The impulses are then decoded for alignment data by a fast detector. In the CCL we propose to use proximity sensors which can monitor the alignment of each quadrupole. It is possible that actuators can be designed to provide for remote realignment if such extreme measures are deemed necessary.

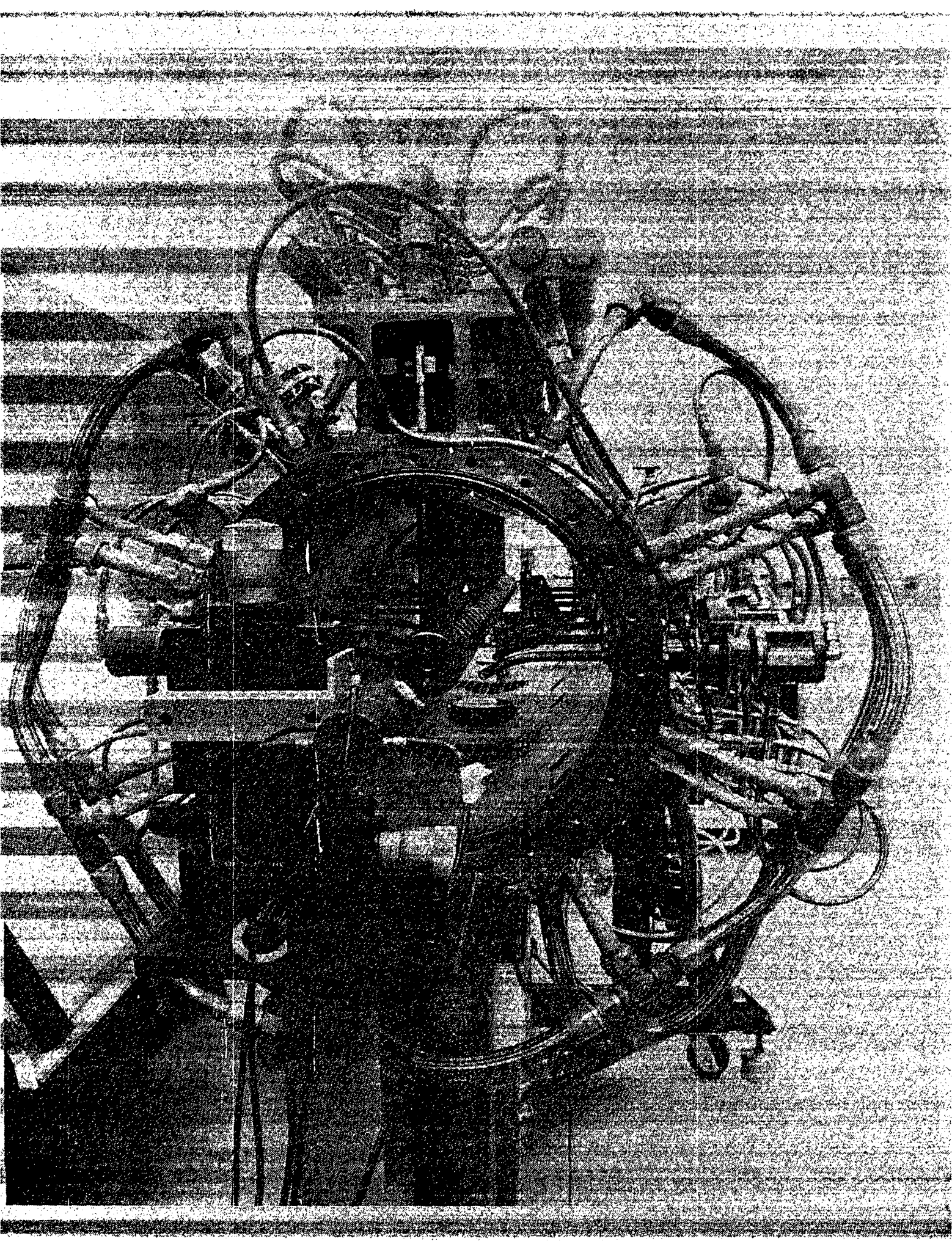

**APT**

**APT  
RF POWER  
SYSTEM**

*Los Alamos - Brookhaven*

## Current Accelerators with Applicable Characteristics Compared to APT

<u>Accel.</u>	<u>Location</u>	<u>Freq. (MHz)</u>	<u># of Stations</u>	<u>Peak MW</u>	<u>Duty</u>	<u>1st Beam</u>
LAMPF	LANL	805	44	40	11%	1972
LEP	CERN	350	16	16	CW	1989
TRISTAN	KEK	508	30	22	CW	1986
SLAC	SLAC	2856	247	16000	.03%	1966
INR-MMFL	Moscow	991	28	130	1%	1990
APT		700	~500	510	CW	

Information from "Catalogue of High Energy Accelerators", August, 1989



## **Klystron Choice as RF Generator**

All large, high frequency accelerators use klystrons because of long life and simplicity of the klystron rf system.

Several other generators are possible, but none has the proven advantages in efficiency, output power capability, and lifetime that the klystron has demonstrated.

The LAMPF klystrons have a life of 80,000 hours, and so do the BMEWS klystrons.

The LEP—CERN cw 1 MW 352 MHz klystrons are in production and were designed for 25,000 hour life.

## **Klystron Life**

The M-type cathode has been developed for spacecraft applications, and its wear-out life has been measured at 200,000 hours in the Laboratory, by operation at elevated temperatures.

Although high power is generally detrimental to reliability, the klystron vendors believe that a 50,000 to 100,000 hour life is an achievable goal for a 1 to 1.5 MW cw klystron.

The klystron will have built-in instrumentation, so that most wear-out failures can be predicted, and the klystron replaced during a maintenance cycle.

## **Klystron Operation**

Operate 24 hours per day, for months at a time.

One four-hour period per week used to replace components that have become weak. Rest of rf system stays on.

Quick disconnections used on the klystron; amplifier module is changeable in less than two hours.

All high power components designed and tested for higher power than normal operation, to greatly increase system reliability.



# APT

## Vendor Design Proposal for 700-MHz 1-MW cw Klystron

	700-MHz Design	508-MHz Measured
cw power (kW)	1050	1220
Beam voltage (kV)	90	93.5
Beam current (A)	18	19.4
Efficiency (%)	65	67.1
Cathode diameter (mm)	70	70
Power gain (dB)	> 50	56
Overall length (mm)	3765	4345

The design is not optimized, but was made without charge by a klystron vendor to give us an estimate of the klystron's parameters.

Note that the klystron is large but smaller than the 1.2-MW, 508-MHz production model.

*Los Alamos - Brookhaven*

# APT

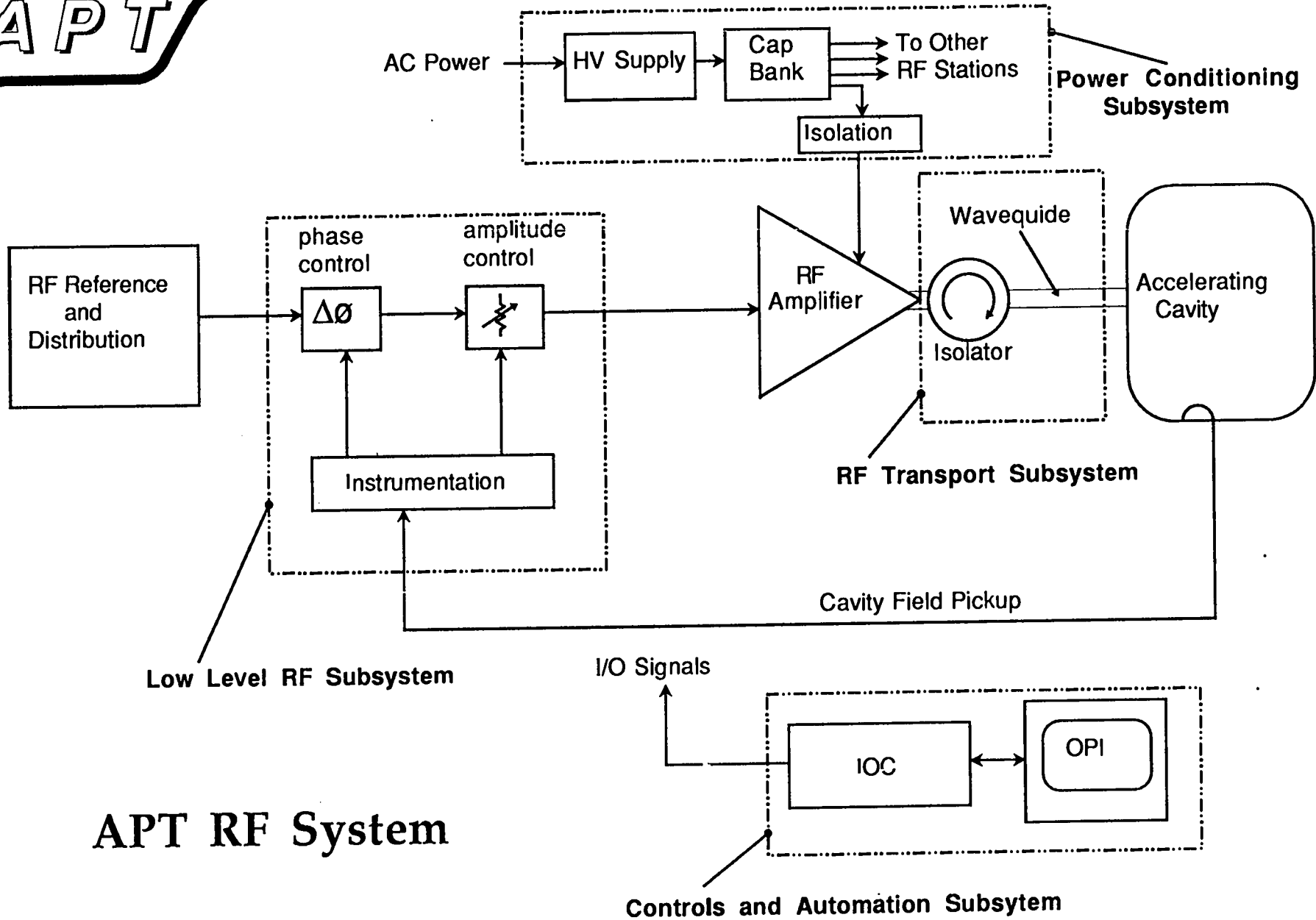

## APT RF System

## **Low Level RF Subsystem**

The regulation levels in the accelerator cavities are primarily determined by the loop gain and loop phase margin. In addition the loop bandwidth is inversely proportional to the loop gain and the loop phase margin. CW accelerators do not have the turn-on transients which are present in pulsed accelerators and which are the primary reason for wide bandwidth in the low level control system. As a result, the low level control system for APT will be able to achieve regulation levels of a few tenths of a percent in amplitude and a few tenths of a degree in phase.

# APT

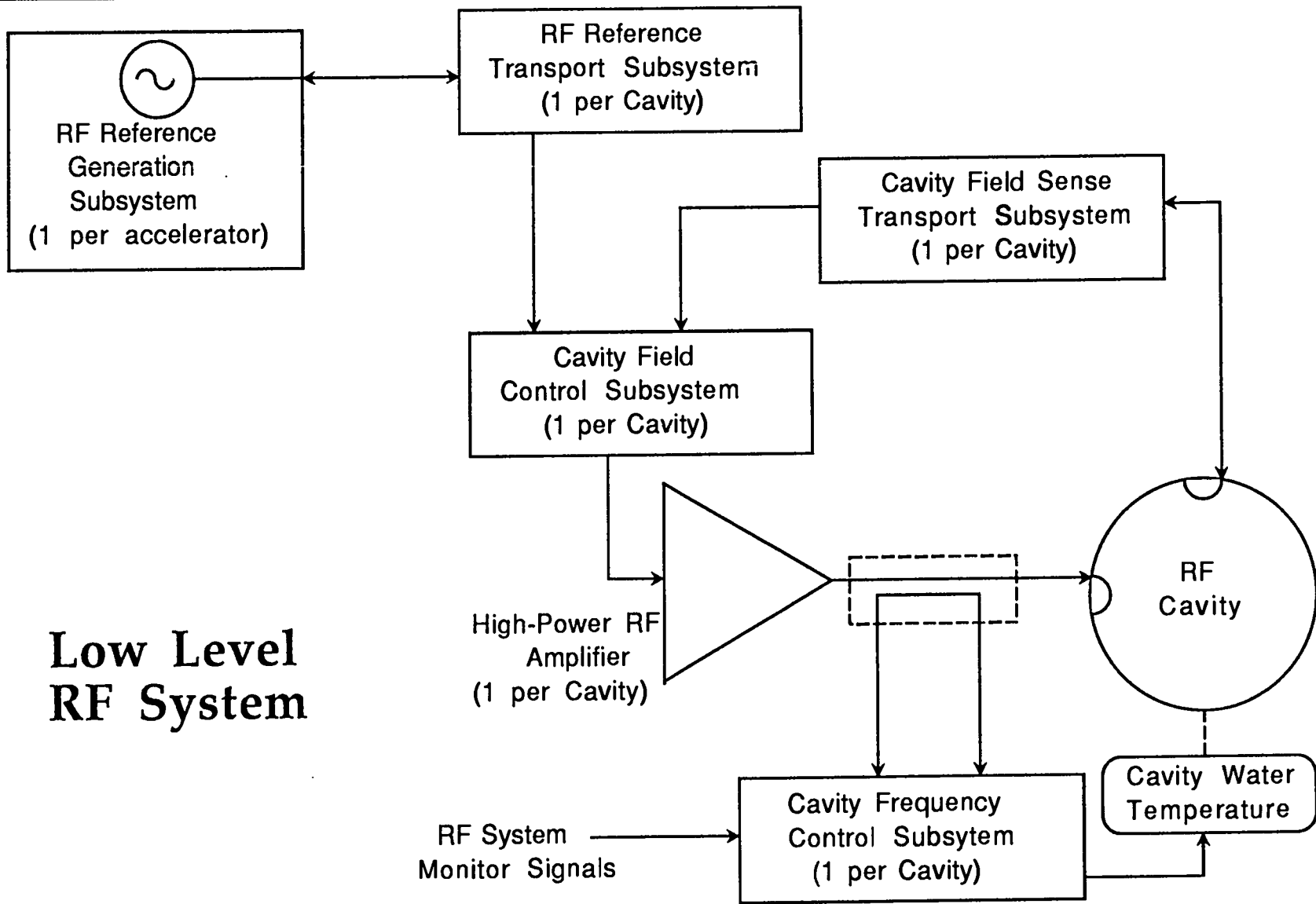

## Low Level RF System

## **RF System Protection**

The RF system is protected from faults in a number of ways. The reflected RF power is absorbed by the circulator in the waveguide. Overcurrent and overvoltage faults in the klystron are handled by a crowbar on the high voltage input. Long term wearout of the klystron will be determined by monitoring the gain and body power of the klystron. In addition many points within the klystron will be monitored for increasing temperature.

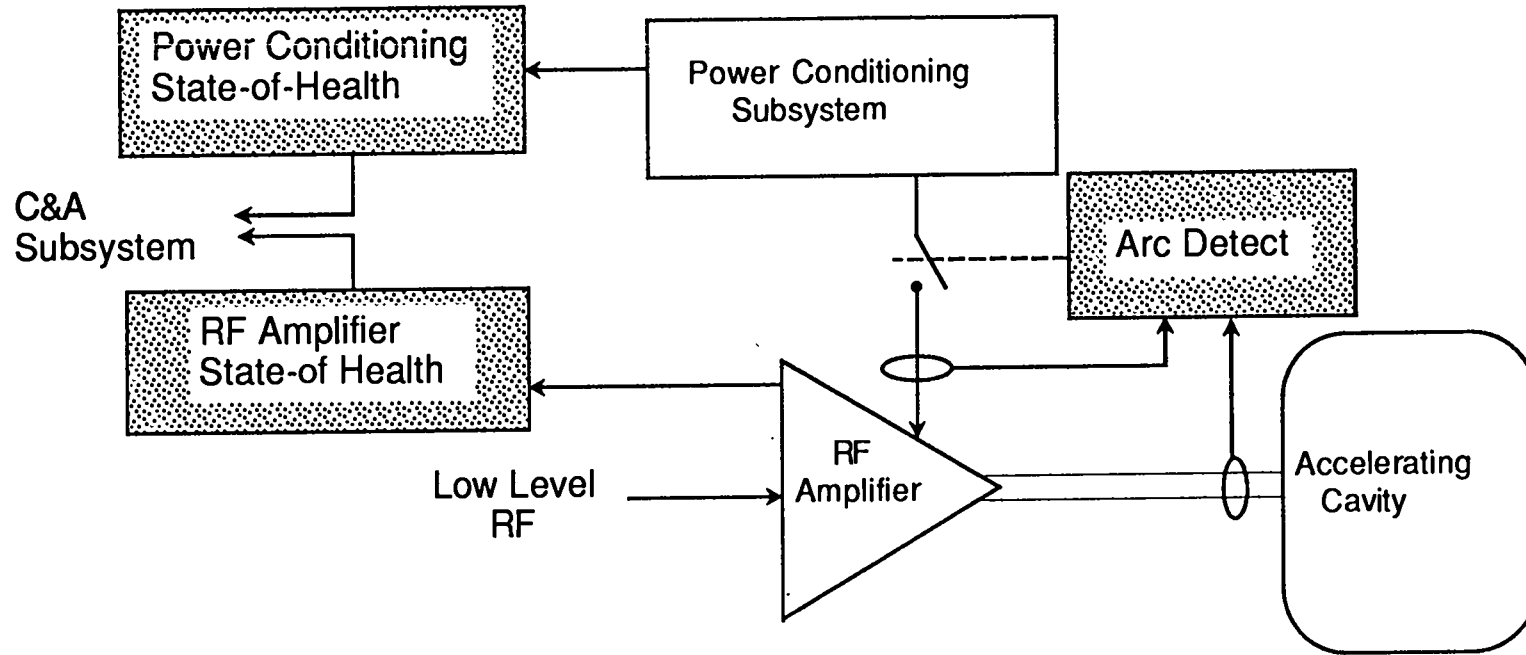

## RF System Protection

# APT

## RF System Fault Handling

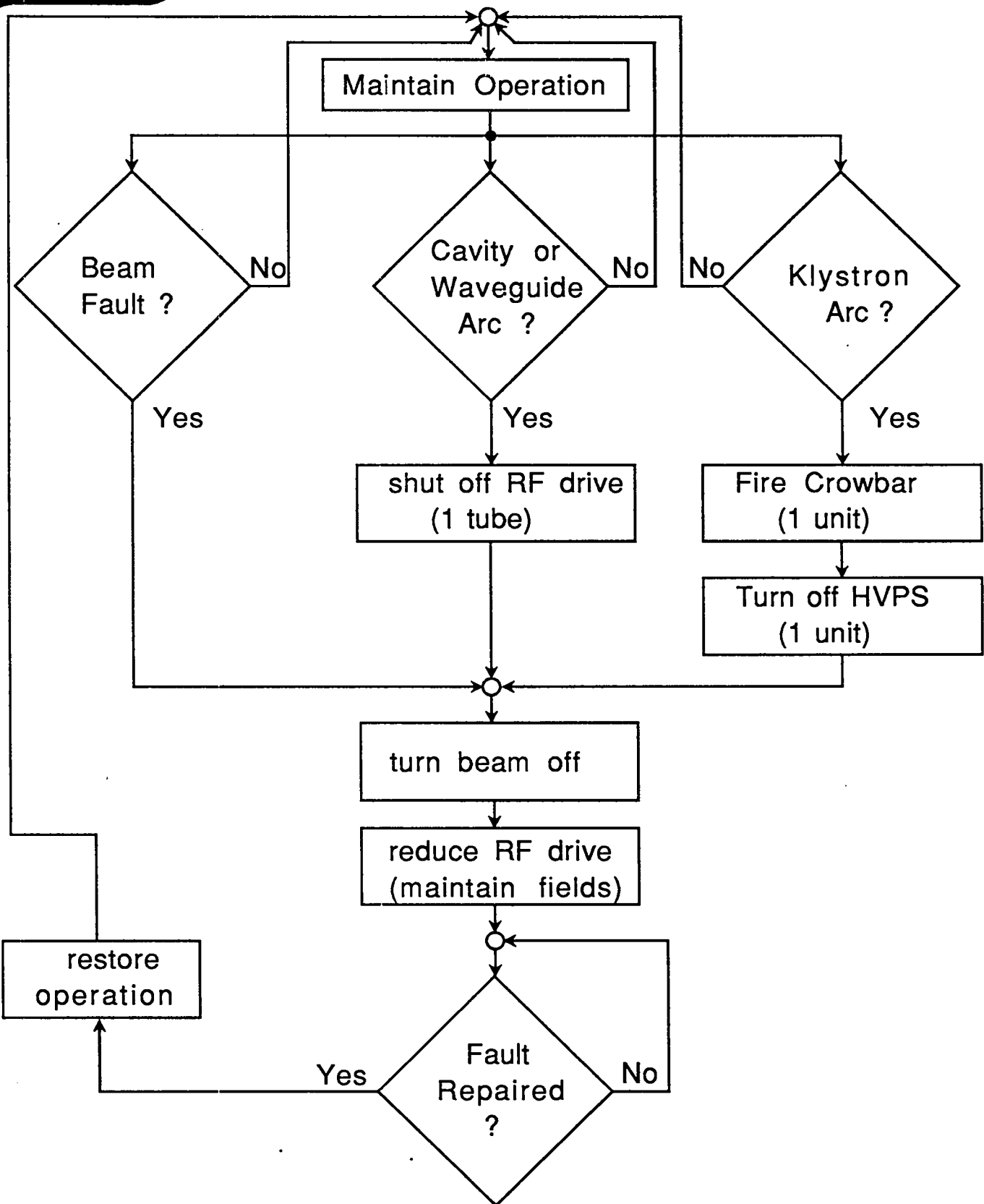

## Reliability Budget for RF System

Subsystem	MTBF k hrs.	Number Installed	Failures/ yr.	Percent Anticipated	Unanticipated failures/yr.	Time to Repair (hrs.)	Hours out/yr.
Klystron	50	482	84	75	21	3	63
Power Supply	150	80	4	50	2	6	12
Power Conditioning	100	80	7	50	4	5	20
Low Level RF	100	482	42	50	21	2	42
RF Transport	150	482	28	50	14	4	56
Water System	20	80	35	85	5	5	25
Preventive maintenance			8 hrs/week				416
							<b>634</b>
							<b>93</b>



## RF Component Reliability

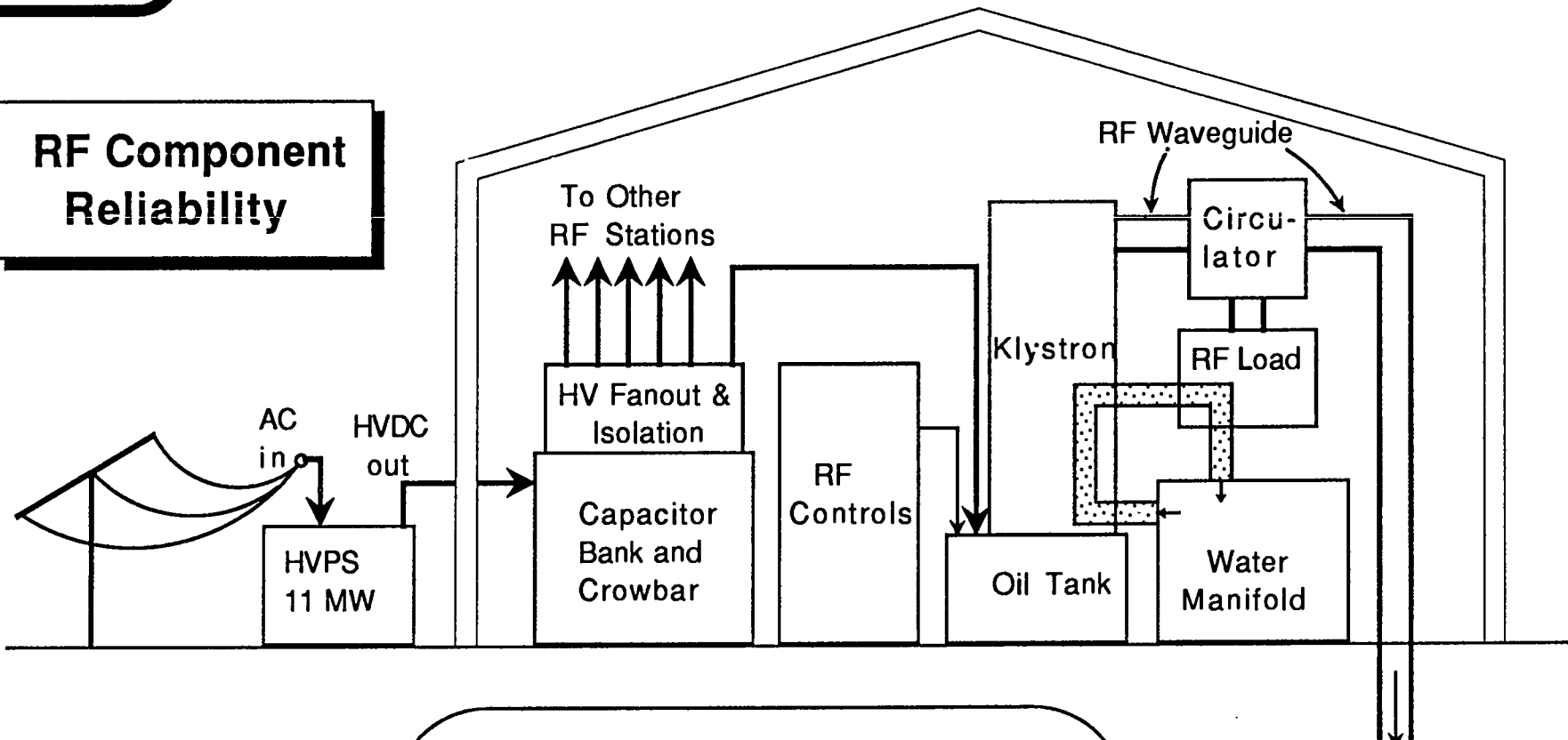

**Component MTBF, hrs (estimated)**

HVPS	150,000
Power Conditioning	100,000
RF Controls	100,000
Klystron	50,000
RF Transport	150,000
Water System	20,000

## LEP Cw Klystron

The photograph shows the LEP-CERN 1.1 MW CW klystron which operates at 352 MHz. Over 20 of these tubes have been built, and they have DC-to-RF efficiencies of 67 to 70%.

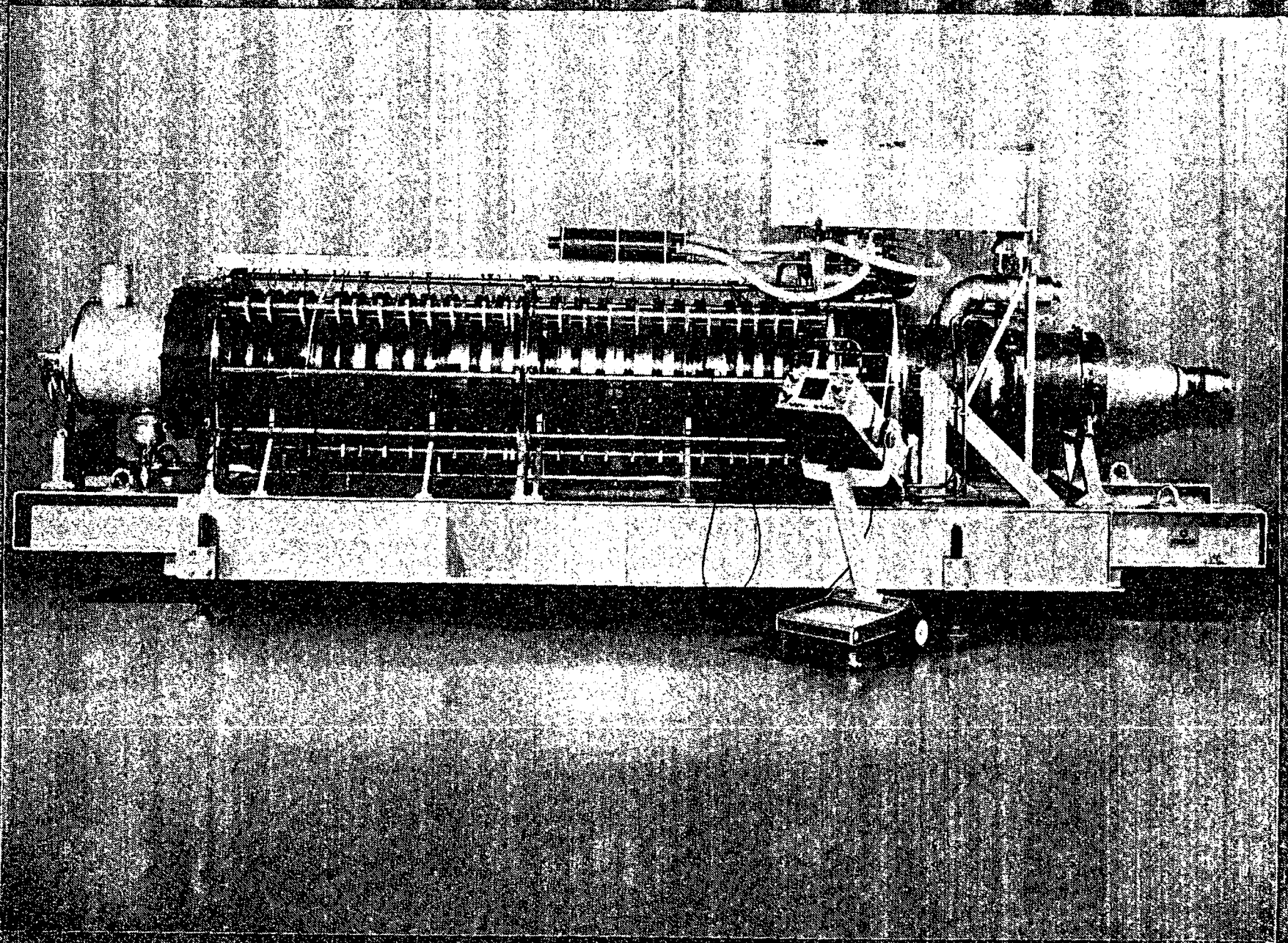

## **Klystron Lifetime**

Klystron lifetime is determined by a multitude of factors, but the cathode lifetime is by far the dominant factor. Although high power is generally detrimental to cathode reliability, the klystron vendors believe that a 50,000 to 100,000-hr life is achievable in a 1- to 1.5-MW cw klystron. In addition, extensive instrumentation on the klystron can allow most wearout failures to be predicted. This would allow replacement of the klystron during regular maintenance periods without loss of running time.

Current experience with high power cw klystrons is limited at this point. The PEP ring at SLAC has 12 each 0.5-MW cw klystrons at 353 MHz. Three of the original twelve klystrons (installed in 1977) are still operating after 60,000 hours of operation. One design fault and one material fault have been corrected, and the second generation klystrons are expected to last much longer. Estimates for the first-generation klystron life is 40,000 hours, but it is too early to estimate the life of the newer klystrons. The TRISTAN ring at KEK in Japan now has over 20 cw klystrons with output power between 0.8 and 1.2 MW at 508 MHz. This facility is still new, but one klystron has accumulated over 12,000 hours.

Cw klystrons with output rf powers close to 1 MW have been in operation on PETRA at DESY in Hamburg, West Germany since 1978. Eight 500 MHz tubes were initially installed--this number was doubled in subsequent upgrade programs. Tubes at 1000 MHz were also added for second harmonic cavities. Detailed information on operation, maintenance, lifetime and possible failure modes is being obtained. The information supports our expectations of 50,000 hour lifetime.

## LAMPF Klystron Lifetime Experience

**Parameters:** 805 MHz, 1.25 MW (peak power)  
12% duty (1 ms pulses, 120 pps)

	VARIAN-862A	LITTON-5120A
Number of klystrons	70	26
Number of sockets	39	7
Total operating hours		
• High-voltage on	3,170 K	530 K
• Filament on	3,960 K	680 K
Average operating hours		
• High-voltage on	31 K	9.2 K
• Filament on	39 K	11.8 K
Long-life performance	<b>20 tubes with &gt; 75 K hours</b>	<b>5 tubes with &gt; 50 K hours</b>

**APT**

**MAINTENANCE  
RELIABILITY  
SAFETY  
REMOTE OPERATION**

*Los Alamos - Brookhaven*

**APT**

## **Maintenance Philosophy in APT Design**

- Operational goal would be hands-on maintenance of accelerator, but recognize that some components or zones may require remote handling.
- Design machine components for servicing with (proven) remote handling technology (CERN, LAMPF, PSI) if required.
- Include remote maintenance equipment in facility cost estimate.
- Design tunnel and handling facilities for compatibility with remote servicing.

## Maintenance and Failures

Experience at accelerator facilities was used in determining the most likely items that would fail and those that would require routine maintenance. Facilities such as LAMPF have operated many years as production accelerators and they have good records of component failures, repair times, down times and maintenance procedures. Manufacturers were also contacted to determine expected performance of components and the necessary servicing or maintenance requirements. Beside each item in the chart is listed the number of that item used for APT.

Although most operating high power linacs are pulsed, the vacuum pumps are on continuously with pumping loads related to the duty cycle of the machine. Based on available performance data, extrapolation to APT operating conditions and re-fabrication experience, the results shown in the chart were determined. An unexpected failure that could possibly shut down the accelerator would consist of at least four pumps adjacent to each other, failing catastrophically—either from the pump itself or its power supply. Such a scenario has never occurred at existing facilities; nevertheless, the possibility was estimated at once every 10 years for a 2 hour shutdown.

Data from operation of the RTNS-II cw injector at LLNL (80 hours per week for several years) showed that the ion source could be replaced in one hour and the filament in one half hour. Filament lifetime averaged 200 hours and the molybdenum electrodes averaged 1000 hours. Based on this data and data from other beam production facilities, spare ion sources, power supplies and injector components will be kept on hand. Several ion sources will be in a state of readiness—for immediate replacement on the accelerator.

Summing the total of unscheduled down time shown in the chart gives an expected 96% availability for the APT accelerator.



## Issue—Maintenance, Failures

Item	<u>Down Times Per Year</u>			<u>Estimated Time Off Per Year</u>
	Total	Anticipated	Unexpected	
Ion Pump (1000)	250	250	0.1	500 hours (maintenance)
Tubomolecular Pumps up to 200	20	20	0	used during maintenance
RF Klystron (500)	80	60	20	180 hours (maintenance) <span style="border: 1px solid black; padding: 2px;">60 hours</span>
Ion Source (2)	50	50	0.1	150 hours (maintenance)
Cooling Pumps (80)	34	29	5	145 hours (maintenance) <span style="border: 1px solid black; padding: 2px;">25 hours</span>
RF Transport (500)	28	14	14	56 hours (maintenance) <span style="border: 1px solid black; padding: 2px;">56 hours</span>
Quadrupole DTL	0.2	0	0.2	<span style="border: 1px solid black; padding: 2px;">2 weeks in 5 years</span>
Magnets (1600) CCL	2	0	2	<span style="border: 1px solid black; padding: 2px;">8 hours (+10 if remote handling)</span>
Micellaneous Items	50	0	50	<span style="border: 1px solid black; padding: 2px;">150 hours</span>

Diagnostic Element (2000)    redundancy (high density) for controls and interlocks

Scheduled Preventative Maintenance—8 hours/week

## Issue—Reliability and Safety

- Selection of Rad-hard Components
  - No pm quadrupoles
  - No plastics, elastomers in vicinity of beamline
- Employ hard wiring with redundant detectors for fast protect system
- Employ beam dumps and fast kickers to eject beam from accelerator
- Beam shutdown in 30  $\mu$ s
- Design linac to account for misalignments and missteering
- Spare parts inventory for major and minor items
  - rf system components
  - Extra klystrons in spare sockets—conditioned
  - Power supplies
  - Standby ion sources
  - Pumps and pump parts
- Redundant diagnostics
- Modularity of construction, accelerator sections and rf stations
- Component monitoring—performance change/aging
- QA, safety programs

- \*Vacuum pump rebuild facility
- \*Klystron rebuild facility
- \*Vacuum isolation of beam line

## Beam Control

- Stray beam energy deposition high; rapid action required to shut off beam in event of magnet failure or control loss
- Carefully planned fast-protect system similar to LAMPF; Fast detection of beam loss and immediate injector shutoff
- Note magnet time constants  $\approx 0.1$  sec
- Beam shutoff-time budget:
  - $\approx 10 \mu\text{s}$  beam left in linac
  - $\approx 10 \mu\text{s}$  shutoff-signal propagation time
  - $\approx 10 \mu\text{s}$  shutoff time
  - or  $\approx 30 \mu\text{s}$  response time
- Even if failure is instantaneous:
  - Assuming a  $3 \times 3$  mm struck area and  $30 \mu\text{s}$  deposition, a 0.08 in thick beam pipe will have temperature rise of  $300^\circ\text{C}$ .
- Similar figures hold for failure of magnets focusing on target. The beam will be much larger than mm size; rapid detection will allow small temperature changes.
- Similar protection system has worked reliably for LAMPF

## Transport Diagnostics

- Profile measurements
  - Flying wire scanner
  - 10 m/s scan speed
- Position centroid measurements
  - Stripline device responds to beam high-frequency field
  - Down convert to 10 MHz for low processing costs
  - Part of jitter control system
- Momentum spread and energy centroid
  - Dispersed profile in bend
  - Phase measurement at two points in periodic line
- Fast protect and activation protect system

## Jitter Effects

- Linear beam - jitter proportional to  $M$ , the beam magnification,  $\sim 1000$  for APT
- Effect ameliorated by nonlinear focusing,  $0.1\sigma$  jitter approaching acceptability
- Control scheme in periodic line developed for GTA
  - Two fast deflectors control angle and position using feedback circuitry

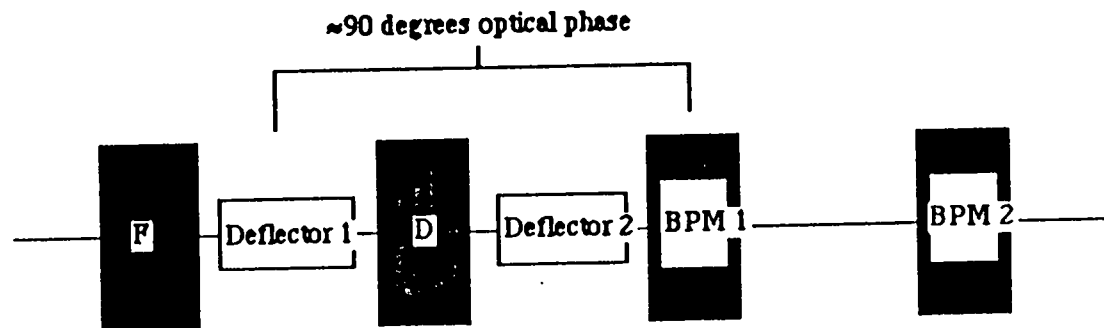

# Remote Operations and Maintenance Systems Applicable to APT

- **Advanced master-slave servomanipulators (MSSM) for remote servicing of radioactive accelerator components are in routine use at LAMPF and CERN.**
- **These MSSM systems have evolved to a high level of sophistication and effectiveness in 15 years of technology development.**
- **Force reflective arms combined with color TV and audio feedback reproduce the worksite environment for the operator with precision, feel, and presence.**
- **The MSSM operator works in a safe, comfortable location that can be almost arbitrarily distant from the accelerator maintenance site.**
- **The Monitor at LAMPF is designed to repair deep target cells in the main proton beamline, at radiation levels exceeding 100,000 Rem/hour.**
- **The Mantis at CERN is a self-propelled mobile MSSM unit adapted to work on long accelerator beam lines.**
- **Both systems are capable of all operations that a man could perform through the use of air-, electric-, and hydraulically-actuated tools.**
- **The MSSMs are adaptable to computer control (robotics), and work effectively with other remote-controlled machinery, such as a bridge crane.**

## Remote Maintenance Systems (MANTIS)

This master-slave-servomanipulator (MSSM) system is in use at CERN for mobile remote maintenance operations on the accelerator ring and targets. The system utilizes servo arms with force reflection, i.e., "feel," that, along with TV eyes and microphones, provides the remote operator with a sense of presence. All conceivable operations such as grinding, cutting, welding, soldering, seal replacement, and component replacement can be achieved with this equipment. The operator is located remotely, connected electrically via cables to the MSSM equipment. The MANTIS is self-propelled and can "find" its target. It should be noted, however, that although most manual functions can be performed with this equipment, its remote nature requires that about 10 times as much time be allowed compared to hands-on operations.

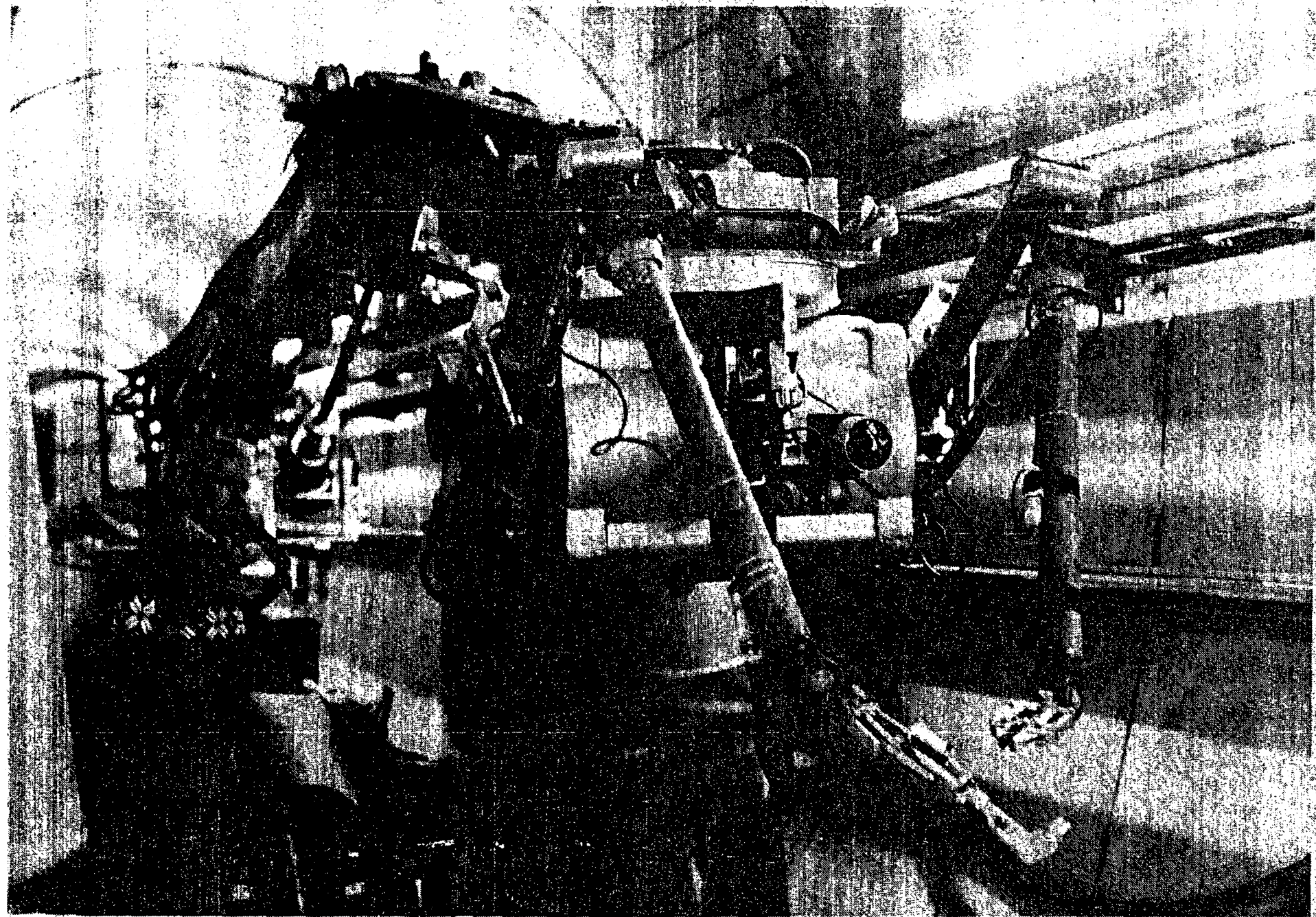



## **Remote Maintenance Systems (MONITOR)**

This MSSM system is in use at LAMPF. It is similar to MANTIS in its ability to do remote maintenance but is not designed as a self-propelled mobile unit. MONITOR is moved into position over deep-pit target cells by means of a crane. MONITOR then reaches into the hot area; it has operated in regions exceeding 100,000 Rem/hour. Obviously, all conceivable operations must be accomplished with this equipment because there is no question of any hands-on maintenance. The servoarms are commercial devices that can use a variety of electrical and air-driven tools. All MSSM systems such as MANTIS and MONITOR are adaptable to limited robotic operations with essential system redesign.

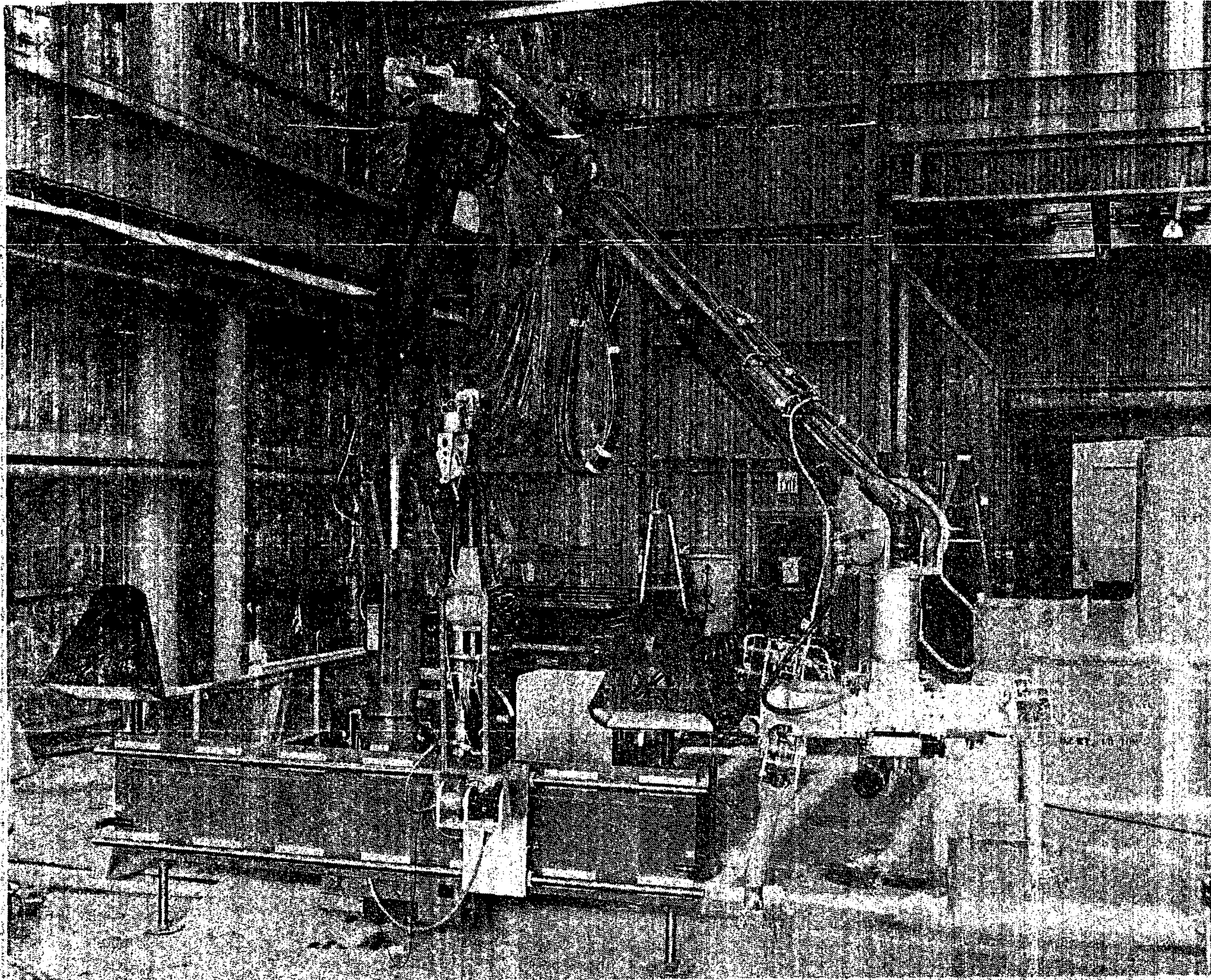

1932 2812

## Issue - Operation and Turn-On

### Turn-On

- Pulsed to establish rf fields in structures —to cw
- CW for low beam current (providing transport OK)
- Either —cw and increase current  
—pulsed with full current and increase duty cycle

### Operation

- Monitoring beam loss, operation and radiation
- Monitoring rf "burps"
- Control on phase, amplitude, current and energy, redundant and numerous diagnostics

**APT**

## Issue - Power

- Full scale production plant requires nearly 1 GWe

### Question

- If you shut off the beam or change operating conditions can the feed line handle the surge?

### Answer

- The klystrons will be able to operate with full power to the collector; therefore, one can operate as a relatively flat load for periods as negotiated.

### Beam Wakefields and Beam Breakup Instability in CCL

- Wakefield amplitude is about 1000 times smaller effect than accelerating voltage in each cell.
- The 250 mA current is well below threshold (40A) for the regenerative beam-breakup instability.
- Simulations show that because dipole-mode frequency changes with  $\beta$  the cumulative beam breakup instability can be controlled in all CCL sections.

**APT**

Reserve Viewgraphs:

**Neutronic Calculations  
Data Base Development  
Target Protection System**

APT Target Lattice

James R. Powell

Brookhaven National Laboratory

*Los Alamos - Brookhaven*

## ESTIMATION OF TRITIUM PRODUCTION CONSIDERATIONS FOR SELECTING ANALYSIS APPROACH

- TARGET FACE 5.2 X 4 M
- 4 X 2 M OF FACE UNIFORMLY ILLUMINATED BY BEAM
- THEREFORE:
  - MAJOR VARIATION IN PROTON/NEUTRON SOURCE IN TARGET IS IN DIRECTION OF BEAM
  - DIRECTIONS PERPENDICULAR TO THAT OF BEAM ARE OF INTEREST PRIMARILY TO ASSURE THAT PROTON/NEUTRON LOSS FROM TARGET IS SMALL
- PROBLEM THEREFORE PRIMARILY 1-D, WITH CHECKS ON HOW LARGE NON-SWEPT REGION MUST BE TO MINIMIZE PROTON/NEUTRON LOSS FROM TARGET

# APT

- o FOR PRE-CONCEPTUAL STUDY/DESIGN  
INTERESTED IN FEASIBILITY OF CONCEPT, NOT  
DETAILS
  
- o CONSEQUENTLY APPROACH FOCUSED ON:
  - THREE-DIMENSIONAL REPRESENTATION OF  
TARGET FOR HIGH ENERGY  
PROTONS/NEUTRONS
  
  - FOR LOWER ENERGY NEUTRONS (BELOW  
17MeV):
    - MULTI-STAGE HETEROGENEOUS  
/HOMOGENEOUS DETERMINISTIC  
TRANSPORT ANALYSIS IN 1-D (ANISN)
  
    - EXPLICIT MONTE CARLO ANALYSIS  
PRESERVING IMPORTANT  
CHARACTERISTICS OF PROBLEM, i.e.  
DISCRETE LATTICE AND PRESSURE TUBES  
(MCNP)
  
- o CALCULATIONAL TOOLS NOW AVAILABLE FOR  
PERFORMING DETAILED ANALYSES AND  
OPTIMIZATION STUDIES
  
- o EXPERIMENTS ON PROTOTYPIC LATTICE NEEDED  
TO QUANTIFY UNCERTAINTIES



# APT

## REVIEW OF BNL ANALYSES TO ESTIMATE APT TRITIUM PRODUCTION

- o ENERGIES GREATER THAN 17 MeV
  - HETC RUN FOR FINITE (X,Y,Z),  
HOMOGENEOUS REPRESENTATION OF  
TARGET ACCOUNTING FOR ANY REFLECTORS
  - ENERGY DEPENDENT NEUTRON SOURCE  
AVERAGED OVER ENTIRE TARGET BANKED  
INTO BUGLE-80 GROUP STRUCTURE: S(E)
  - SPACE DEPENDENT NEUTRON SOURCE  
AVERAGED OVER DIRECTIONS  
PERPENDICULAR TO BEAM BANKED INTO  
SLABS: S(X)
  - ALL SUBSEQUENT ANALYSES BASED ON  
ABOVE S(E) AND S(X) SOURCE  
DISTRIBUTIONS

- o ANISN ANALYSES FOR ENERGIES BELOW 17 MeV
  - BUGLE-80 CROSS SECTIONS FOR FLUX DETERMINATION
  - MACKLIB-IV ACTIVATION CROSS SECTION TO DETERMINE TRITIUM PRODUCTION
  - CALCULATIONAL SEQUENCE:
    - (1) CYLINDRICAL GEOMETRY FOR UNIT CELL WITH HETC S(E) IN LEAD RODS
    - (2) FLUX-VOL WGT X-SECTIONS FOR UNIT CELL AND INPUT INTO
    - (3) HOMOGENEOUS SLAB REPRESENTATION OF TARGET WHERE:
      - $S(E,X) = S(E)*S(X)$  FROM HETC
      - $SIG(SLAB) = VF(LATTICE)*SIG(UNIT CELL) + VF(PRESSTUBE)*SIG(S STEEL)$
    - (4) TRITIUM PRODUCTION FROM SLAB TARGET MODIFIED BY HETEROGENEOUS/HOMOGENEOUS FACTOR FROM UNIT CELL CALCULATION

# APT

## Target Lattice Unit Cell

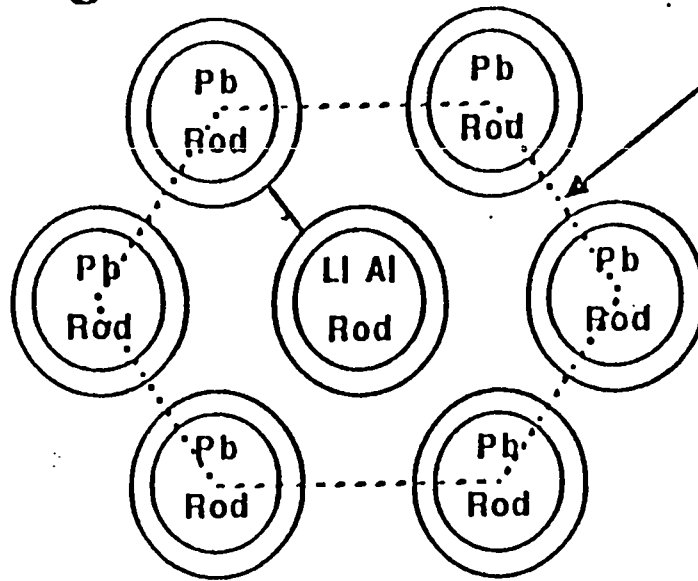

Unit Cell Boundary

Rod O.D. = 1.1 cm  
Aluminum Clad Thickness = 20 mils  
Rod Spacing = 0.1 cm

### ANISN Cylindrical Representation

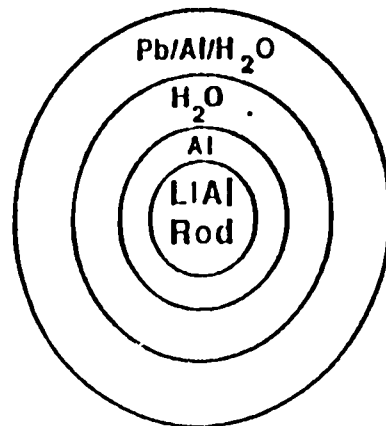

$R_1 = 0.5$  cm  
 $R_2 = 0.5508$  cm  
 $R_3 = 0.6508$  cm  
 $R_4 =$  Equivalent Radius of Cell

Los Alamos - Brookhaven

- o CONFIRMATORY ANALYSES FOR ENERGIES BELOW 17 MeV
  - ANISN AS ABOVE WITH MATXS7 CROSS SECTIONS
  - MCNP (INFINITE IN Y & Z) BUT WITH "EXACT GEOMETRIES"
  
- o ADDITIONAL ANALYSES FOR ENERGIES BELOW 17 MeV WITH MCNP ("EXACT" GEOMETRY BUT INFINITE IN Y)

# APT

## DETERMINATION OF TRITIUM PRODUCTION IN APT TARGET

### o CALCULATIONAL METHODS

- 3-D (HOMOGENEOUS) HETC FOR ENERGIES ABOVE 15-17 MeV
- 1-D (HETEROGENEOUS/HOMOGENEOUS) ANISN OR "3-D EXPLICIT" MCNP FOR ENERGIES BELOW 15-17 MeV

### o CANDIDATE TARGET CONFIGURATIONS CONSIDERED

- CYLINDRICAL AND HEXAGONAL PRESSURE TUBES
- IMPACT OF BE REFLECTORS ON FRONT FACE
- 6:1 AND 2:1 RATIOS OF PB TO LI-AL RODS
- PB PLUS LI-AL RODS (HOMOGENEOUS AND HETEROGENEOUS)

- o MAJOR ASSUMPTIONS IMPACTING ON PRODUCTION ESTIMATES

- 1.6 GeV / 250 MA PROTON BEAM
- PLANT FACTOR 75%
- SRL LI-AL TARGET MATERIAL
- ALL NEUTRONS NOT LOST TO PARASITIC CAPTURE IN LATTICE/REFLECTOR AVAILABLE FOR TRITIUM PRODUCTION

- o CONCLUSION

BASELINE TARGET CONFIGURATION - 2:1  
RATIO OF PB TO LI-AL RODS IN HEX  
PATTERN - CAN PRODUCE 100-103% OF  
DESIRED AMOUNT OF TRITIUM

## MONTE CARLO CALCULATIONS

- o MCNP3B4 (LATTICE CAPABILITY) WITH ENDF/B-V CONTINUOUS ENERGY CROSS SECTIONS
- o FIXED SOURCES BASED ON HETC "HISTOGRAM" S(E) AND S(X) DESCRIBED EARLIER
- o CONFIGURATIONS MODELLED (EXPLICIT GEOMETRY):
  - UNIT CELL (REFLECTING SURFACES)
  - APPROXIMATE SLAB TARGET (INF IN Z; INF IN Y VIA REFL SURFACES), 210 CM DEEP CONSISTING OF UNIT CELLS, WITH 10 CM SOLID BE REFLECTOR ON FRONT FACE
  - APPROXIMATE PRESSURE-TUBE SLAB TARGET (INF IN Y); 7-PRESSURE TUBES DEEP; S(X) CONSTANT IN EACH PT; BE REFLECTOR ON FRONT FACE

# APT

BASE CASE- 1(LI-AL1/21P81  
ROOS, HEX LATTICE

PROBID -  
BASIS:  
1 1.000000, 0.000000, 0.000000  
1 0.000000, 1.000000, 0.000000  
ORIGIN:  
1 0.00, 0.00, 0.00  
EXTENT - 1 2.00, 2.00  
CELL LABELS ARE  
MATERIAL NUMBERS

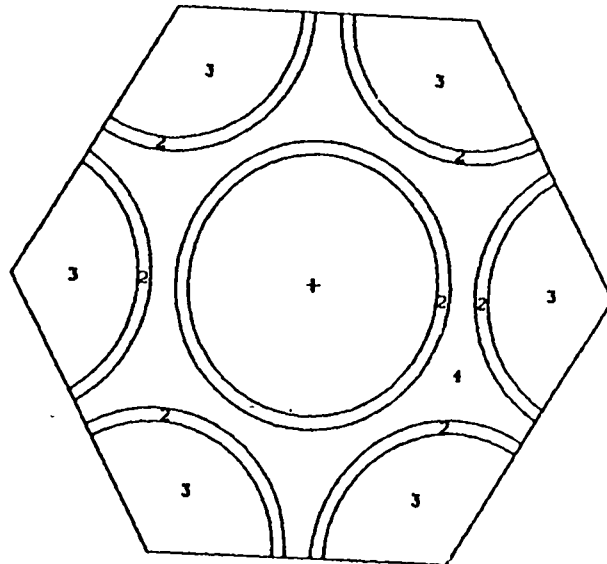

0

Los Alamos - Brookhaven



# APT

BASE CASE - (111-AL)/21PB)  
ROOS, HEX LATTICE

PROBID -  
BASIS:  
| 1.000000, 0.000000, 0.000000|  
| 0.000000, 1.000000, 0.000000|  
ORIGIN:  
| 15.00, 0.00, 0.00|  
EXTENT - | 16.00, 16.00|  
CELL LABELS ARE  
INITIAL NUMBERS

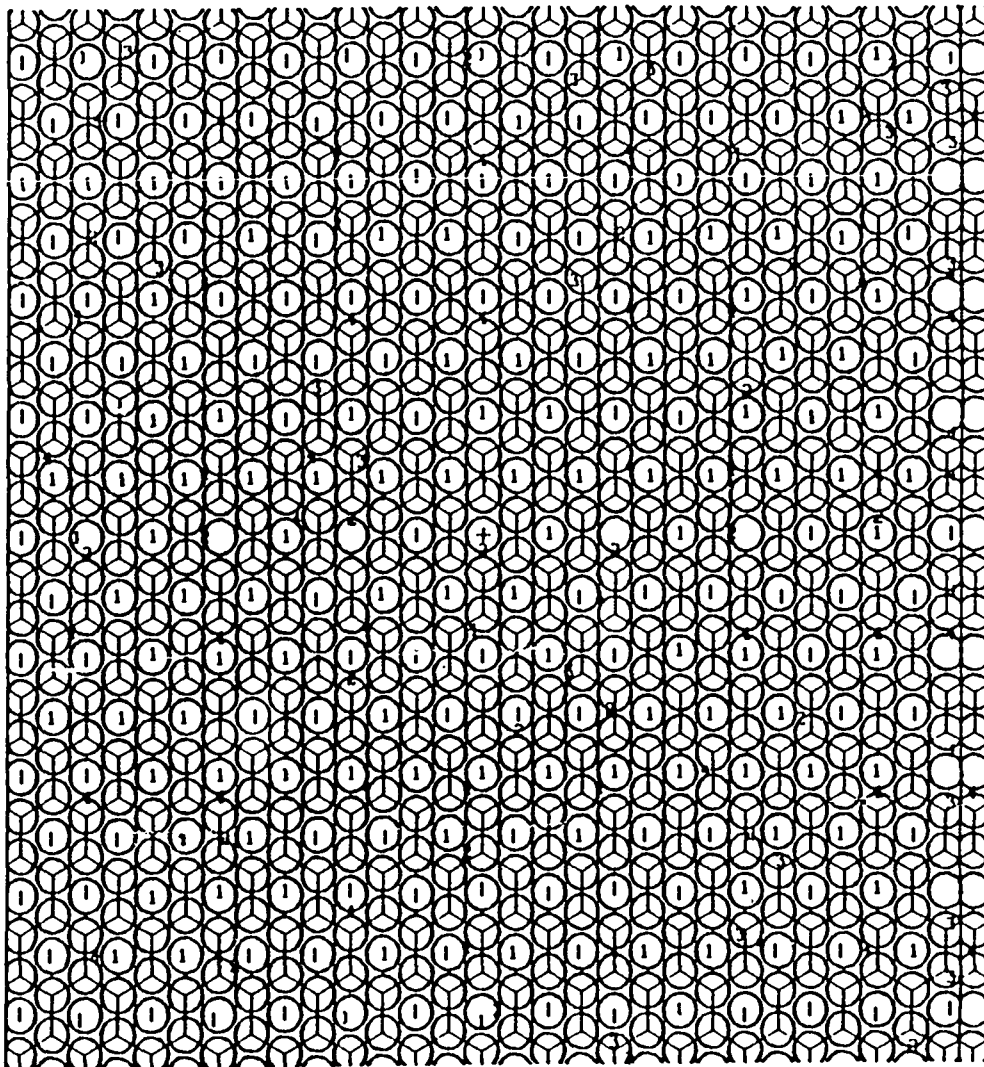

Los Alamos - Brookhaven

# APT

APT- 11L1-FL1/21P8) RODS,  
HEX LATTICE, CYL PRESS TUBES,  
SLAB GEOM  
PROBIO -  
BASIS:  
( 1.000000, 0.000000, 0.000000)  
( 0.000000, 1.000000, 0.000000)  
ORIGIN:  
( 100.00, 0.00, 0.00)  
EXTENT - ( 120.00, 120.00)  
CELL LABELS ARE  
MATERIAL NUMBERS

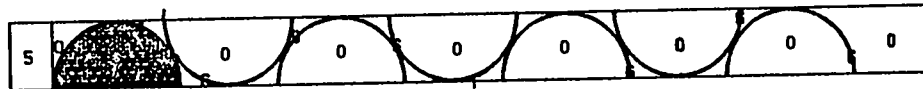

Los Alamos - Brookhaven

# APT

APT- 1(L1-FL)/2(PB) RODS,  
HEX LATTICE, CYL PRESS TUBES,  
SLAB GEOM  
PROB10 -  
BASIS:  
( 1.000000, 0.000000, 0.000000)  
( 0.000000, 1.000000, 0.000000)  
ORIGIN:  
( 15.00, 0.00, 0.00)  
EXTENT - 1 ( 16.00, 16.00)  
CELL LABELS ARE  
MATERIAL NUMBERS

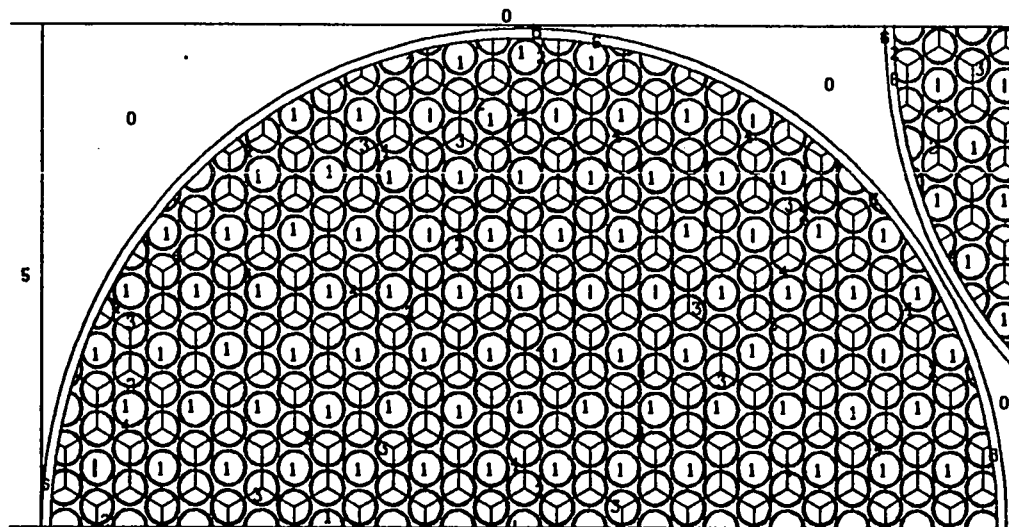

Los Alamos - Brookhaven

# APT

## HETC Predictions (1.5 GeV)

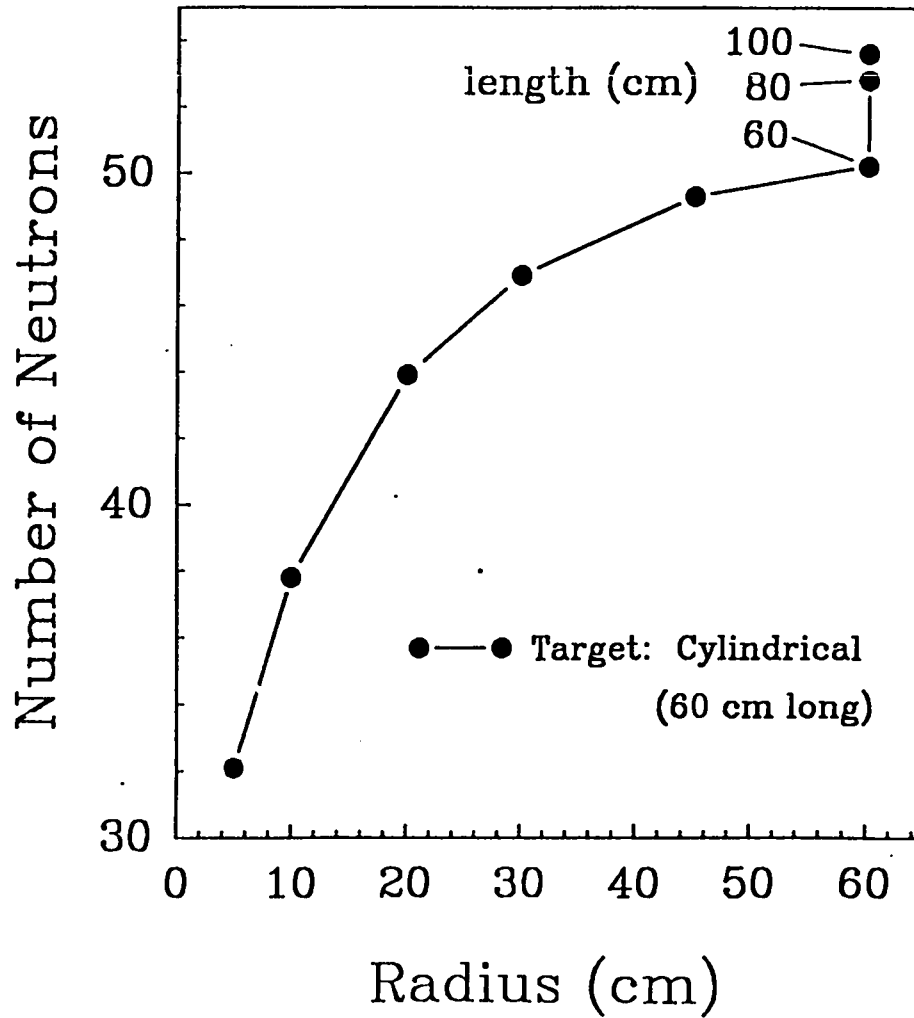

## DATA BASE DEVELOPMENT PROGRAM

---

- DIRECT COUNTER AND FOIL ACTIVATION NEUTRON YIELDS MEASUREMENTS
- SINGLY AND DOUBLY DIFFERENTIAL PRODUCTION RATES  $d\partial/d\Omega$  and  $d^2\partial/d\Omega dE_n$
- PROTON ENERGIES OF  $E_p = 200, 800, 1200,$  and  $1500$  MeV
- ANGULAR DISTRIBUTIONS OF  $\Theta_n = 12, 30, 45, 90,$  and  $135^\circ$
- NEUTRON SPECTRAL RANGE  $E_n = 0.1 - 200$  MeV
- RANGE THICK AND THIN TARGETS OF Li, H<sub>2</sub>O, Al, Fe, and Pb
- PSD AND NTOF NEUTRON DETECTION TECHNIQUES FOR DIRECT COUNTER EXPERIMENTS

## LATTICE YIELD DEMONSTRATION

---

- DEMONSTRATE UTILITY OF DESIGN AND MODEL CORRELATION BY MEASURING TRITIUM YIELD
- MEASURE NEUTRON DISTRIBUTION
- MEASURE NEUTRON LEAKAGE RATES
- MEASURE ACTIVATION PRODUCTS AND YIELDS
- MEASURE PROMPT AND DECAY HEAT DISTRIBUTIONS

# TRITIUM RECOVERY

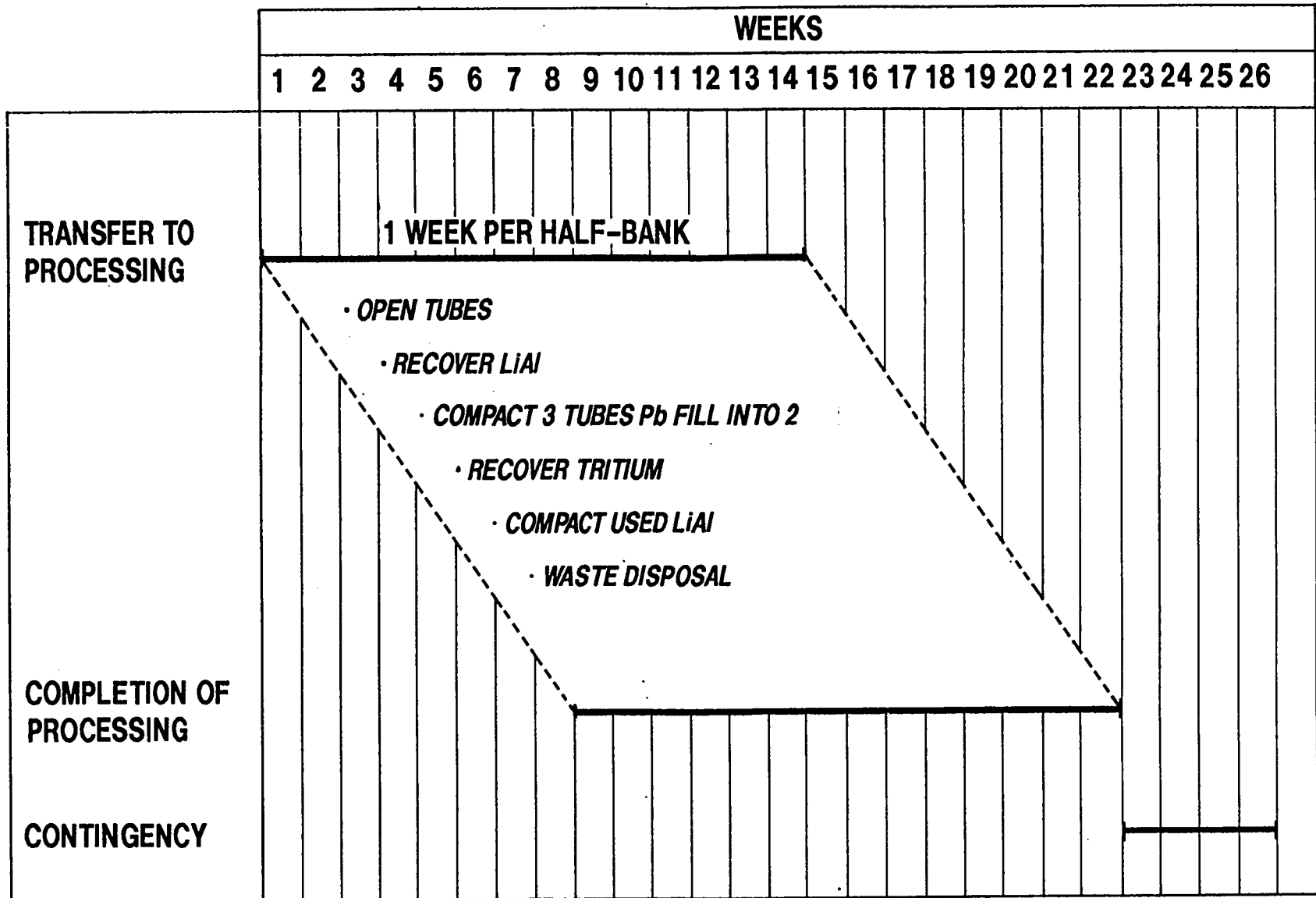

## APT Target Protection System (TPS)

- Beam Trip System
  - Turns Off Beam Quickly If Off-Normal Conditions Detected
  - Beam Monitor System (BMS) Detects Changes in Beam (Focus)
  - Target Monitoring System (TMS) Detects Target Cooling Changes
    - .. Thermistors in Target Heat Up if Cooling Degrades (Voiding)
    - .. Coolant Flows, Pressures, Temps Monitored for Changes
- Target Auxiliary Cooling System (Makes Sure Beam Tripped 1st)
  - Closes Isolation Valves If Pressure Drop or Loss of Heat Sink, As Detected by TMS
  - Target Auxiliary Cooling System (TACS) Removes After-Heat
    - .. Natural Circ TACS Cooling Loop Always On, Sized for After-Heat
    - .. TACS Water Tank Supplies Water for Loss of Coolant Events



## Change in Pumping Events

- Detection:
  - Target Monitoring System (TMS)
    - .. Pump Speed Should Be Monitored Directly (Fast)
    - .. Changes in Flow or Pressure Also Detected Quickly
    - .. Changes In Temperatures or Target Conditions - Slowly
- Cooling Mode: Natural Circulation Via Normal and Auxiliary Loops
- Analysis: How Much Time Before Beam Must Be Tripped ?
  - If Both Pumps Trip and Coast Down
  - If One Pump Seizes and Other Continues Pumping  
*(substantial subcooling makes pump cavitation unlikely)*
- Conclusions: (Assuming Peaking of 2.0)
  - If Both Pumps Coasting Down: 13 Seconds (No Problem)
  - If One Pump Seizes: Approx 20 Seconds (No Problem)

## Reduced Pumping Events Flows to First Row Tubes and Peak Lead Temperatures

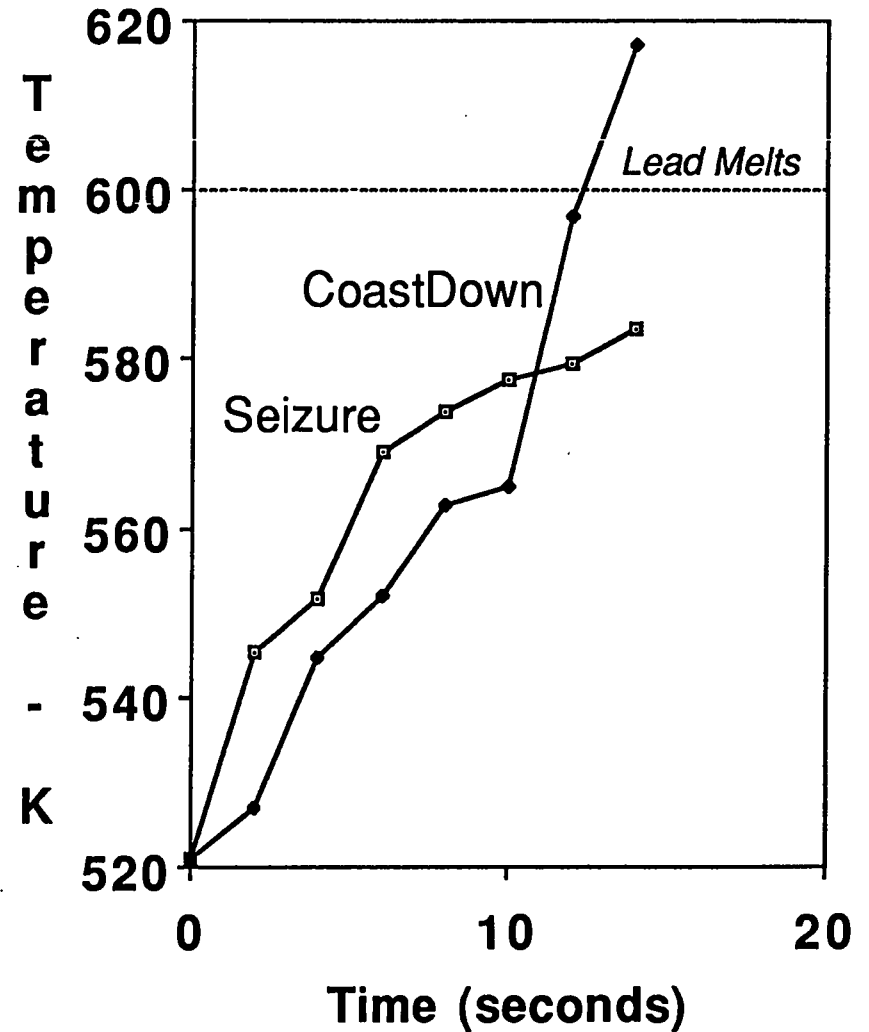
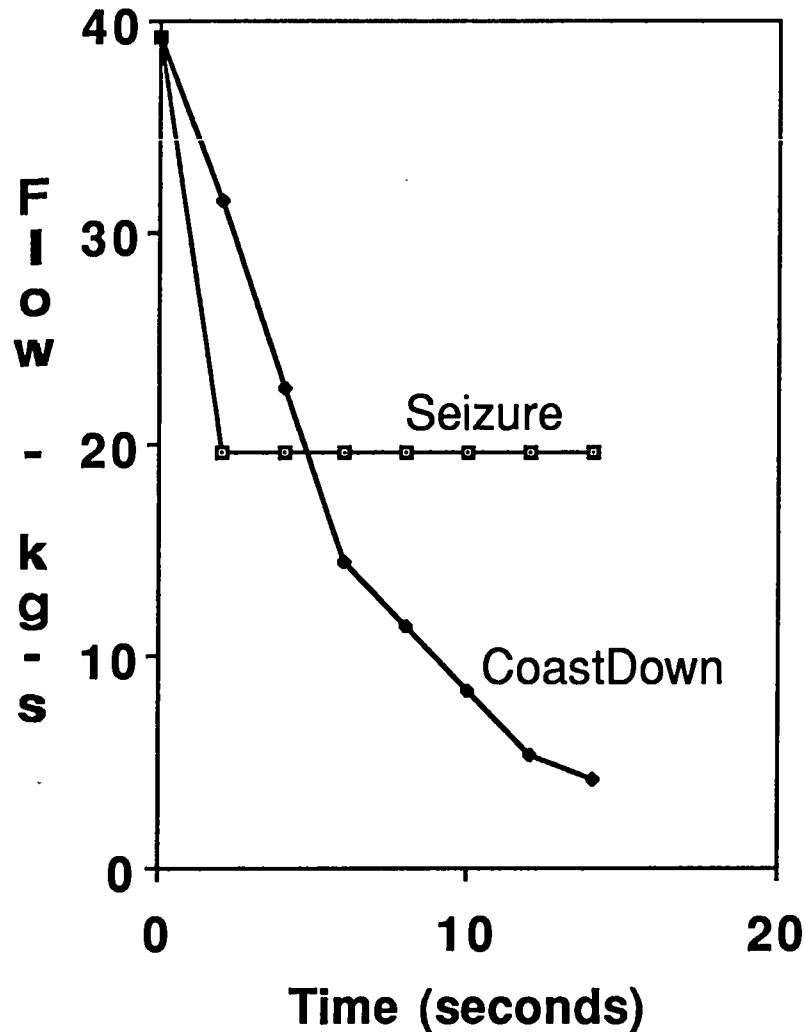

### Conclusions:

- 1) CoastDown of Both Pumps Is the Greater Concern (Faster+More Likely)
- 2) In Either Case, Have 12 Seconds to Trip Beam (More Than Sufficient)

## Flow Blockage Events

*Note: Try To Preclude By Design, Using Wire Mesh Screens In Headers To Stop Any Loose Materials From Reaching Pressure Tube Inlets*

- Detection:

- Target Monitoring System (TMS)

- .. Change In Local Cooling Noted By In-Target Thermistors

- .. Changes in Loop Coolant Conditions Both Mild and Slow

- (Therefore Slow to Detect Outside Target)*

- Cooling Mode: Counter-Current Flow in Blocked Tube Probably Sufficient If Beam Is Off

- Analysis: Complex, To Be Completed As Design Matures

- Conclusions: Potentially A Problem Area, But Likelihood Of a Blockage Can Be Reduced To Near-Zero By Design

## Loss of Coolant Events

- Detection:
  - Target Monitoring System (TMS)
    - .. Changes In Flow or Pressure Detected Quickly
    - .. Changes in Local Cooling Noted By Thermistors
  - Steam In Vacuum Chamber Will Reduce Beam Intensity
- Cooling Mode: (Assume Isolation Valves & Door Closed)
  - TACS Water Tank: Add Make-Up & Condense Steam (via valve)
    - .. Water Added To Inlet Headers Once Pressure Drops
    - .. Water Added To Outlet Headers If Flow Reverses Into Target
    - .. Sufficient Water For Decay Heat (Essentially Infinite)
  - Large Break Will Result In Flooded Cavity (Above Inlet Headers)
- Analysis: Back-of-Envelope Indicates Small Water Inventory Needed
  - 1500 Gallons Lasts Many Hours
  - 25000 Gallons Would Flood Cavity to 70%
- Conclusions: Once Beam Is Off, Simply Need Sufficient Water

## Loss of Heat Sink Events

- Detection:
  - Target Monitoring System (TMS)
    - .. Detects Slow Increases In Temperature of Coolant Water
    - .. In-Target Thermistors Would Eventually Detect
- Cooling Mode: Once Beam Is Off, TACS Cooling Loop Sufficient  
Alternate Mode: Feed and Bleed Using TACS Water Tank
- Analysis: Simply Have To Design TACS Cooling Loop With  
Sufficient Heat Transfer Area and Coolant Flow Area  
Alternate Mode: Plenty of TACS Water Available
- Conclusions: Having Two Back-Up Modes of Cooling Available (Both  
Based on Natural Circulation) Makes This Event Non-Threatening

## Inadvertent Closure of Isolation Valves

- Detection:
  - Target Monitoring System Will Detect Quickly and Stop Beam
- Cooling Mode: Once Beam Is Off, TACS Cooling Loop Sufficient
  - Alternate Mode: Feed and Bleed Using TACS Water Tank
- Analysis: Assure TACS Design Provides Sufficient Heat Removal
- Conclusions: A Variation on Loss-of-Heat Sink Event.

## Inadvertent Opening of Valve To/From TACS Tank

- Detection:
  - Target Monitoring System Will Detect Quickly and Stop Beam
- Cooling Mode
  - If Safety/Relief Valve Open, TACS Water Tank Pressure Will Equalize with Pressurizer and Normal Cooling System Will Operate At Reduced Pressure *(Note: Must Assure TACS Tank Nearly Full)*
  - If Lines from TACS Tank Open, Transient Could Be More Complex, But Cooling Of Target Should Be Sufficient In All Cases
- Analysis: As Design Matures, Analyze Event Developments In Greater Detail To Assure Valve Set-Points Do Not Create Any Problems
- Conclusions: Results In Target Cooling At Lower Pressure, But Transition Should Be Considered In Greater Detail As Design Matures

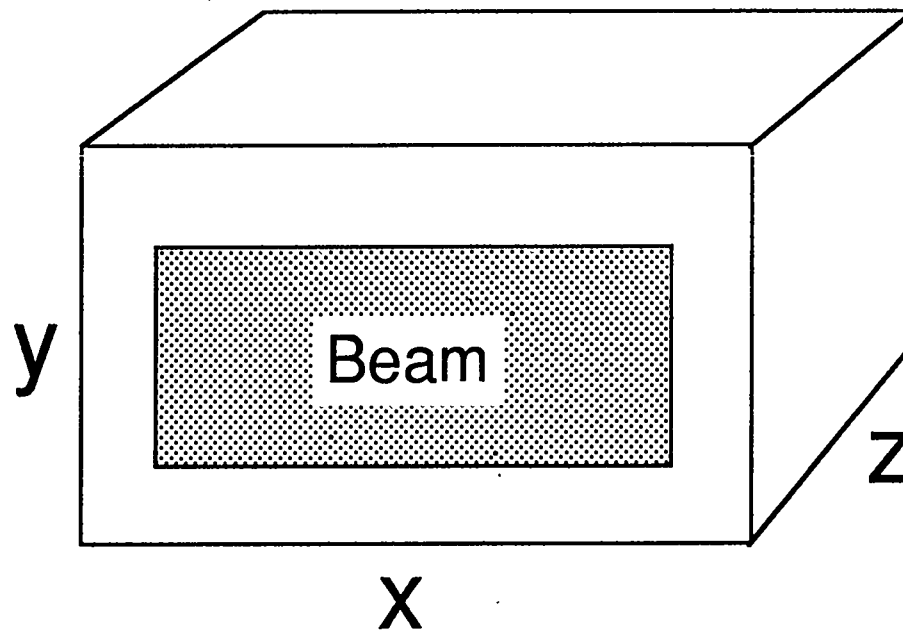

## Peaking Considerations:

- x- Prefer Flat so all tubes experience same heating (assume 1.2)
- y- Some Peaking Acceptable along coolant channel
- z- Energy Deposition Uncontrollable, Orifice coolant channels



***APT***

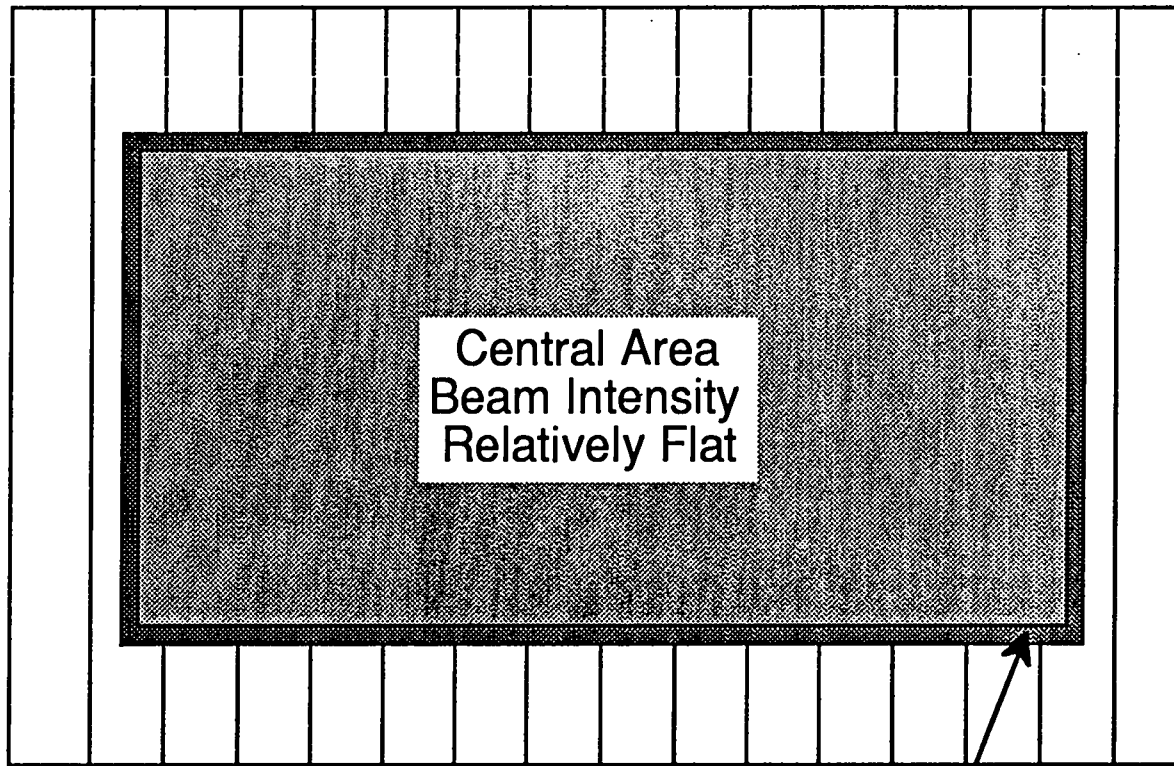

Perimeter Peaking Approximately 2.0

**Beam Focus on First Row of Pressure Tubes in Target Lattice**

**APT**

## Impact of Across-Face Beam Peaking on Hottest Pressure Tube Temperatures

- For Up-Face (y) Direction, Assume Linear Beam Profile  
(not Crucial Unless Severely Peaked)
- For Into-Target (z) Direction, Assume 38 % Energy Deposition  
in First Row of Pressure Tubes
- Assume 27% Flow to First Row Pressure Tubes (Orificing)
- Vary Beam Peaking Factor Across Face of Target from 1.0 to 3.0
  - Peaking Factors Around 1.5 May Be Practical
  - Peaking Factors Below 2.0 Should Be Assured

## Peak Temperatures in Hottest Pressure Tube vs. Beam Peaking

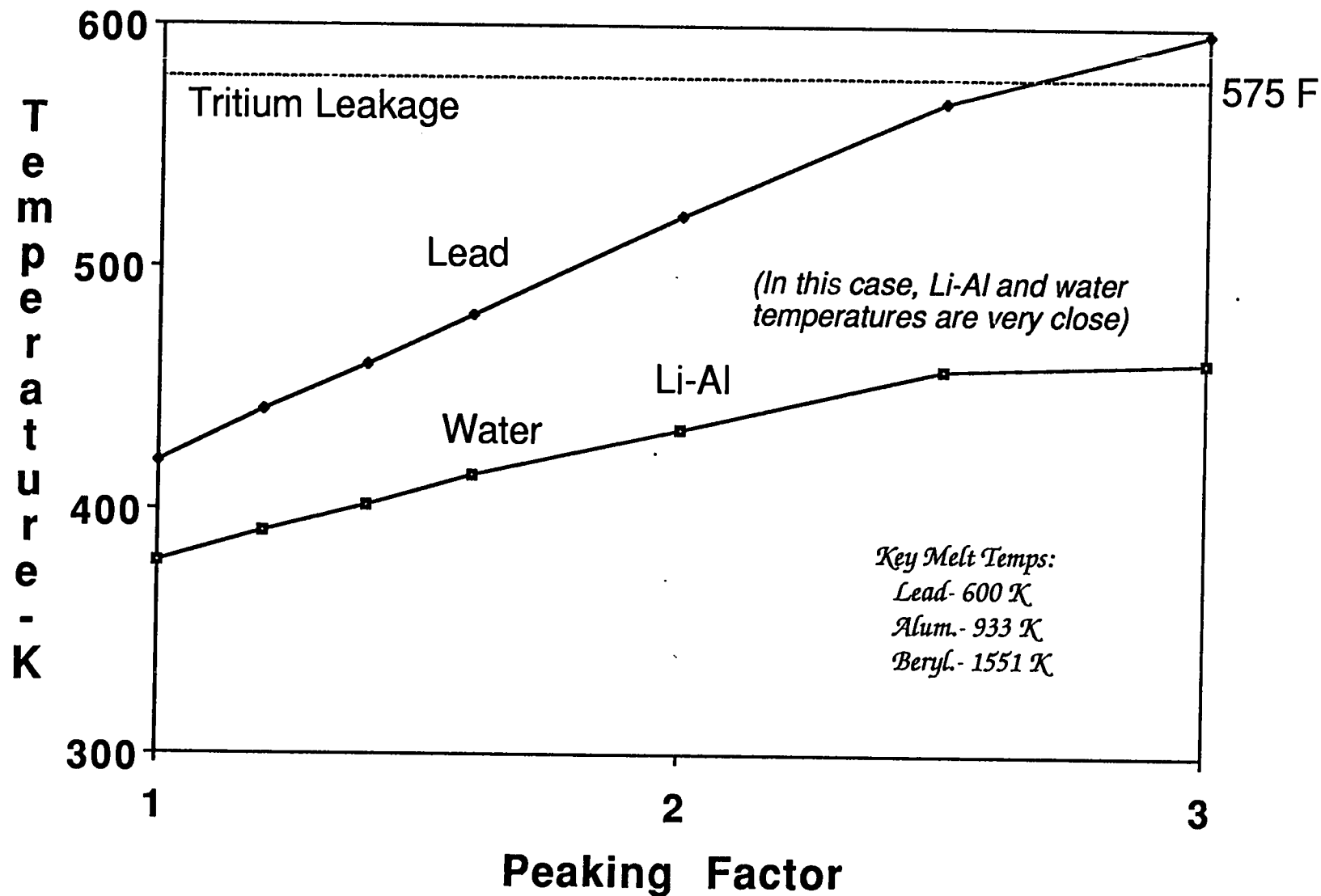

## RAMI Expectations (Target System)

- Reliability: Controlled By Beam Availability, Assuming That:
  - Back-Up Pumping Is Provided (Only Active Component)
  - Target Protection System Does Not Generate Spurious Trips
- Availability: Like Reliability, Except For Target Re-Load Factors
- Maintainability: No Apparent Problems
  - Section Within Vacuum Chamber: No Maintenance Needed
  - Section Outside Vacuum Chamber: Accessible
- Inspectability: Same as Reliability, Although Provision for  
Remote Inspection of Target and Vacuum Chamber is Feasible