

LA-6666-MS

Informal Report

c.3

UC-80

Issued: January 1977

See attached
Errata Sheet

Research on Plasma Core Reactors

by

G. A. Jarvis
D. M. Barton
H. H. Helmick
William Bernard
R. H. White

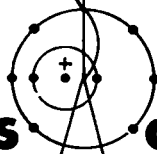

los alamos
scientific laboratory

of the University of California

LOS ALAMOS, NEW MEXICO 87545



An Affirmative Action/Equal Opportunity Employer

This work supported by the Research Division, Office of Aeronautics
and Space Technology, National Aeronautics and Space Administration
NASA Contract W13755.

Printed in the United States of America. Available from
National Technical Information Service
U.S. Department of Commerce
5285 Port Royal Road
Springfield, VA 22161
Price: Printed Copy \$3.50 Microfiche \$3.00

This report was prepared as an account of work sponsored
by the United States Government. Neither the United States
nor the United States Energy Research and Development Ad-
ministration, nor any of their employees, nor any of their con-
tractors, subcontractors, or their employees, makes any
warranty, express or implied, or assumes any legal liability or
responsibility for the accuracy, completeness, or usefulness of
any information, apparatus, product, or process disclosed, or
represents that its use would not infringe privately owned
rights.

UNIVERSITY OF CALIFORNIA
LOS ALAMOS SCIENTIFIC LABORATORY
(CONTRACT W-7405-ENG-36)
P. O. Box 1663
LOS ALAMOS, NEW MEXICO 87544

IN REPLY
REFER TO:
MAIL STOP:

To: Holders of LA-6666-MS

Please make the following correction on page 2.

Core Number 2, paragraph 3, line 8. Change "containment"
to "contaminant"



RESEARCH ON PLASMA CORE REACTORS

by

G. A. Jarvis, D. M. Barton, H. H. Helmick,
William Bernard, and R. H. White

ABSTRACT

Experiments and theoretical studies are being conducted for NASA on critical assemblies with 1-m-diam by 1-m-long low-density cores surrounded by a thick beryllium reflector. These assemblies make extensive use of existing nuclear propulsion reactor components, facilities, and instrumentation. Due to excessive porosity in the reflector, the initial critical mass was 19 kg U(93.2). Addition of a 17-cm-thick by 89-cm-diam beryllium flux trap in the cavity reduced the critical mass to 7 kg when all the uranium was in the zone just outside the flux trap. A mockup aluminum UF₆ container was placed inside the flux trap and fueled with uranium-graphite elements. Fission distributions and reactivity worths of fuel and structural materials were measured. Finally, an 85 000-cm³ aluminum canister in the central region was fueled with UF₆ gas and fission density distributions determined. These results will be used to guide the design of a prototype plasma core reactor which will test energy removal by optical radiation.



Introduction

T. S. Latham and collaborators¹ at the United Technologies Research Center (UTRC) have recently suggested several attractive applications of cavity reactor systems aimed at meeting future critical energy needs. Uranium fuel in gaseous or plasma form permits operation at much higher temperatures than possible with conventional solid fueled nuclear reactors. Higher working fluid temperatures in general imply higher thermodynamic cycle efficiencies, which lead to proposals for advanced closed-cycle gas turbine driven electric generators and MHD power conversion systems for electricity production. Cycle efficiencies ranging from 50 to 65% are calculated for these systems.

Further, the possibility of energy extraction in the form of electromagnetic radiation allows consideration of many photochemical or thermochemical processes such as dissociation of hydrogeneous materials to produce hydrogen. Lasers may be energized either by direct fission fragment energy deposition in uranium hexafluoride (UF₆) and lasing gas mixtures or by optical pumping with thermal or nonequilibrium electromagnetic radiation flowing out of the reactor.

The Los Alamos Scientific Laboratory (LASL) has a modest program to acquire experimental and theoretical information needed for the design of a prototype plasma core reactor which will test heat removal by optical radiation. Experiments are be-

ing conducted on a succession of critical assemblies with large low-density cores surrounded by a thick moderating reflector. Static assemblies, first with solid fuel, then with UF₆ in containers, will be followed by others with flow UF₆.

Plasma Core Assembly (PCA) Design

In the first quarter of 1974, a joint working group formed by NASA from LASL and UTRC personnel produced an engineering feasibility design study revealing the possibility of constructing a large beryllium reflected cavity reactor from existing nuclear propulsion program materials and control components.²

Reactor Component Availability

Substantial quantities of beryllium reflector parts were stored at Los Alamos and the Nevada Reactor Development Station after the termination of the nuclear propulsion program. Beryllium reflector assemblies from 11 Rover/NERVA reactors, representing an original cost of approximately \$5 million, were transferred to Los Alamos. Also, four additional beryllium reflector assemblies, including a set of 18 stepping-motor driven control drum actuators, were available at Los Alamos.

LASL Facilities

The facilities of the LASL Critical Experiments Group include three remotely controlled critical assembly laboratories, called Kivas, equipped with a variety of

critical assembly machines of varying complexity. A central control building houses control rooms, offices, and laboratory space. Parts of these facilities are available for the initial phases of the plasma core reactor project.

The cavity-type assemblies will be on the "Mars" critical assembly machine (Fig. 1) located in Kiva 1. This machine was built early in the Rover program and was used for neutronic and core optimization studies for the Kiwi, Phoebus, and Nuclear Furnace reactors. Early beryllium-reflected cavity reactor experiments were also performed on this machine.^{3,4} Figure 1 shows the Mars machine with a Phoebus II reflector installed. The overall size is similar to that of the planned cavity assemblies. Some of the 18 control drum actuators are visible above the reflector.

1. A framework that includes a base plate for supporting the reflector, an upper platform for mounting the existing control drums, and a personnel platform.

2. Provision for removing a fueled core from the reflector. The core is supported on the platen of a hydraulic cylinder, which is centered beneath the reflector and can be retracted as a safety device.

3. Provision for removing the core from beneath the machine. The lowered core assembly rests on a cart that may be rolled out on guide rails from beneath the reflector to provide easy access for alterations to the core.

Reflector Design

The critical assembly reflector design makes use of beryllium from most of the Rover reactor types. Figure 2 shows reflector parts from several of the Rover reactors assembled to form a cross section of the cylindrical reflector wall. Figure 3 identifies major Rover beryllium components by location. The end plugs of Nuclear Furnace, Pewee, and Honeycomb reflector pieces, shown in Figs. 2 and 3, consist of beryllium that averages 90% of normal density. Graphite fillers, 38 mm thick separate these from 190-mm-thick NRX and Kiwi B sectors of beryllium also at 90% normal density. A succeeding graphite annulus 44 mm thick is followed by a 203-mm-thick Phoebus II assembly which contains 18 control drums and is beryllium at 87.5% normal density.

All of the Rover beryllium reflector components have holes in them required for coolant flow, tie rod access, instrumentation lead channels, reflector density adjustment, and control drum containment. These lead to loss of neutrons by streaming and result in increased critical mass if left unfilled. Calculations indicate a reactivity loss of about 0.25\$ for each percent reduction in the density of the Be reflector.

Figure 4 shows the calculated penalty for substituting a 50-mm annular zone of graphite for beryllium as a function of the location of the graphite in the reflector. In the outer two-thirds of the reflector, high-purity graphite is a good substitute for beryllium but is of little help in the inner region. The reflector encloses a 1.02-m-diam by 1.05-m-high cavity in which the various solid and gaseous uranium fuel cores will be studied.

Experimental Program

Core Number 1

A homogeneous uranium distribution in the cavity, simulated by use of uranium metal foils laid on a set of ten equally spaced aluminum discs, Fig. 5, had a critical mass of 19 kg U(93.2). The reactivity swing for the 18 control drums was 6.1\$. Figure 6 gives the control drum calibration curve. Measured reactivity worths of core materials are uranium 0.73\$/kg, aluminum -0.03\$/kg, and graphite 0.025\$/kg.

Core Number 2

An early goal for the Plasma Core Assembly was to operate with a central zone of UF₆ gas surrounded by a zone of solid uranium fuel. To mock up this situation core number 2 consisted of uranium metal foil attached to a 0.94-m-diam thin-walled aluminum cylinder, Fig. 7, centered within the cavity. A critical mass similar to that for core 1 was indicated by subcritical comparison.

The critical mass of about 19 kg is more than a factor of two higher than calculated for uniformly distributed fuel in an idealized reflector, indicating undermoderation in the reflector and/or contaminants having high thermal neutron absorption cross sections in the beryllium and graphite. Neutron leakage through the large number of small straight coolant channels in the beryllium also tends to increase the critical mass value.

The beryllium specification limited the iron content to less than 0.18% by weight. One-dimensional criticality calculations showed that this amount of iron would increase the critical mass by about 9%. Two-dimensional criticality calculations indicated that two hundred parts per million boron contaminant in the graphite would account for the excess critical mass if boron alone were the cause. The large critical mass is believed to be due to a combination of the effects discussed above.

Core Number 3

The simplest solution to the neutron undermoderation problem was to add a zone of beryllium to the cavity. A suitable beryllium annulus 0.55 m i.d. by 0.89 m

o.d. by 1.04 m high, Fig. 8, was formed from Pewee and Honeycomb parts. This structure had a mean density 85% that for normal beryllium and was surrounded by a 0.94-m-diam aluminum cylinder to support uranium metal foil. The initial critical mass with all uranium in the outer fuel zone was 6.84 kg U(93.2).

The reactivity worth of the control drums is influenced by the amount of uranium in the core. Since core number 3 with its added inner beryllium zone sharply reduced the critical uranium loading, the control drums were recalibrated, using positive period measurements. The reactivity swing for one control drum is 0.224\$, giving 4.03\$ for the 18 control drums. Figure 9 gives the calibration curve for the entire 18 control drums. The control drum worth is now only two-thirds that for the empty cavity configuration of cores one and two, but is considered adequate for the planned experiments.

Table I lists the reactivity worths of uranium, aluminum, and carbon for indicated positions in core number 3.

It should be noted that the uranium worth values of Table I imply an appreciably greater fission density in the central zone than in the outer fuel zone. The additional neutron moderation in the flux trap results in a central zone uranium reactivity worth six times that for uranium in the outer zone. As the fission density in a highly thermalized system varies as the square root of the reactivity, UF_6 in the central zone will benefit from a fission density enhancement of about 2.4 over that for uranium in the driver zone.

The effects of flux trapping by an additional beryllium zone within a cavity surrounded by an undermoderating reflector was examined using one-dimensional neutron transport calculations on an equivalent spherical mockup of the PCA cylindrical geometry. The calculated fission density in the central zone was 2.3 times that for the outer or driver fuel zone.

Core Number 4

Core number 4 uses the beryllium flux trap of core 3 and uranium-graphite Rover fuel elements in the outer driver zone, Fig. 10. The inner experimental zone is provided with a mockup of an aluminum UF_6 container to be used in later experiments. Low-density uranium-graphite fuel elements are used in this region to simulate UF_6 loadings.

Table II gives the loading specifications for the uranium-graphite fuel elements.

Figure 11 shows the available fuel element holes in the driver and experimental zones. Figure 12 shows core No. 4 positioned to be raised into the PCA reflector.

Material Reactivity Evaluations

Reactivities for uranium and other materials were measured in the central experimental and driver zones. Results agreed with those found for core 3.

As seen in Table I, uranium has a much higher reactivity worth in the inner zone

TABLE I
REACTIVITY WORTHS OF MATERIALS IN PCA CORE NO. 3.

| <u>Material</u> | <u>Material location</u> | <u>Worth in \$/kg</u> |
|-----------------|--------------------------|-----------------------|
| U (93.5%) | On axis | + 33.50 |
| U (93.5%) | Near end of Al support | + 5.54 |
| Al | On axis | - 0.108 |
| Al | At Al support | - 0.030 |
| Honeycomb C | On axis | - 0.014 |
| PCA Reflector C | On axis | - 0.032 |

TABLE II

| <u>Element Location</u> | <u>Uranium Density</u> | <u>Uranium/Element</u> |
|-------------------------|--------------------------|------------------------|
| Driver zone | 400 mg U/cm ³ | 82.8 g |
| Experimental zone | 100 mg U/cm ³ | 20.7 g |

than in the outer or driver zone, so that the critical mass will decrease as uranium is added to the central region of the core. Figure 13 shows the measured variation of critical mass with the fraction of fuel in the inner zone.

Fission Density Measurements

Fission density distributions were determined for two different core loadings for the experimental and driver fuel zones by beta scanning U-loaded Al wires irradiated in the central holes of selected fuel elements. Figure 14 shows the fuel element configuration and wire locations. Figure 15 shows the core mid-plane radial fission distribution. The fission density rises slowly from the center outwards. The ratio of the central element to driver element fission density values is 2.40, in good agreement with the value of 2.4 noted in section III-c which was determined from uranium reactivity measurements. Figure 16 gives fission distributions for two central fuel zone axial positions.

Core Number 5

UF₆ gas was used as the fuel for this core in the inner zone using the UTRC double-walled canister and gas handling system. A Be flux trap separated the gas from a driver fuel element zone composed of lightly loaded uranium-graphite fuel rods described in the previous section. Figure 17 is a photograph showing the canister mounted on a ram underneath the reflector ready for assembly. Two pie sections of the lower Be end plug have been removed to show the flex lines that connect the canister to the gas handling system in the foreground.

Figure 18 is a schematic of the gas handling system. ²³⁵UF₆ in the supply bottle is a solid at room temperature. This bottle is immersed in a hot water bath and heated for one hour at about boiling temperature (88°C). This converts the solid to a gas and by suitable valving, a known amount of the gas is trapped in the transfer bottle of the same manifold. Verification of the amount of gas in the transfer bottle is obtained by weighing the bottle and container. The entire gas system and

canister are next heated to about 66°C using heat tapes and hot flowing He gas. This requires about three hours. The UF₆ now remains in the gas phase for critical operations.

Recovery of the UF₆ is accomplished by pumping down the canister and gas system through a glass liquid nitrogen (LN) trap. Material recovery is evaluated by weighing the glass trap and contents. After completing the recovery cycle, we find very little residue in the canister, as affirmed by running the reactor at delayed critical. However, weighing showed that some UF₆ remained in the transfer system. We suspect that the majority of this material is in the corrugated flex lines linking the gas system to the canister. Table III shows the results obtained from two transfer operations.

UF₆ Reactivity Evaluation

A lightly loaded Kiwi fuel element was placed in the region between the canister and the Be flux trap in order to reevaluate the reactivity worth of uranium in the central region. A value of 0.0295\$/g U was obtained which translates to 0.0199\$/g UF₆. An initial operational limit on 1\$ for the gas in the core restricts the UF₆ to a minimum of 50 g.

Three fission density distributions were measured in the gas core along paths as indicated in Figure 19. U-loaded Al wires were placed on the central axis and on a parallel line displaced 10 cm radially from this axis. Another wire was on a diameter at the mid-plane of the core. The wires were irradiated for 10 minutes at a power level of about 70 watts and then scanned with a beta counter to obtain the data plotted in Figure 20. We found similar distributions for the two core loadings of 12 to 24 grams of UF₆. The radial traverse, shown, is flat to within 0.1%, as expected for such a light uranium loading. An earlier experiment noted in section III-c, using 393 grams of uranium in a solid uranium-graphite fuel mock-up of the gas core, had a 3% rise in fission density from the center to the core edge, indicating a slight uranium self-shielding effect. The axial fission density

TABLE III

SUMMARY OF DELAYED CRITICAL RUNS ON PCA

| | UF ₆ Gas Transferred (g) | Reactivity Change (\$) | UF ₆ Recovered (g) | UF ₆ left in canister (g) | UF ₆ left in lines (g) |
|-------|---|------------------------------|-------------------------------------|--|---|
| Run 1 | 12.0 | 0.20 | 3.6 | 2.2 | 6.2 |
| Run 2 | 24.6 | 0.50 | 14.9 | 2.5 | 7.2 |

falls off about 8% from the mid-plane to the core end. This results from holes in the reflector end walls for plumbing and thinner beryllium in this region.

Concluding Remarks

A beryllium reflected critical assembly has been constructed which is suitable for performing tests on static and flowing UF_6 cores and ultimately on advanced models employing hydrodynamical containment of the UF_6 by a flowing buffer gas. Dividing the core into a driver zone containing a major fraction of the fuel in solid form separated by a neutron flux trap from a central experimental zone for gaseous fuel has several advantages:

1. The fission density in the gas fueled region is boosted by a factor of 2.4 over that in the driver zone.

2. An ideal gas core geometry with length about three times the diameter is available.

3. Initial evaluation of reactor safety problems for the flowing UF_6 gas systems may readily be studied since only a small fraction of the total uranium will be in gaseous form. UF_6 gas pressures are not restricted to the narrow range of values required to make an all- UF_6 -fueled core critical.

References

1. T. S. Latham, F. R. Biancardi, and R. J. Rodgers, "Applications of Plasma Core Reactors to Terrestrial Energy Systems," AIAA paper 74-1074, AIAA/SAE 10th Propulsion Conf., San Diego, CA, October 21-23, 1974.
2. H. H. Helmick, G. A. Jarvis, J. S. Kendall, and T. S. Latham, "Preliminary Study of Plasma Nuclear Reactor Feasibility," Los Alamos Scientific Laboratory report LA-5679, July 1974.
3. G. A. Jarvis and C. C. Byers, "Critical Mass Measurements for Various Fuel Configurations in the LASL D_2O Reflected Cavity Reactor," AIAA paper 65-555, AIAA Propulsion Joint Specialist Conf., June 1965.
4. H. C. Paxton, G. A. Jarvis, and C. C. Byers, "Reflector-Moderated Critical Assemblies," Los Alamos Scientific Laboratory report LA-5963, July 1975.

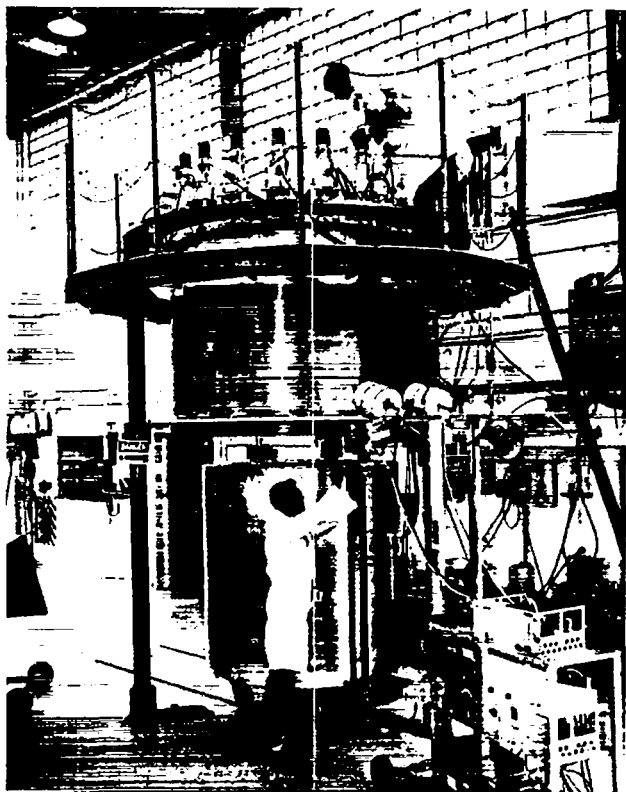

Fig. 1 Mars Machine with Phoebus II Rover Assembly.

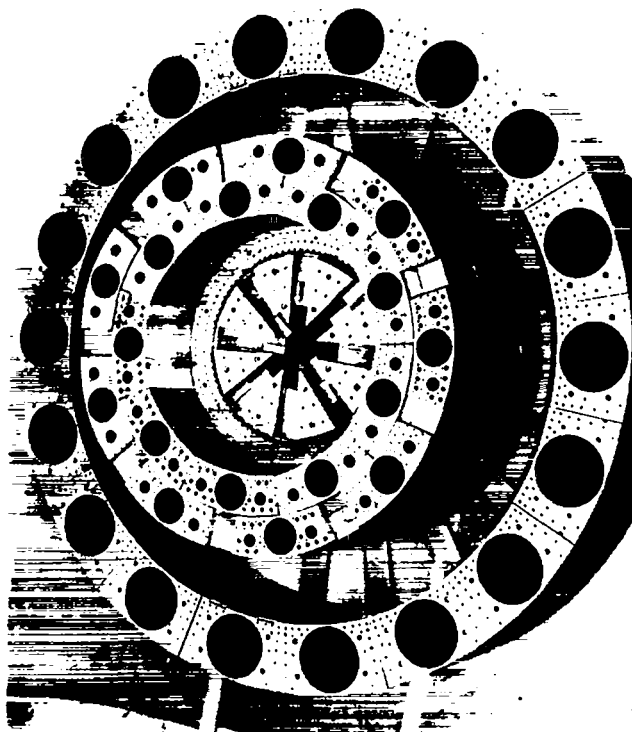

Fig. 2 Rover Beryllium Reflector Components Used in PCA.

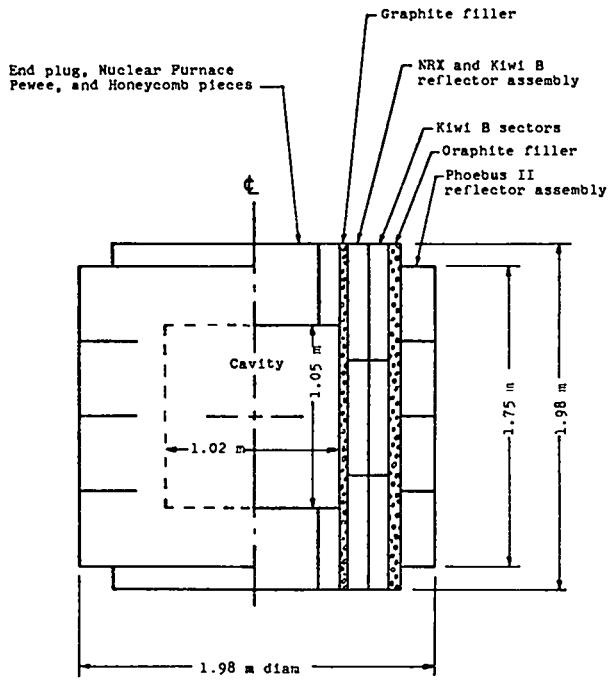

Fig. 3 PCA Reflector.

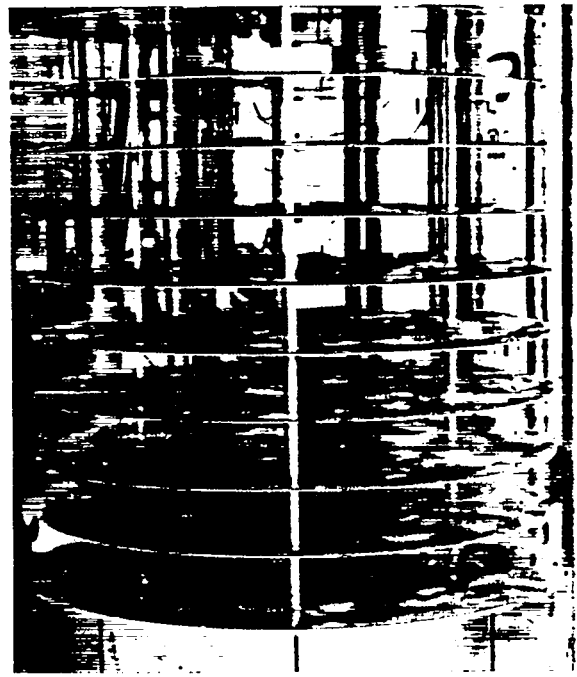

Fig. 5 Core Number 1.

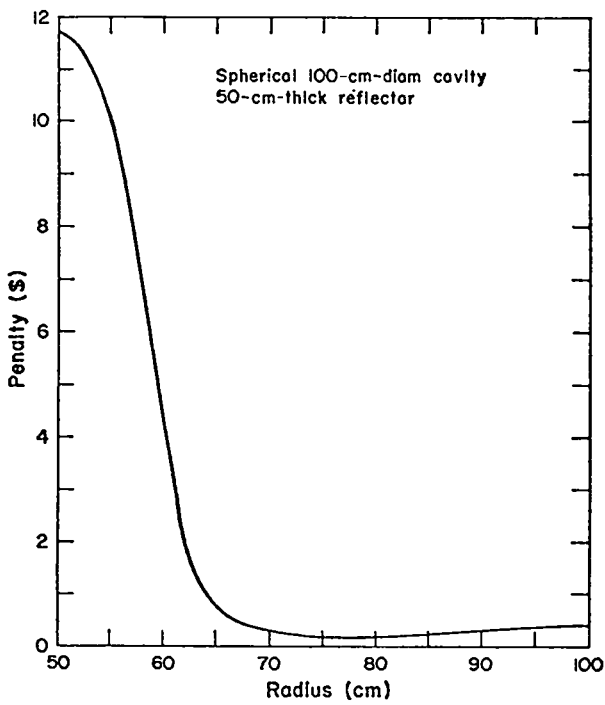

Fig. 4 Reactivity Loss with Substitution of Graphite for Beryllium.

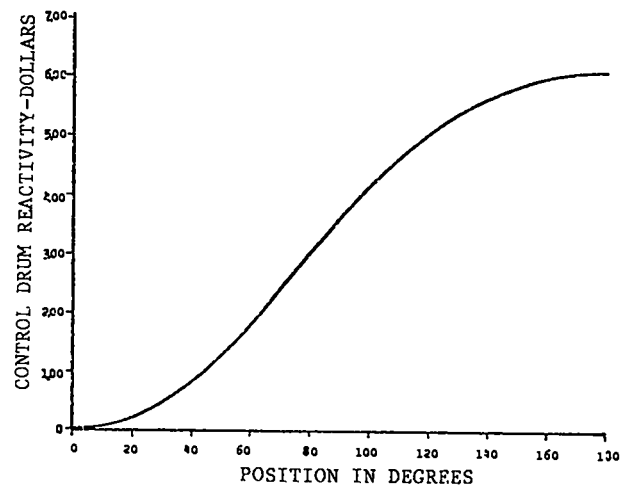

Fig. 6 Control Drum Calibration Curve for Core Number 1.

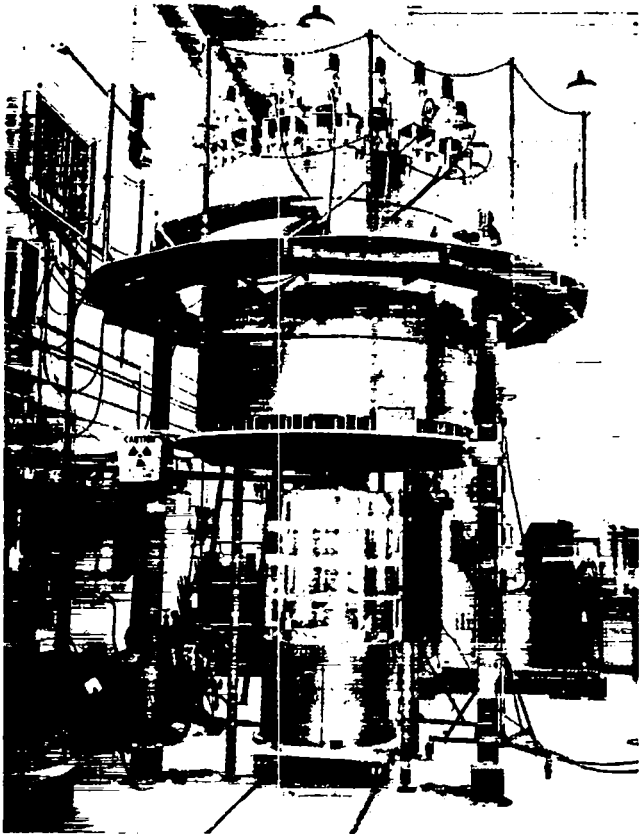

Fig. 7 Core Number 2.

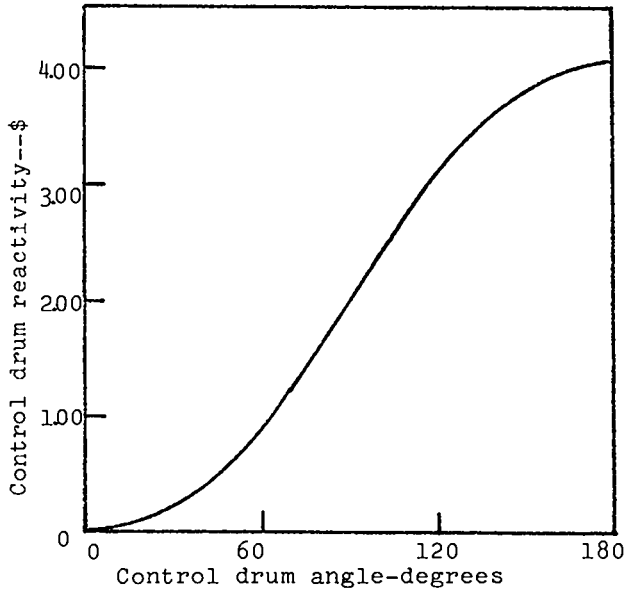

Fig. 9 Control Drum Calibration Curve for Core Number 3.

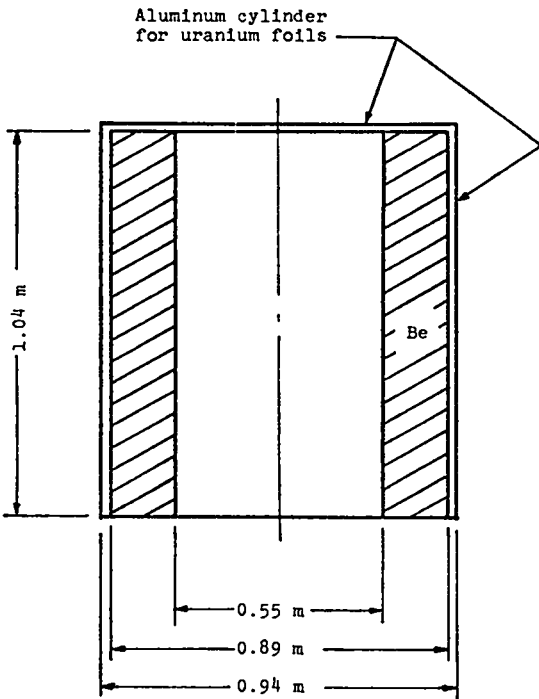

Fig. 8 Core Number 3.

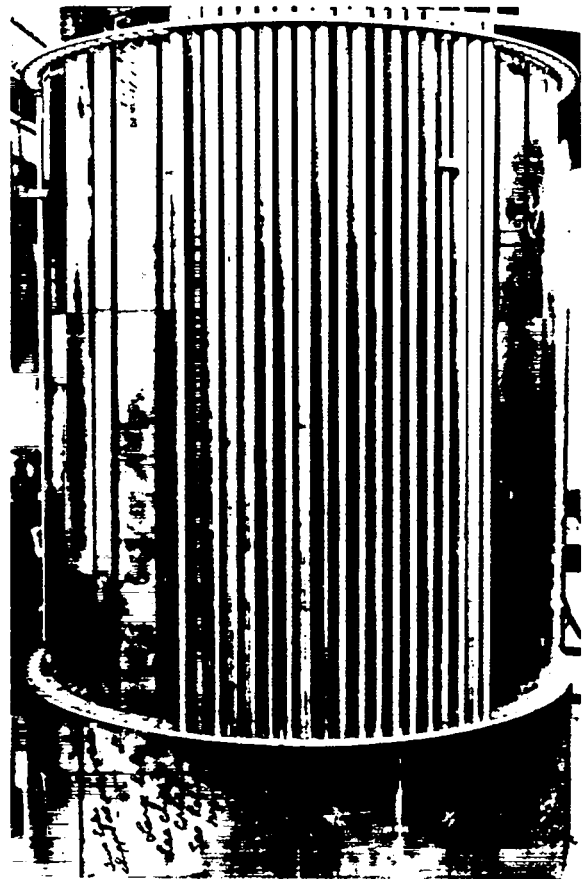

Fig. 10 Core Number 4 with Partial Load of Uranium - Graphite Fuel Rods.

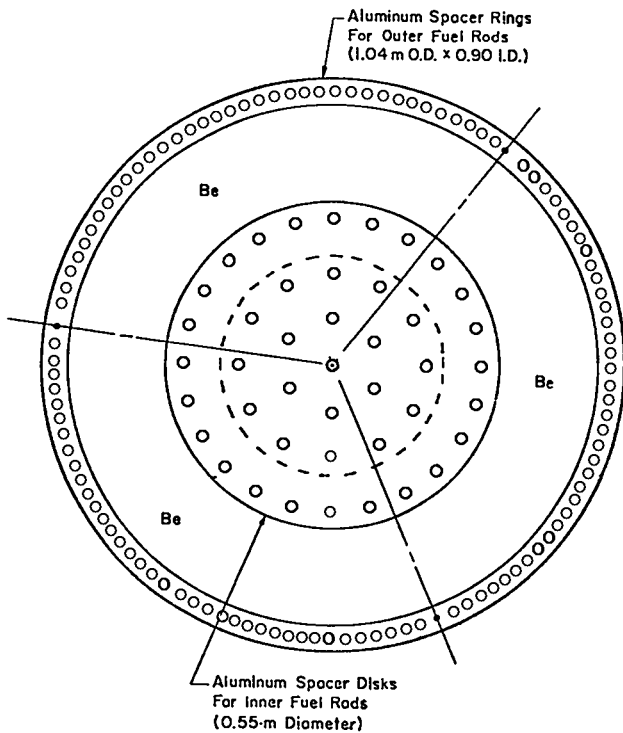

Fig. 11 Available Fuel Loading Positions in Central and Driver Zones.

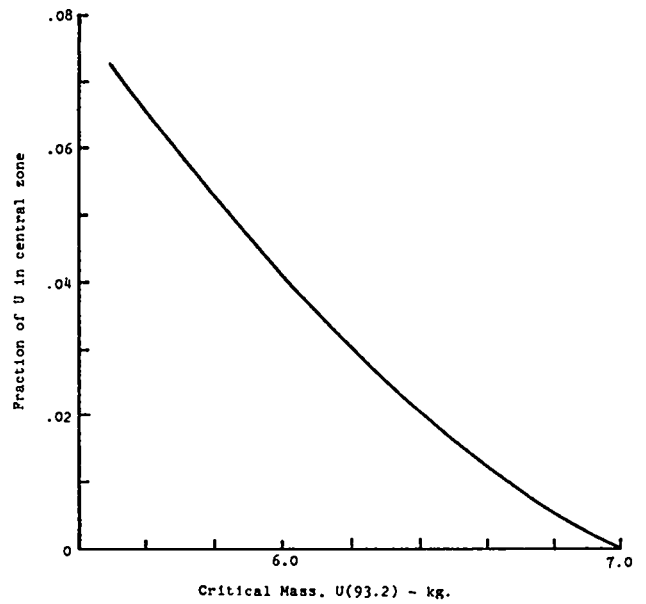

Fig. 13 Critical Mass vs. Fraction of Uranium in Central Zone.

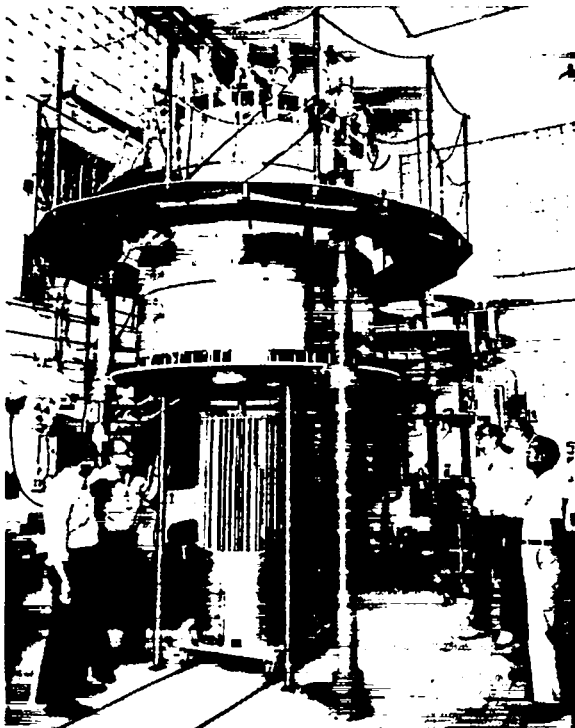
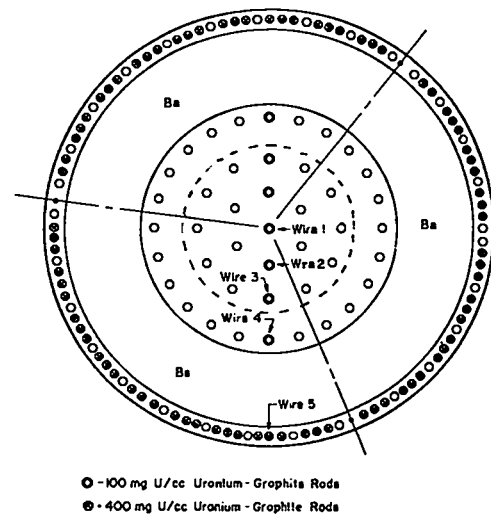

Fig. 12 Mars Machine with Core Number 4.



○ - 100 mg U/cc Uranium - Graphite Rods
 ● - 400 mg U/cc Uranium - Graphite Rods

Fig. 14 Fuel Element and Wire Positions Used in Core Number 4.

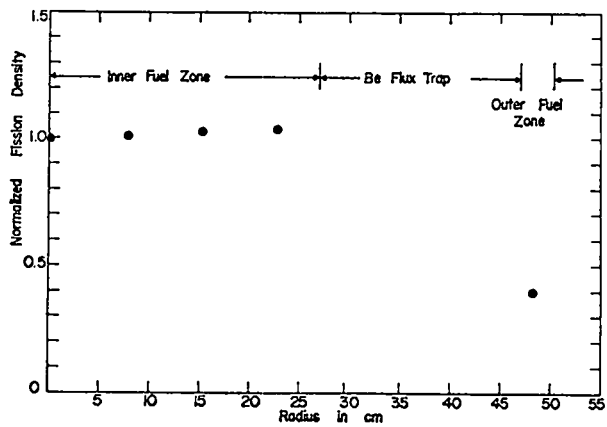

Fig. 15 Radial Fission Distribution in Core Number 4.

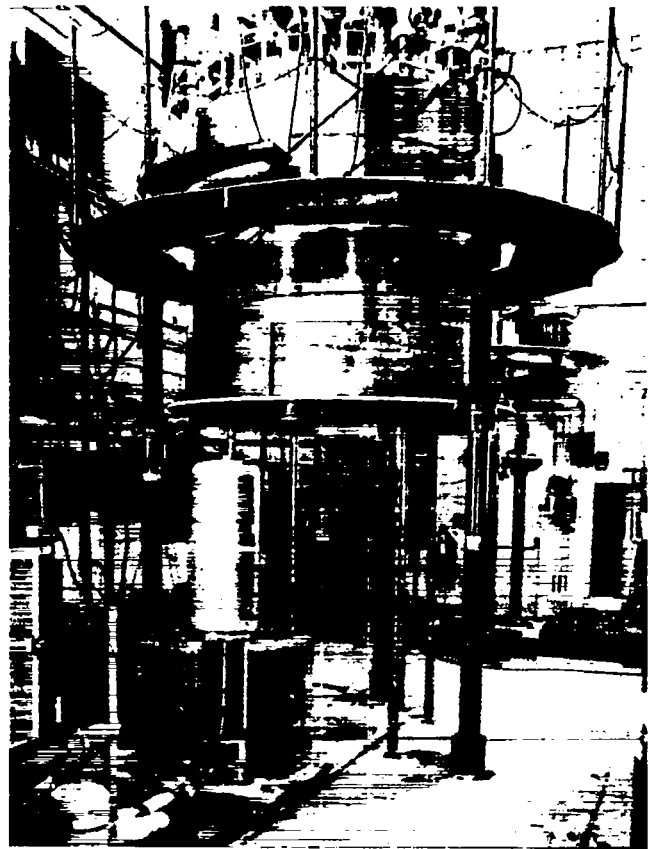

Fig. 17 Aluminum Canister for UF_6 Gas in Core Number 5.

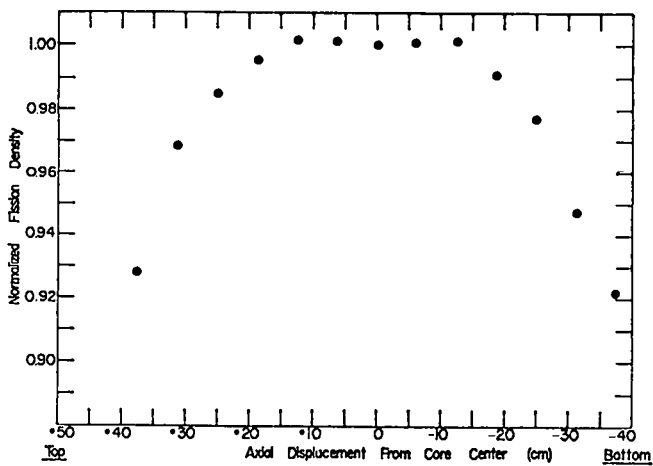

Fig. 16 Axial Fission Distribution in Core Number 4.

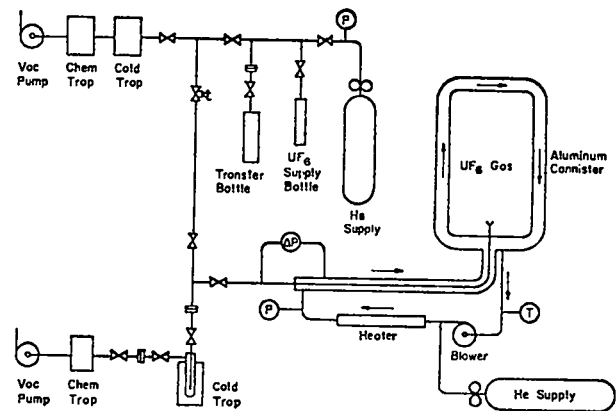

Fig. 18 Schematic of UF_6 Gas Handling System.

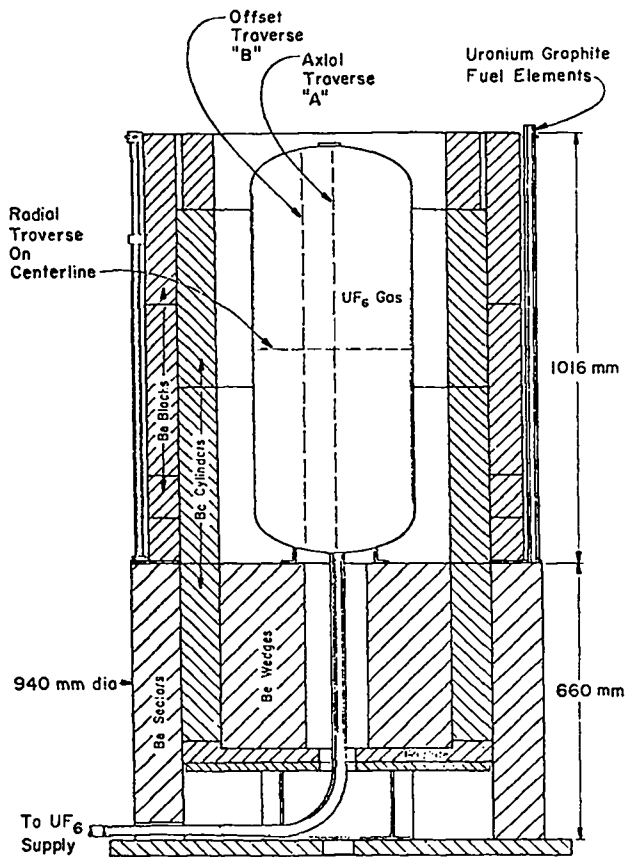

Fig. 19 Location of Fission Wires in Core Number Five.

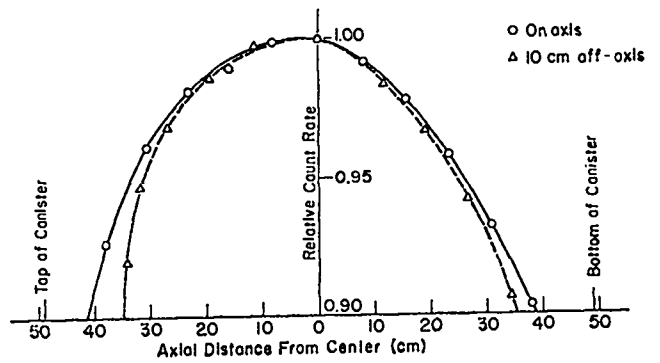

Fig. 20 Axial Fission Distributions in Core Number Five.