



UNCLASSIFIED

CLASSIFICATION CANCELLED
For The Atomic Energy Commission
by the Declassification Officer

CIC-14 REPORT COLLECTION
REPRODUCTION
COPY

per *Document Room/serf*

LA-629

PUBLICLY RELEASABLE
LANL Classification Group

77 Tom M Jones
3/13/96

~~13-18~~

C.3

May 13, 1947

This document contains 11 pages

HALF-LIFE OF TRITIUM

Work Done By:

M. Goldblatt
E. S. Robinson
R. W. Spence

Report Written By:

R. W. Spence

VERIFIED UNCLASSIFIED

Per LMR 6-11-79

By Marlene Lujan CIC-14 4-4-96

LOS ALAMOS NATIONAL LABORATORY
3 9338 00349 8804

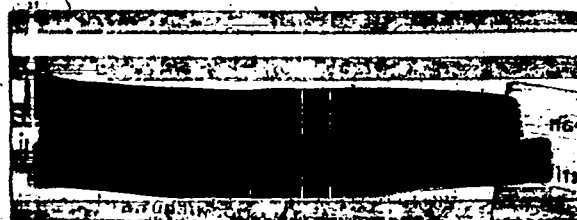

UNCLASSIFIED

Page 2

A B S T R A C T

The half-life of tritium was measured by observing the decrease with time of the ion current from an ion chamber containing tritium. The preliminary value of the half-life obtained is 10.7 ± 1.0 years.

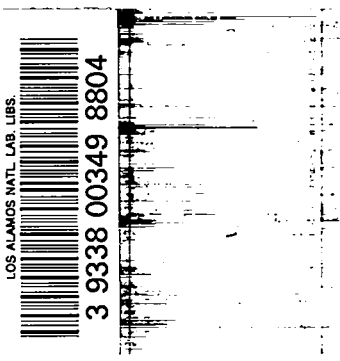

UNCLASSIFIED

HALF-LIFE OF TRITIUMINTRODUCTION:

We have determined a new value for the half-life of tritium by measuring over a period of several weeks the current produced in an ion chamber filled with a mixture of hydrogen and tritium. While the result obtained so far is only a preliminary one, it was thought worthwhile to report it now since it is considerably less than previously accepted values of 20 to 30 years.

THE ION CHAMBER

Fig. 1 shows the ion chamber used in the experiment. G and G' are the two concentric cylindrical electrodes, G fitting snugly inside the outer wall of the Pyrex vessel and G' fitting snugly over the inner Pyrex cylinder. The electrodes were made of 5-mil gold sheet; the outer electrode was 12 cm long and the inner one 10 cm long. The distance between electrodes was approximately 1 cm. The electrodes were connected to the tungsten leads by means of small nickel strips.

The ion chamber was sealed to a vacuum system, evacuated and baked, and the hydrogen-tritium mixture introduced into the chamber by use of a Toepler pump. Then the chamber was sealed off at the capillary. The per cent tritium in the mixture was not known but was probably about 60 to 70 percent. The final pressure was about 250 mm of Hg.

UNCLASSIFIED

The current vs. voltage curve for the ion chamber is given in Fig. 2. (Actually current is not plotted, but the IR drop across a 10,000-ohm standard resistance.) The slope at saturation was small; the per cent change in current per volt change in applied potential was only 0.0007%, or a change of 0.47 microvolts in the IR drop per volt change in applied potential. We used ten 67½-volt B batteries to supply the potential.

EXPERIMENTAL SET-UP:

The ion chamber was mounted in a shield as shown in Fig. 3. The electrical system was simple; the lead to the outer electrode was connected by shielded cable to the positive side of the voltage supply while the inner electrode was connected through a 10,000-ohm standard resistance to the negative end of the voltage supply. A Type K-2 Leeds and Northrup potentiometer was used to measure the IR drop across the standard resistance. It was found that readings of the IR drop (which measured about 0.065 volts) could be reproduced to one microvolt.

The entire set-up, except for the galvanometer, was placed in a thermostated box. The temperature varied between 21°C and 23°C but all measurements were corrected to 22°C by use of the empirical correction described below.

Fig. 4 shows the measured increase in the IR drop across the 10,000-ohm standard resistance as the temperature of the ion chamber was increased. At 22°C the increase was 9.1 microvolts per degree centigrade.

RESULTS:

In Fig. 5 the common logarithm of the IR drop (in microvolts) across the standard resistance is plotted against time (in days). The values of the IR drop were corrected to 22°C. The equation of the straight line obtained was calculated by the method of least squares to be:

$$\log (\text{IR drop}) = -7.81 \times 10^{-5} t + 4.81252$$

Since the slope of the line equals $1/2.303$, the measured disintegration constant for tritium is 1.80×10^{-4} . Therefore, the half-life $T_{1/2} = 0.693/\lambda = 3850 \text{ days} = 10.5 \text{ years}$.

When the experimental ordinates were compared with the ordinates calculated from the above equation it was found that the standard deviation was 9×10^{-6} , which corresponds to slightly more than 1 microvolt in the IR drop, or about the error in the potentiometer measurement. Thus the precision was very good.

DISCUSSION:

While the precision of the points on the decay curve corresponds to an error of only about 1%, we cannot claim this as the error in the half-life. There are three possible sources of error. The first is the decrease in voltage of our potential supply in the 18 days over which decay measurements were taken.

Mr. A.N. Shopp of Group P-1 kindly measured the rate at which the potential of the battery pack we used dropped with time. His measurements, taken over a period of six days, with a current drain of 10 micro-amperes, showed that the voltage decreased 0.064% per day. During the 18 days in which decay measurements were taken the change in the voltage supply would have been about

Page 6

1.15% or 7.8 volts. From the saturation curve (Fig.2) we see that the IR drop across the standard resistance decreases 0.47 microvolts for each volt decrease in the voltage supply, so that the error in the IR drop at the end of 18 days would be about 3.7 microvolts. The total change in the IR drop for the 18 days was 210 microvolts, so the half-life of 10.5 years we observed was probably low by about 2%.

A second source of error is possible: slow absorption of tritium on the electrodes and glass walls of the ion chamber. A third source of error arises from the fact that as tritium decays to He^3 the pressure in the ion chamber increases and the composition of the gas mixture changes. We do not believe either of these errors to be very large, but we cannot at present estimate their magnitude. Experiments are now under way to eliminate or provide means of correcting for the above errors. For the present we feel it best to allow a 10% total error, so that our preliminary result for the half-life of tritium is 10.7 ± 1.0 years.

REF ID: A66542

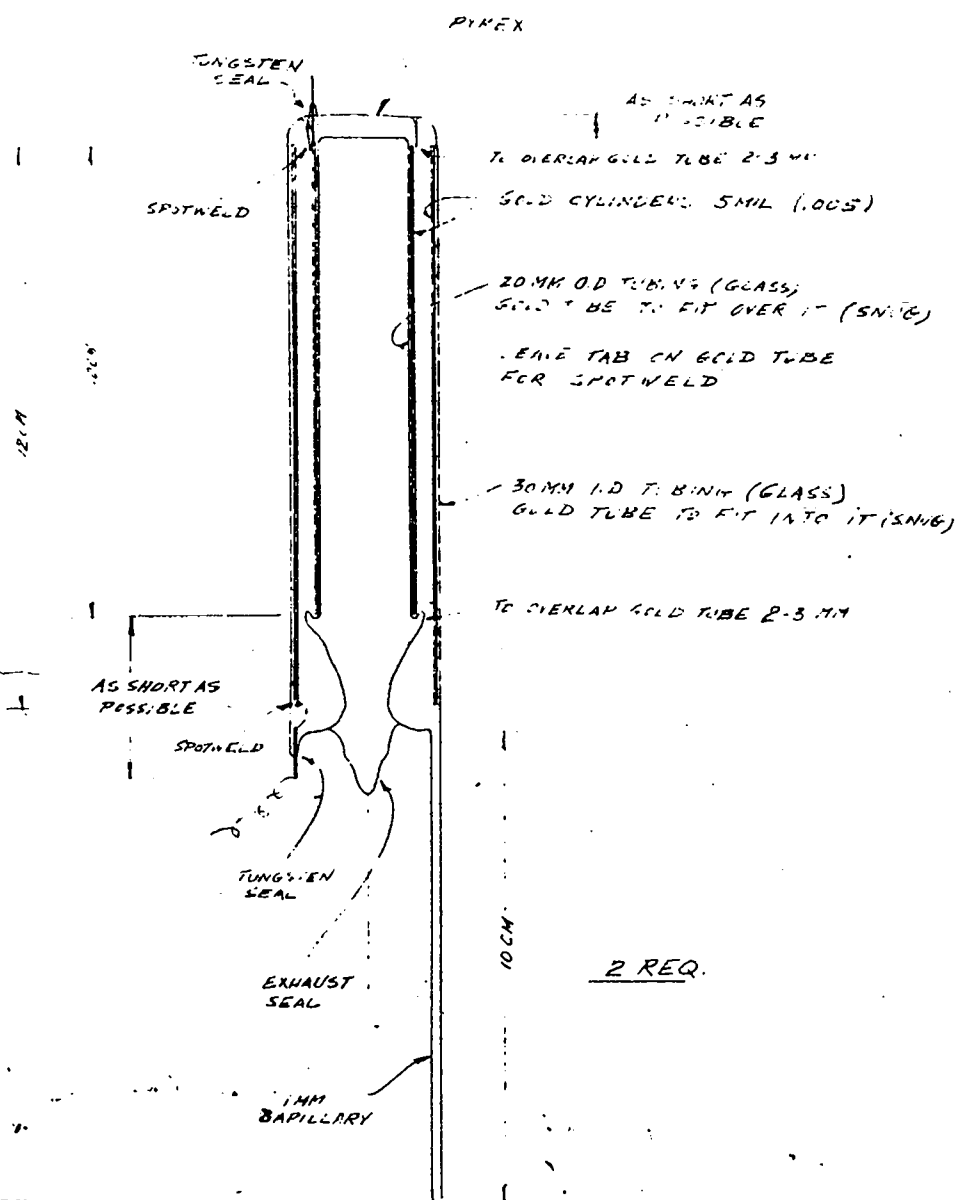

TITLE	
GOLD ELECTRODE APPARATUS	
DRAWN BY	APPROVED
DATE 11/1/41	SCALE FULL
DWG NO. S.G. 101	

Fig. 1

Saturation Curve for Chamber II 1

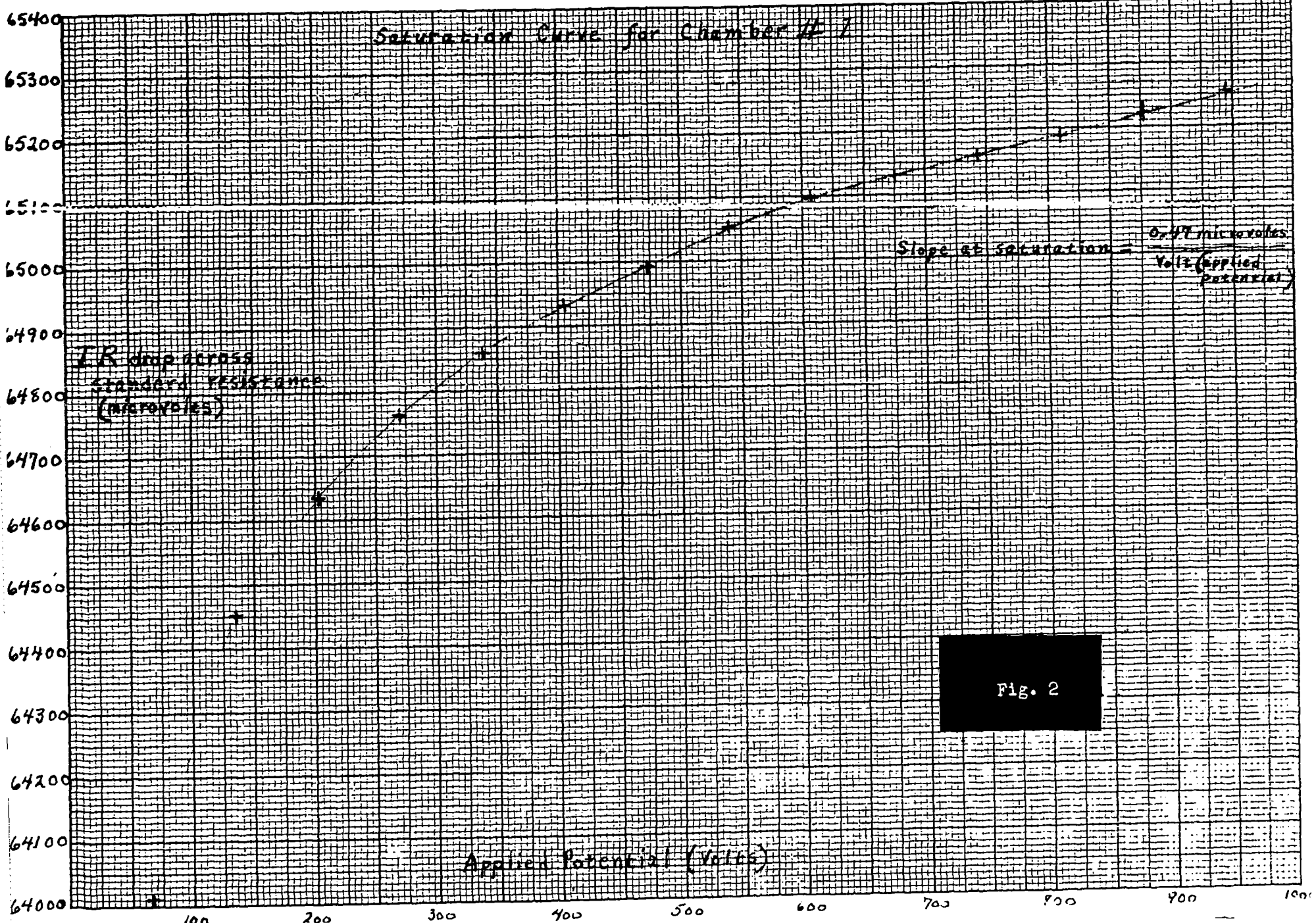

Fig. 2

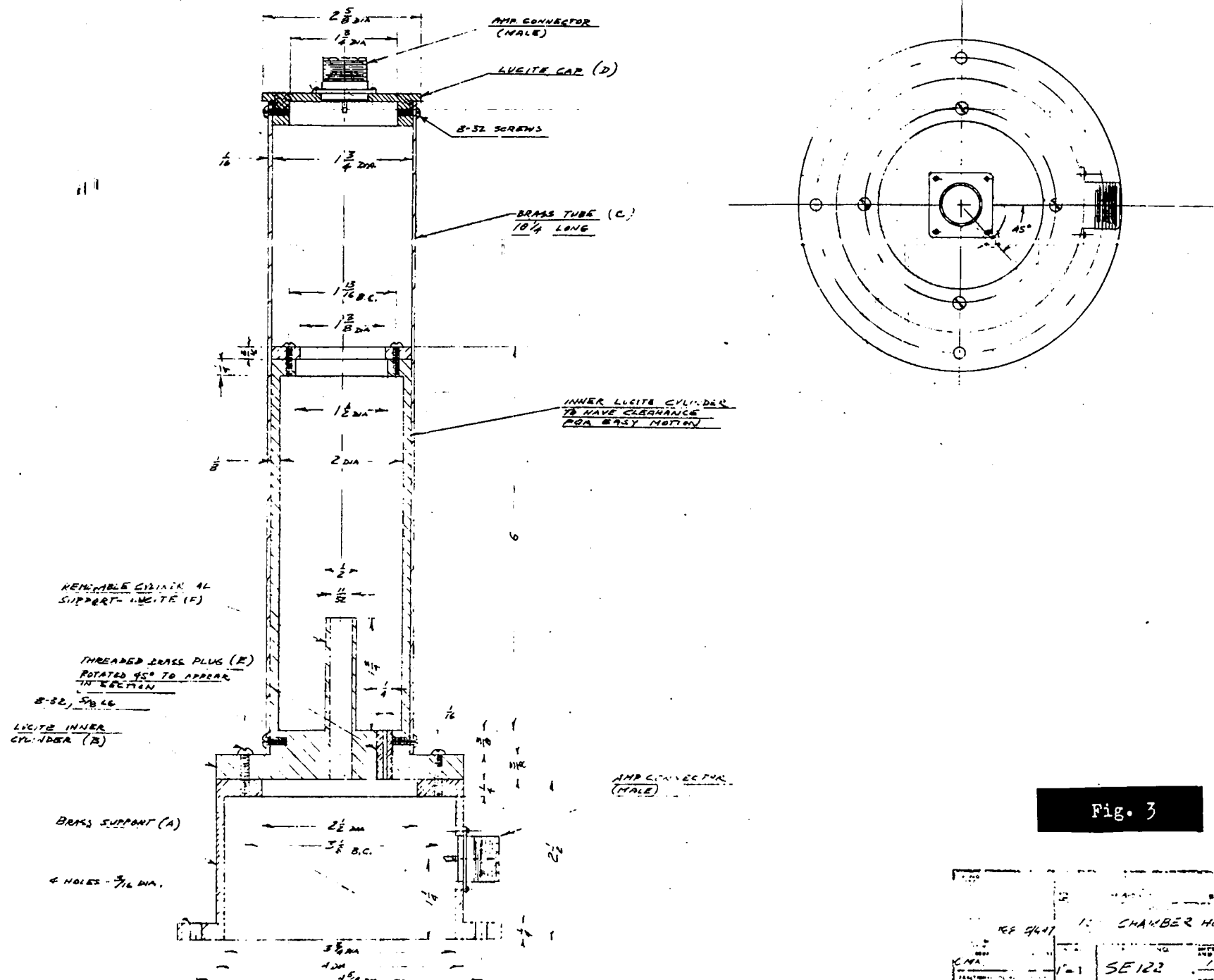

Fig. 3

REF 9441	12	CHAMBER HOL
CAP	1	SE 122
TOTAL	1	TOTAL

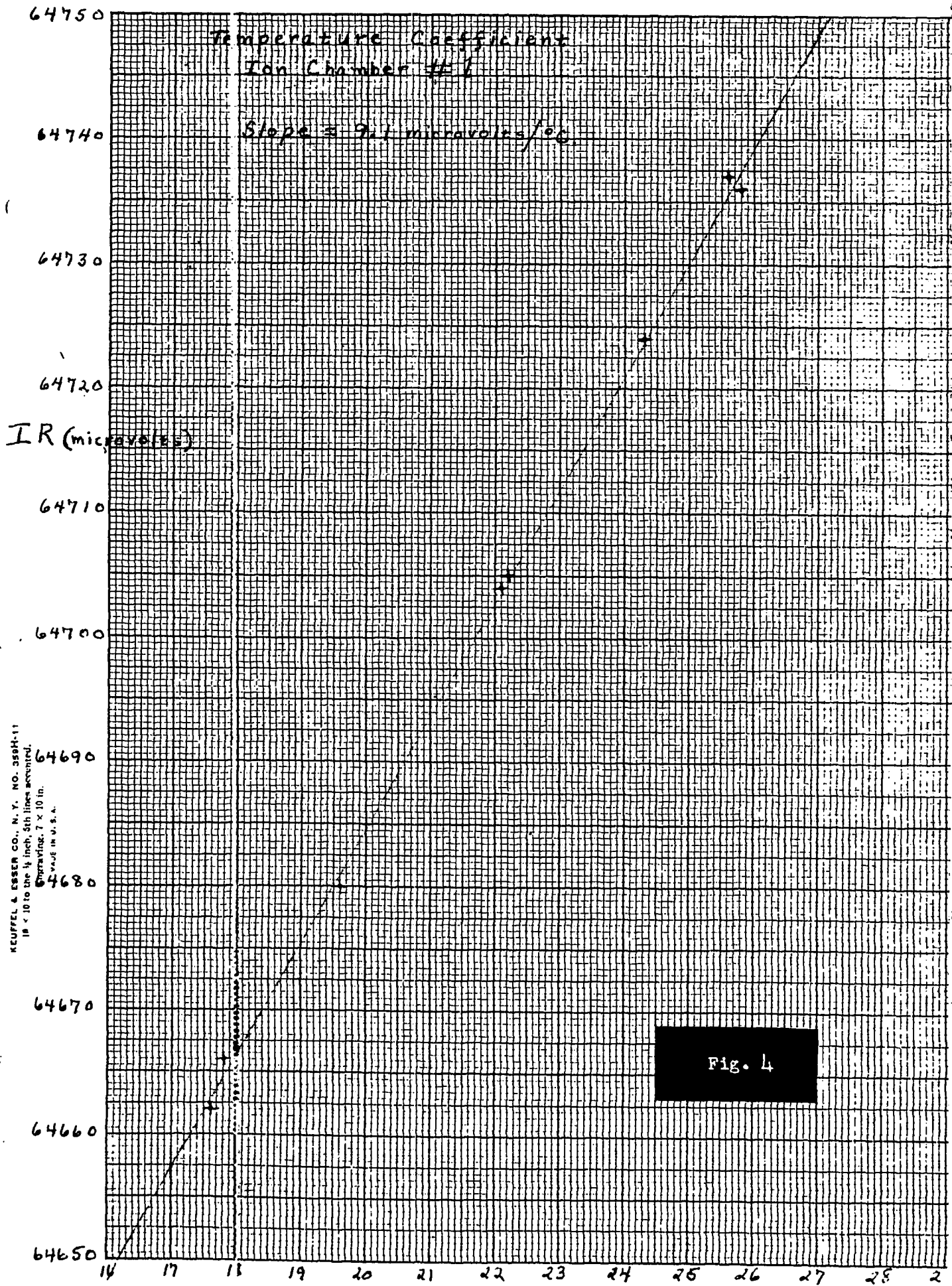

Fig. 4

KEUFFEL & ESSER CO., N. Y. NO. 358H-11
1/8" x 10" to the 1/4" inch, 5th lines accurate.
Gravating, 7 x 10 in.
MADE IN U. S. A.

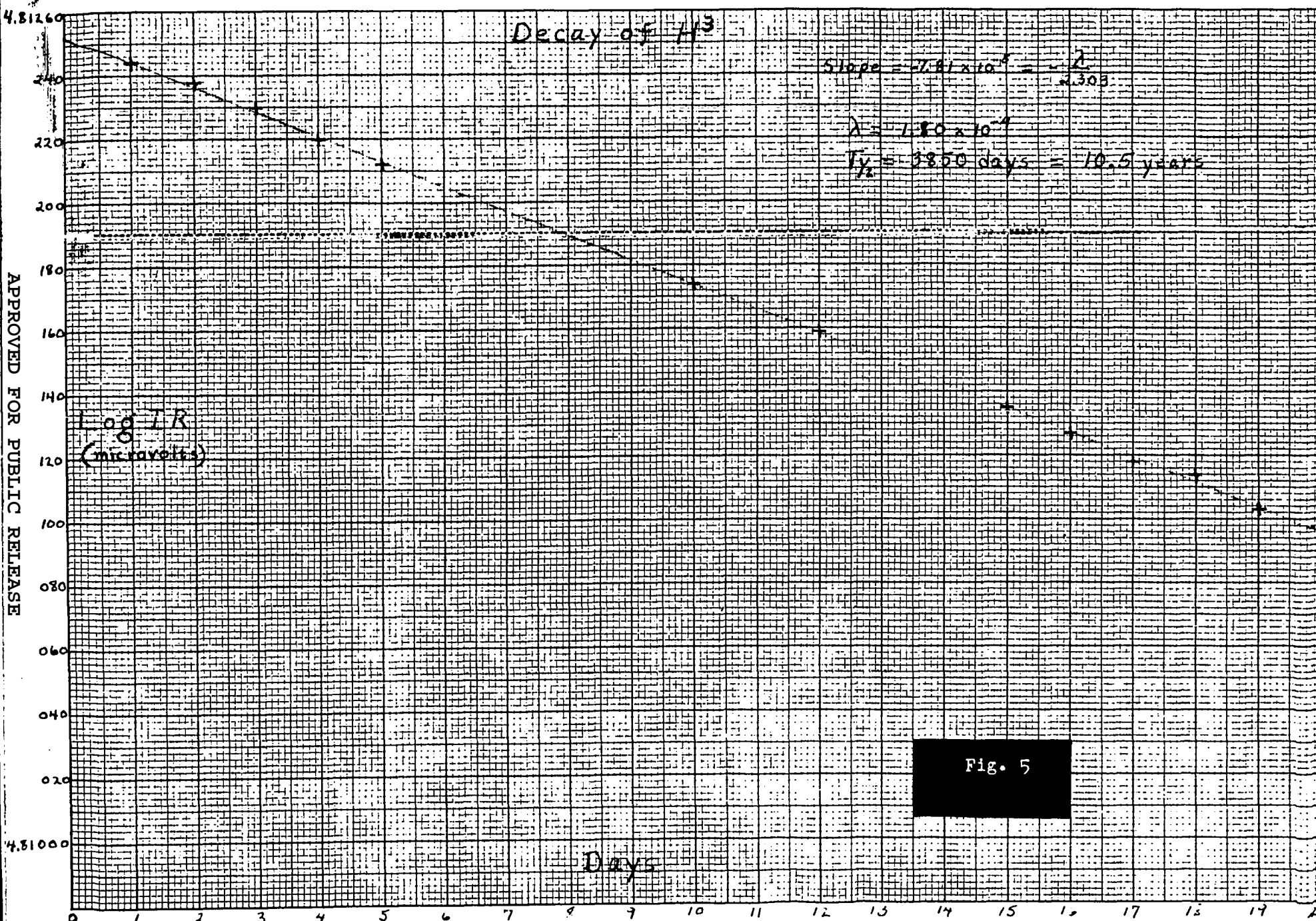

Fig. 5

UNCLASSIFIED

DOCUMENT ROOM

REC. FROM *J.M.*

DATE *5-16-47*

REC. NO. REC.

UNCLASSIFIED

