

UNCLASSIFIED

LA-2046  
Copy No.

C.3

AEC RESEARCH AND DEVELOPMENT REPORT

LOS ALAMOS SCIENTIFIC LABORATORY  
OF THE UNIVERSITY OF CALIFORNIA ○ LOS ALAMOS NEW MEXICO

Classification changed to UNCLASSIFIED  
by authority of the U. S. Atomic Energy Commission.

Per H. F. Carroll 4/1/69  
By REPORT LIBRARY H. K. ... 4/17/69

NONWEAPONS ACTIVITIES AT LOS ALAMOS SCIENTIFIC LABORATORY

Part I

Controlled Thermonuclear Reactions



LOS ALAMOS NATL. LAB. LIBS.  
3 9338 00318 1160

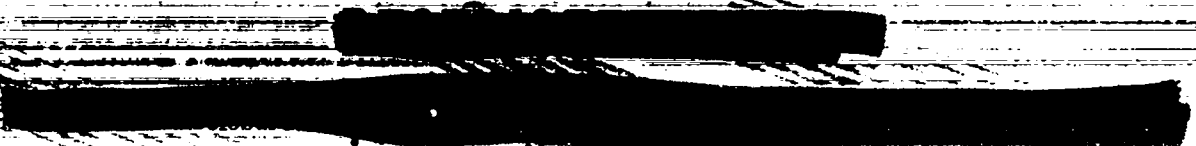

UNCLASSIFIED

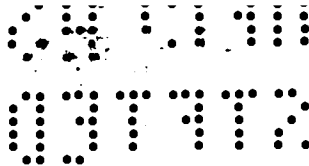

UNCLASSIFIED

## LEGAL NOTICE

This report was prepared as an account of Government sponsored work. Neither the United States, nor the Commission, nor any person acting on behalf of the Commission:

A. Makes any warranty or representation, express or implied, with respect to the accuracy, completeness, or usefulness of the information contained in this report, or that the use of any information, apparatus, method, or process disclosed in this report may not infringe privately owned rights; or

B. Assumes any liabilities with respect to the use of, or for damages resulting from the use of any information, apparatus, method, or process disclosed in this report.

As used in the above, "person acting on behalf of the Commission" includes any employee or contractor of the Commission to the extent that such employee or contractor prepares, handles or distributes, or provides access to, any information pursuant to his employment or contract with the Commission.

Printed in USA. Charge 45 cents. Available from the U. S. Atomic Energy Commission, Technical Information Service Extension, P. O. Box 1001, Oak Ridge, Tennessee. Please direct to the same address inquiries covering the procurement of other classified AEC reports.

UNCLASSIFIED

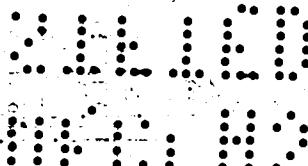

UNCLASSIFIED

TOP SECRET

PUBLICLY RELEASABLE  
LANL Classification Group  
*P. Holsten*  
9/8/98

LA-2046

CONTROLLED THERMONUCLEAR  
PROCESSES (Distributed according  
to M-3679, 18th edition)

This document consists of 46 pages  
No.            of 165 copies, Series A

LOS ALAMOS SCIENTIFIC LABORATORY  
OF THE UNIVERSITY OF CALIFORNIA    LOS ALAMOS    NEW MEXICO

REPORT WRITTEN: June 1956

REPORT DISTRIBUTED: NOV - 2 1956

NONWEAPONS ACTIVITIES  
AT LOS ALAMOS SCIENTIFIC LABORATORY  
Part I  
Controlled Thermonuclear Reactions



by

Samuel Glasstone

Contract W-7405-ENG. 36 with the U. S. Atomic Energy Commission

[REDACTED]

LOS ALAMOS NATIONAL LABORATORY  
3 9338 00318 1160

TOP SECRET

UNCLASSIFIED

UNCLASSIFIED



  

CONTROLLED THERMONUCLEAR PROCESSES  
LA-2046

Los Alamos Report Library	1-47
Air Force Cambridge Research Center	48
Albuquerque Operations Office	49
Argonne National Laboratory	50-53
Armed Forces Special Weapons Project, Washington	54
Assistant Secretary of the Air Force, R&D	55
Atomic Energy Commission, Washington	56-61
Brookhaven National Laboratory	62-64
Chicago Operations Office	65
Chief of Naval Research	66
Massachusetts Institute of Technology (Ashby)	67-68
Naval Research Laboratory	69-70
New York Operations Office	71
New York University	72-74
Oak Ridge Operations Office (Dr. H. M. Roth)	75
Office of the Chief of Naval Operations (OP-361)	76
Patent Branch, Washington	77
Princeton University	78-83
Princeton University (Smyth)	84
San Francisco Operations Office	85
Sandia Corporation	86
Schenectady Operations Office (Dr. W. F. Westendorp)	87
State University of Iowa (Van Allen)	88
Union Carbide Nuclear Company (ORNL)	89-91
University of Alabama	92
University of California Radiation Laboratory, Berkeley	93-98
University of California Radiation Laboratory, Livermore	99-103
University of Illinois	104
University of Michigan	105
Westinghouse Electric Company (Alpert)	106
Westinghouse Electric Company (Shoupp)	107
USAF Project RAND	108
National Advisory Committee for Aeronautics, Cleveland	109
Technical Information Service Extension (For Official AEC Use)	110-114
Technical Information Service Extension, Oak Ridge	115-164
Special Distribution:	
Manager, ALO (Russell Ball)	165

UNCLASSIFIED

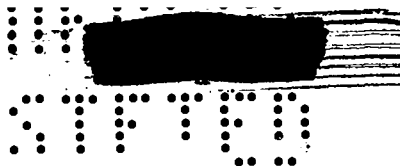
UNCLASSIFIED

## FOREWORD

In the early part of 1954, there were issued two reports (LA-1632 and 1633) summarizing the weapons activities at Los Alamos Scientific Laboratory. These reports were intended primarily for the information of new staff members of the Laboratory and for interested representatives of the Armed Forces and the Atomic Energy Commission. During the past two or three years, the work of the Laboratory has greatly expanded into applications of nuclear energy which are significant for national defense and security, but are not directly connected with weapons development. It was felt, therefore, that a description of the nonweapons activities of the Laboratory would serve a useful purpose at this time.

For classification reasons, it has been necessary to issue the report in three parts; the first is concerned with controlled thermonuclear reactions, the second with nuclear propulsion, and the third with power reactor experiments. As with the reports on weapons activities, the present reports are not intended to discuss the various topics in great detail, but rather to describe the underlying principles. Their basic purpose is to present a general background of the subject and to indicate the lines along which work is in progress in the Laboratory. It is in the hope that the material contained in them will prove useful to new staff members and to others concerned with the activities of the Laboratory that these reports have been prepared.

Norris E. Bradbury  
Director

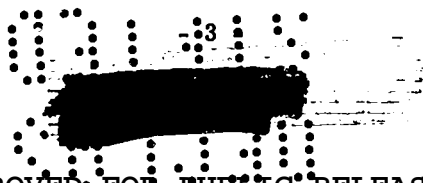

UNCLASSIFIED

UNCLASSIFIED

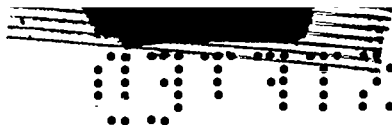

ACKNOWLEDGMENT

I wish to take this occasion to express my sincere thanks to the many members of the Laboratory who helped, in one way or another, in the preparation of this report. Their generous and wholehearted cooperation not only greatly simplified my task, but made it a pleasure and a privilege. I would also like to thank the Director of the Laboratory and his staff for giving me the unique opportunity to write this series of reports, and for providing the facilities which made the work possible.

Samuel Glasstone

UNCLASSIFIED

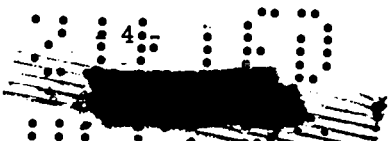

UNCLASSIFIED

Introduction

From the known masses of the neutron and of the lightest atomic nuclei, it can be shown that many of the reactions involving these nuclei are accompanied by the release of appreciable amounts of energy. It will be seen below that certain of these reactions can be initiated (and maintained) at high temperatures, and so they are referred to as "thermonuclear reactions." Such reactions occur in the sun and stars, and they have also been made to take place on earth by utilizing the energy from a fission bomb to obtain the required high temperatures. However, in this case the thermonuclear energy is released in an uncontrolled (explosive) manner. The controlled release of the energy appears to be a very much more difficult matter, and it is with this aspect of the problem that the present report is concerned. The basic principles underlying thermonuclear reactions will be described, and possible methods for bringing them about will be considered, with special reference to the work being done at Los Alamos Scientific Laboratory.

The special interest in controlled thermonuclear power arises from the fact that the probable "fuel" material will be deuterium, the hydrogen isotope which is present to the extent of 1 atom to 6500 atoms of ordinary hydrogen in water. In spite of this apparently small proportion, it is estimated that the oceans contain a total of more than  $10^{17}$  pounds of deuterium. If this could be utilized, in apparently reasonable thermonuclear reactions, for the controlled release of energy, the total available would be at least  $10^{20}$  kilowatt-years. The world's present power consumption is at the rate of approximately  $4 \times 10^9$  kilowatts. Hence, the deuterium in water represents, in principle, a virtually inexhaustible store of energy, even allowing for a considerable increase in future power demands.

The price paid by the consumer for electricity is determined mainly by capital charges and distribution costs, and only to a minor extent by the cost of the fuel. Nevertheless, it is of interest to mention that deuterium would be a cheap fuel. At the present time, the AEC is selling heavy water (deuterium oxide) at \$28 per pound; this is equivalent to about \$140 per pound for the contained deuterium. It is probable that 1 lb of deuterium could produce about  $2 \times 10^7$  kw-hr, so that the cost of the fuel would be less than 0.0014 cents per kw-hr.\*

Of the three isotopes of hydrogen, namely, hydrogen ( $H^1$ ), deuterium ( $D^2$ ), and tritium ( $T^3$ ), the only reactions of interest are those between two deuterium nuclei and between a

\* The fission of 1 lb of uranium<sup>235</sup> or plutonium<sup>239</sup> releases  $10^7$  kw-hr of energy.

UNCLASSIFIED

UNCLASSIFIED



deuterium and a tritium nucleus, i. e., the DD and DT reactions. Nuclear processes in which protons are one of the reacting species are not very important because their probabilities (or cross sections) are so small that impossibly high temperatures would be required for them to occur at useful rates.

Further, reactions between two tritium nuclei, i. e., TT reactions, need not be considered for the release of energy because of the high cost and radioactivity of the tritium. The proportion of this isotope in natural hydrogen is negligibly small, and the method used for its preparation, at present, involves interaction of neutrons with lithium ( $\text{Li}^6$ ) in a nuclear reactor. It will be apparent shortly that tritium might become much cheaper if controlled thermonuclear reactions prove to be possible. But even if this were the case, the tritium would probably be used in DT, rather than in TT, reactions.

#### Deuterium and Tritium Reactions

Deuterium nuclei can interact with each other in two different ways, for which the cross sections are virtually equal; thus, under given conditions, the two reactions occur at about the same rates. These two reactions are

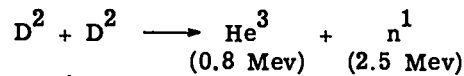

and

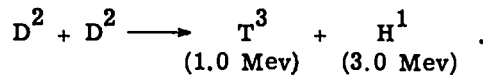

The total energy released in the first reaction (neutron branch) is about 3.3 Mev, and in the second (proton branch) it is about 4.0 Mev. These energies are distributed between the products in each case in the manner shown, so that momentum is conserved.

The tritium nuclei formed in the proton branch, or introduced in any other manner, will react with deuterium, thus,

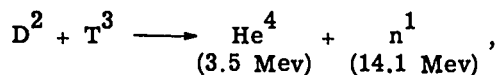

the total energy release being 17.6 Mev. The probability of this DT reaction, under conditions of interest for the present problem, is about 50 to 100 times as great as that of the total DD reaction. Hence, in a system containing deuterium as the only hydrogen isotope, the tritium produced in the proton branch of the DD reaction may be regarded as reacting with deuterium almost as fast as it is formed.

If all the energy released in the three reactions considered above were available, the



UNCLASSIFIED



UNCLASSIFIED

interaction of five deuterium nuclei would be accompanied by  $3.3 + 4.0 + 17.6 = 24.9$  Mev of energy. In the methods currently being considered for controlling thermonuclear reactions, the neutrons would probably escape from the immediate reaction environment. Only the energy carried by the charged particle products, i. e.,  $H^1$ ,  $T^3$ ,  $He^3$ , and  $He^4$ , would thus be available locally to raise the temperature of the interacting nuclei by colliding with them. If the energy (16.6 Mev) of the neutrons is subtracted from the total, there remains 8.3 Mev for every five deuterons used up in reactions.

It should be noted, however, that if controlled thermonuclear reactions prove possible, the neutrons produced will certainly not be wasted. Heat will be liberated as the neutrons are slowed down, and the slow neutrons can be allowed to interact with the  $Li^6$  present in ordinary lithium, thus,

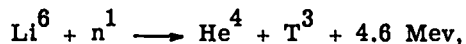

in which some energy is released. More important, however, is the fact that tritium is produced and can be used in the DT reaction. Another possibility is the interaction of neutrons with  $He^3$  formed in the neutron branch of the DD reaction, i. e.,

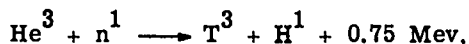

from which tritium is also obtained. A reasonable estimate would thus be a total of 16 Mev for every five deuterons consumed; this leads to the result given earlier of  $2 \times 10^7$  kw-hr per pound of deuterium.

#### The Coulomb Barrier

When two nuclei are brought together, as a preliminary to interaction, there is an increasing force of electrostatic (or coulomb) repulsion of their positive charges. At a certain distance apart, however, the (short range) nuclear attractive forces just exceed the (long range) forces of repulsion. At this point interaction between the nuclei becomes possible. The variation of the potential energy of the system of two nuclei, with their distance apart, is shown in Fig. 1; positive values of the potential energy indicate net repulsion whereas negative values imply net attraction.

According to classical theory, the energy which must be supplied to the nuclei to surmount the coulomb potential barrier, i. e., the energy required to overcome the electrostatic repulsion so that reaction can occur, is given by

$$\text{Energy to surmount coulomb barrier} = ZZ'e^2/R_0$$

UNCLASSIFIED

UNCLASSIFIED

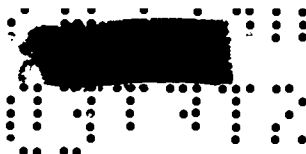

where  $Z$  and  $Z'$  are the respective charges (or atomic numbers) of the interacting nuclei,  $e$  is the unit charge, and  $R_0$  is the distance between the nuclei at which the attractive forces become dominant (see Fig. 1).

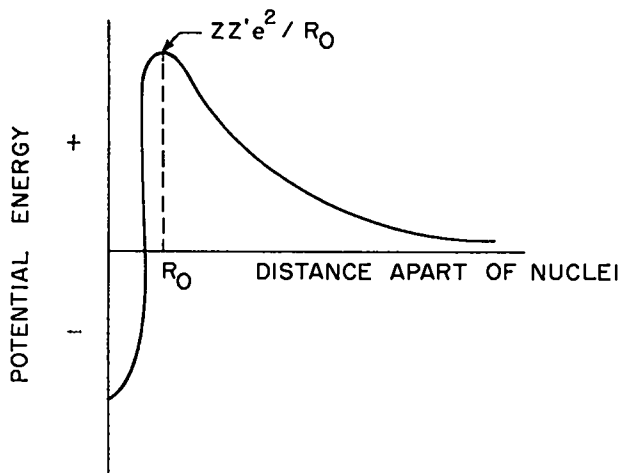

Fig. 1

The height of the coulomb barrier evidently increases with the atomic numbers of the interacting nuclei. Since thermonuclear reactions involving nuclei of hydrogen isotopes are essentially the only ones to be considered here, the values of  $Z$  and  $Z'$  are both unity. A reasonable value for  $R_0$  in these circumstances, e.g., for the reaction between two deuterium nuclei, is  $8 \times 10^{-13}$  cm, and since  $e$  is  $4.80 \times 10^{-10}$  esu, it follows that the energy required to surmount the coulombic barrier in this case is  $2.9 \times 10^{-7}$  erg or 0.18 Mev. It would appear, therefore, that approximately 200 kev of energy would have to be supplied to a pair of deuterium nuclei before they could react.

#### Penetration of the Coulomb Barrier: Cross Sections

In practice, it has been found, by experiments on various nuclear interactions made with accelerators, that reaction can occur at appreciable rates even when the energies are considerably below those corresponding to the top of the coulomb barrier. This ability to "penetrate" the barrier is a consequence of the fact that nuclei obey the laws of wave mechanics rather than of classical mechanics. Thus, there is a certain probability that two nuclei will interact even though they do not have sufficient energy to surmount the coulomb barrier. The cross section for a given nuclear reaction decreases with decreasing energy, but it is nevertheless finite even at very low energies. This means that thermonuclear reactions will occur at energies (or temperatures) much below those to be expected from classical considerations.

UNCLASSIFIED



The cross sections for the DD and DT reactions mentioned above have been measured over a range of energies, by using an accelerator, e. g., a Cockcroft-Walton machine, to impart known energies to deuterium nuclei (deuterons) which then interact with stationary targets containing deuterium or tritium. The results are shown in Fig. 2, in which the cross sections are represented as a function of the deuteron energy.\* The curve marked DD gives the total cross sections for both DD reactions; at energies less than about 50 kev, the cross sections of the two DD reactions are essentially the same.

It will be observed that, in spite of the wave-mechanical "penetration" of the coulomb barrier, the cross sections are still fairly small, at least for the DD reaction, at energies less than 100 kev (0.1 Mev). Thus, basically, due to electrostatic repulsion, the probabilities of reactions between two nuclei are small, even when their charges are the smallest possible, as they are for the isotopes of hydrogen. With increasing atomic number the electrostatic repulsion increases and the probability of interaction becomes less. It would be expected that reactions involving helium or other nuclei of higher atomic number would be even less probable. This is supported by the observation that the cross sections for the DHe<sup>3</sup> reaction are considerably smaller than for the DT reaction. They are even less than for the DD reaction over the range of energies measured.

#### Rates of Thermonuclear Reactions

In a binary nuclear reaction in a system containing  $N_1$  and  $N_2$  nuclei per  $\text{cm}^3$ , respectively, of the two interacting species, having a constant relative velocity  $v$ , the reaction rate is given by

$$\text{Nuclear reaction rate} = N_1 N_2 \sigma v \text{ interactions per cm}^3 \text{ per sec,} \quad (1)$$

where  $\sigma$  is the cross section for the given reaction at the particular energy corresponding to the velocity  $v$ . If the reaction occurs between two nuclei of the same kind, as in the DD reactions, so that  $N_1$  and  $N_2$  are equal, the rate expression becomes

$$\text{Nuclear reaction rate} = 1/2 N^2 \sigma v \text{ interactions per cm}^3 \text{ per sec,} \quad (2)$$

where  $N$  is the number of reactant nuclei per  $\text{cm}^3$ . In order that each interaction between identical nuclei should not be counted twice, the factor of one half is introduced in the rate equation (2).

The foregoing equations (1) and (2) are applicable when the relative velocity  $v$  is approximately constant, as it is for nuclear reactions with particles from an accelerator. For

---

\* Physical Review, 93, 483 (1954); see also, Phil. Mag., 46 [7], 800 (1955).

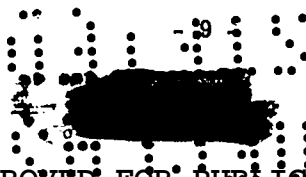

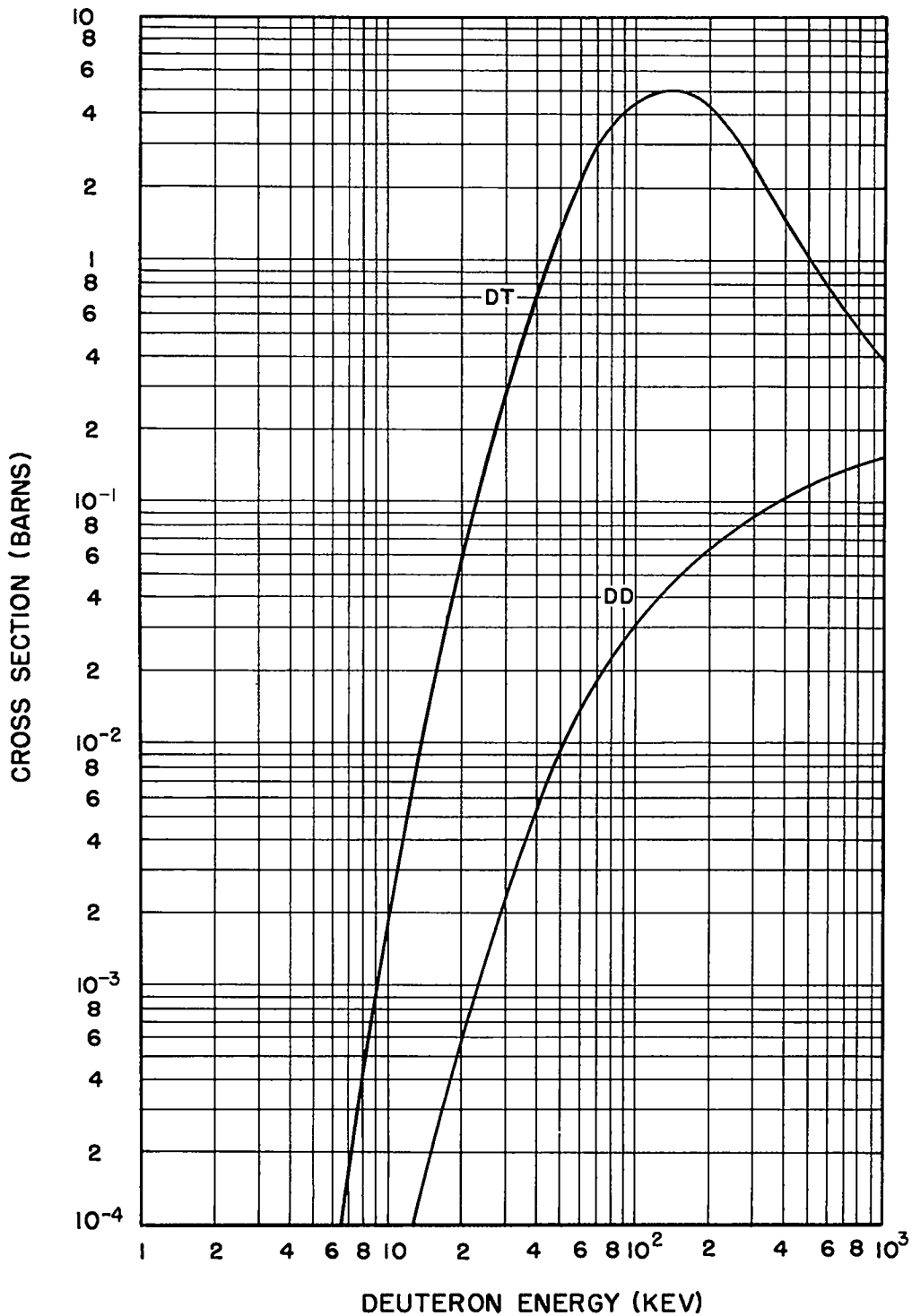
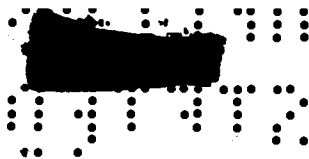
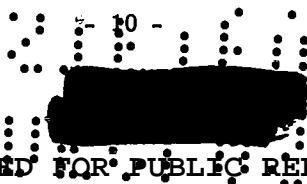
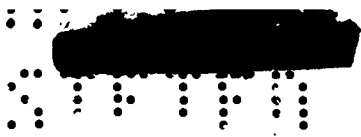

Fig. 2 DD and DT reaction cross sections as a function of energy.





thermonuclear reactions, however, it is to be expected that there will be a distribution of velocities (and energies) over a wide range, from extremely small to very large. Since  $\sigma$  and  $v$  are related, the value of the product  $\sigma v$  averaged over the whole range of velocities, i. e.,  $\overline{\sigma v}$ , should replace  $\sigma v$  in equations (1) and (2). These equations should therefore be written as

$$\text{Nuclear reaction rate} = N_1 N_2 \overline{\sigma v} \text{ or } 1/2 N^2 \overline{\sigma v} \tag{3}$$

interactions per  $\text{cm}^3$  per sec.

In a system in which thermonuclear reactions are occurring, because of the high temperature, there will be many collisions among the nuclei and electrons present. It appears probable that a Maxwellian distribution of velocities will then exist. In this event,

$$\overline{\sigma v} = \frac{\int_0^\infty \sigma v \left[ v^2 e^{-\mu v^2 / 2kT} dv \right]}{\int_0^\infty v^2 e^{-\mu v^2 / 2kT} dv}, \tag{4}$$

where the quantity in the brackets is the Maxwell velocity distribution function. In this equation,  $v$  is the relative velocity of the interacting nuclei, as before,  $T$  is the absolute temperature,  $k$  is the Stefan-Boltzmann constant ( $1.4 \times 10^{-16}$  erg per degree K), and  $\mu$  is the reduced mass of the nuclei, i. e.,

$$\mu = \frac{m_1 m_2}{m_1 + m_2},$$

where  $m_1$  and  $m_2$  are the actual masses of the reacting nuclear species. The integral in the denominator of equation (4) is a standard form, so that this equation reduces to

$$\overline{\sigma v} = \frac{4}{\sqrt{\pi}} \left( \frac{\mu}{2kT} \right)^{3/2} \int_0^\infty \sigma v^3 e^{-\mu v^2 / 2kT} dv. \tag{5}$$

The remaining integral can best be evaluated by changing the variable to  $E$  instead of  $v$ , especially as the curves in Fig. 2 give  $\sigma$  for the DD and DT reactions as a function of the deuteron energy. In this case, therefore,  $E = 1/2 m_d v^2$ , where  $m_d$  is the actual mass of the deuteron, so that

$$v = \left( \frac{2E}{m_d} \right)^{1/2}.$$

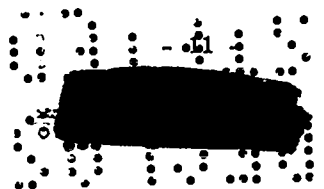

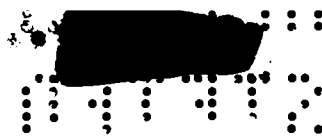

Hence,

$$v^3 dv = \frac{2}{m_d} E dE$$

and equation (5) can be written as

$$\overline{\sigma v} = \frac{8}{\sqrt{\pi}} \left( \frac{\mu}{2kT} \right)^{3/2} \frac{1}{m_d} \int_0^{\infty} \sigma E e^{-\mu E/m_d kT} dE, \quad (6)$$

where  $\sigma$  is the cross section for a deuteron of energy  $E$ .

It has become the common practice in thermonuclear work to express temperatures in terms of the corresponding energy  $kT$ , in kiloelectron volt units, i. e., in kev. Since the Stefan-Boltzmann constant is  $1.4 \times 10^{-16}$  erg per degree K and 1 kev is  $1.6 \times 10^{-9}$  erg, it follows that

$$k = 8.6 \times 10^{-8} \text{ kev per degree K}$$

or

$$1 \text{ kev} \equiv 1.16 \times 10^7 \text{ degrees K.}$$

Thus, a temperature of  $T$  kev is equivalent to  $1.16 \times 10^7 T$  degrees K.

If the temperature,  $T$ , is converted into kev units and the values of  $E$  are in the same units, it is convenient to rewrite equation (6) in the form

$$\overline{\sigma v} = \frac{8}{\sqrt{\pi T}} \left( \frac{\mu}{2} \right)^{3/2} \frac{1}{m_d} \int_0^{\infty} \sigma \frac{E}{T} e^{-\mu E/m_d T} dE,$$

where the quantity  $E/T$  is dimensionless. By using Simpson's rule, together with the data in Fig. 2, the values of  $\overline{\sigma v}$  for the DD and DT reactions have been determined as a function of the temperature (in kev), assuming a Maxwellian distribution of velocities. The results are given in Fig. 3.\*

The effect of taking into account the Maxwellian distribution is quite appreciable. For example, at a temperature of 20 kev, the value of  $\overline{\sigma v}$  for the DD reaction is  $3.6 \times 10^{-18} \text{ cm}^3$  per sec. If all the nuclei had the same energy (or velocity), however,  $\sigma v$  at this temperature would be only about  $1.4 \times 10^{-19} \text{ cm}^3$  per sec. As a result of the energy distribution, therefore, the DD reaction rate is increased by a factor of roughly 25 at a temperature of 20 kev.

\* Cf. LA-1190, for original treatment; revised data are given in LAMS-1640.

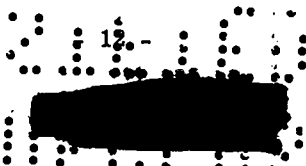

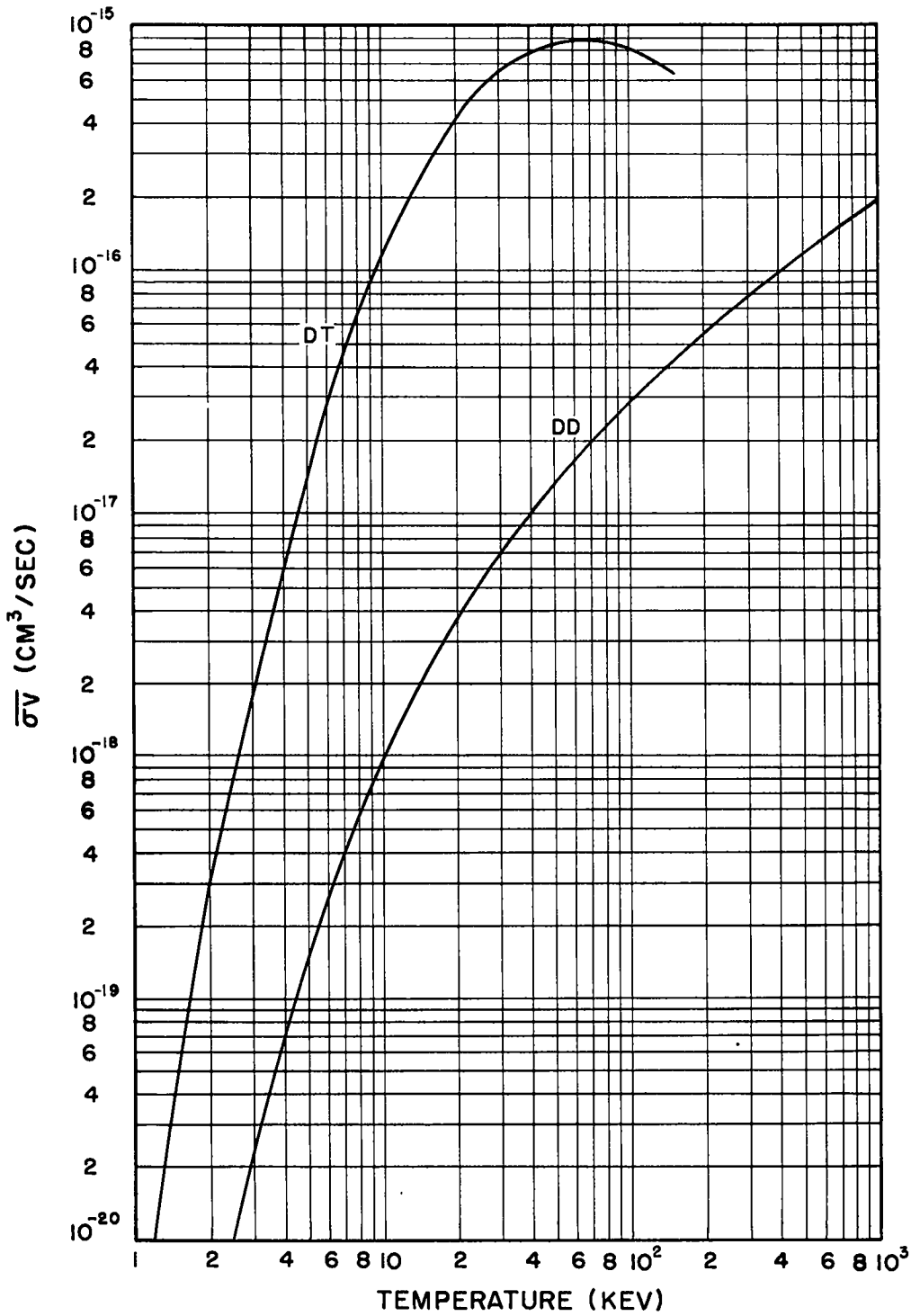

Fig. 3  $\overline{\sigma v}$  for DD and DT reactions as a function of temperature.



The relatively larger value of  $\overline{v}$  at a given temperature  $T$  kev, as compared with  $\overline{v}$  for nuclei all of which have energy  $T$  kev, as derived from Fig. 2, is attributed to the significant contribution of the high-energy portion or "tail" of the Maxwell distribution curve. At temperatures in the vicinity of 5 kev, for example, the maximum contribution to the value of  $\overline{v}$  comes from deuterium nuclei having energy of about  $3T$ , i. e., approximately two or three times the average energy.

In a system of particles in which there is a Maxwellian distribution of the energy, the great majority of particles have energies in the vicinity of the average value. However, there are appreciable numbers of particles with energies greatly in excess of the average. Since both the cross sections of the DD and DT reactions and the relative velocities of the nuclei increase with increasing energy, the high-energy particles make a very substantial contribution to the total  $\overline{v}$ , in spite of their small proportion. The net result is that the average value, i. e.,  $\overline{v}$ , is much greater than that due to nuclei having the average energy at the given temperature.

#### Rate of Thermonuclear Energy Release

If  $\epsilon$  ergs is the average energy produced per nuclear interaction, then it follows from equation (3) that in a thermonuclear DT system

$$\text{Rate of energy release} = \epsilon N_d N_t \overline{v} \text{ ergs per cm}^3 \text{ per sec,} \quad (7)$$

where  $N_d$  and  $N_t$  are the numbers of deuterons and tritons per  $\text{cm}^3$ , respectively, and  $\overline{v}$  is the appropriate value at the temperature of the system, assuming that a Maxwellian distribution is maintained. Similarly, for a DD system,

$$\text{Rate of energy release} = 1/2 \epsilon N_d^2 \overline{v} \text{ ergs per cm}^3 \text{ per sec.} \quad (8)$$

Disregarding the energy carried off by neutrons,  $\epsilon$  for the DT reaction is 3.5 Mev, i. e.,  $3.5 \times 1.6 \times 10^{-6}$  erg. For the two DD reactions, including the associated DT reaction, the average energy release is 4.2 Mev per DD interaction, so that in this case  $\epsilon$  is  $4.2 \times 1.6 \times 10^{-6}$  erg.

By means of equations (7) and (8), together with the values of  $\epsilon$  given above and the data in Fig. 3, it is possible to calculate the rates of energy release associated with the thermonuclear DD and DT reactions. The results for two systems containing  $1.45 \times 10^{15}$  nuclei per  $\text{cm}^3$ , either of deuterium alone or of a mixture of deuterium and tritium, are plotted in Fig. 4 as a function of temperature. It may be mentioned that the nuclear density chosen corresponds to a pressure of 0.020 mm of mercury at  $0^\circ\text{C}$ , but at temperatures of thermonuclear interest, e. g., about 20 kev ( $2.3 \times 10^8$  degrees K), the pressure would be nearly 100 atm.





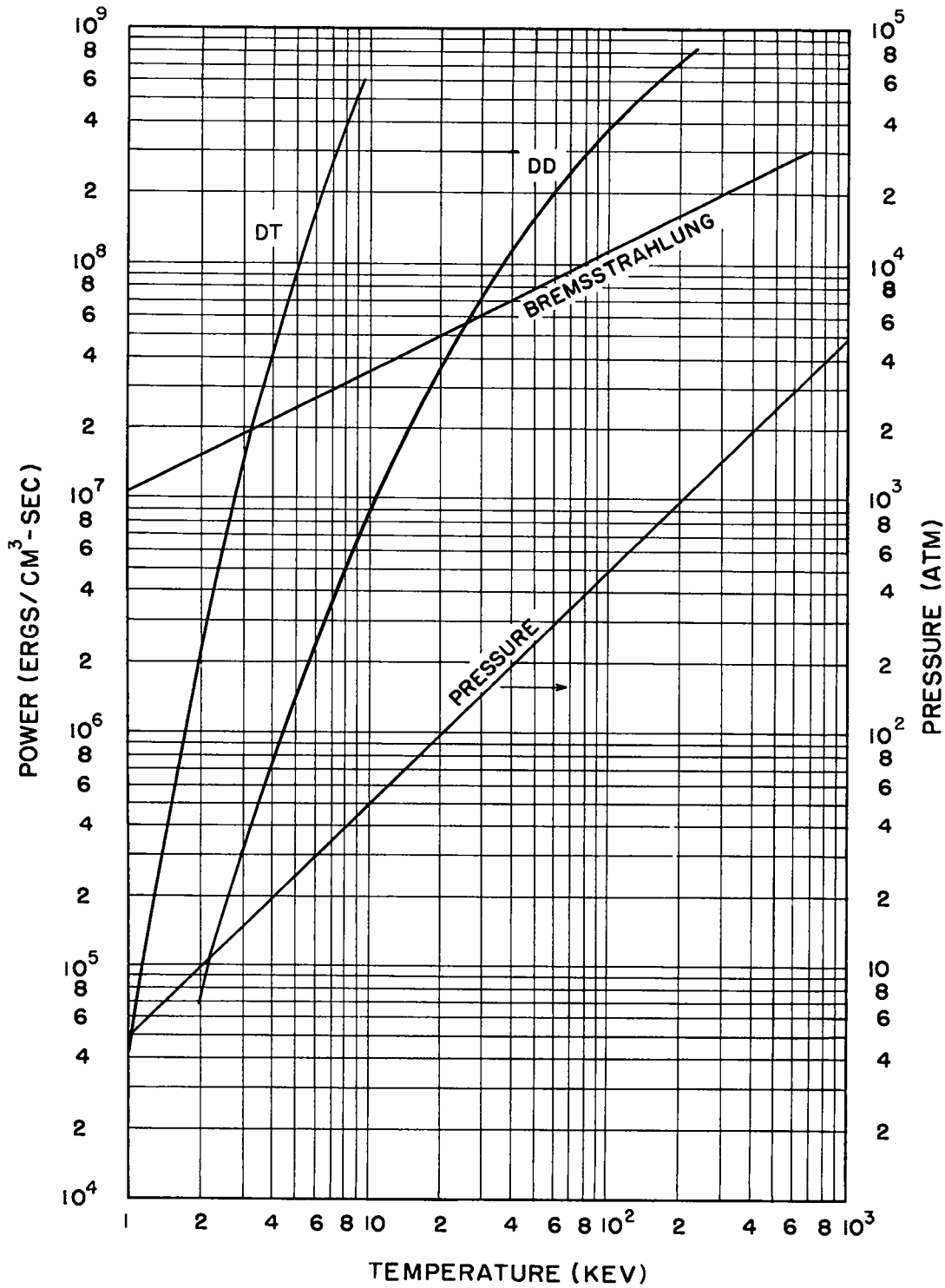



Fig. 4 Energy release from DD and DT reactions as a function of temperature.



Loss of Energy as Radiation

In addition to the probable loss of energy from the thermonuclear system due to the escape of neutrons, for which allowance was made above, energy will be lost in the form of radiation. At temperatures in the region of 10 kev (and even considerably less), the deuterium is present as individual nuclei and electrons. The electrons, accelerated by collisions with nuclei, subsequently radiate energy, but equilibrium of the system with radiation would require an enormous volume (or extremely high pressure) of deuterium. This is the case because of the small cross section for the interaction (absorption) with the radiation produced. Consequently, a considerable amount of energy escapes as radiation, mostly in the form of bremsstrahlung, i. e., radiation with a continuous spectrum mainly in the (low energy) x-ray region. The bremsstrahlung are believed to be the most important source of radiation energy loss from a thermonuclear system.

It can be shown, by means of wave mechanics, that the rate of energy loss as radiation from a completely ionized gas is given by

$$\text{Rate of energy loss} = 4.84 \times 10^{-24} Z^2 N N_e T^{1/2} \text{ ergs per cm}^3 \text{ per sec,} \quad (9)$$

where  $N$  and  $N_e$  are the numbers of nuclei (atomic number  $Z$ ) and of electrons, respectively, per  $\text{cm}^3$ , and  $T$  is the temperature in kev.\* For a thermonuclear system involving nuclei of hydrogen isotopes only,  $Z$  is 1 and  $N$  and  $N_e$  are equal, so that equation (9) reduces to

$$\text{Rate of energy loss} = 4.84 \times 10^{-24} N^2 T^{1/2} \text{ ergs per cm}^3 \text{ per sec,} \quad (10)$$

where  $N$  is the number of hydrogen isotope nuclei per  $\text{cm}^3$ . Taking  $N$  as  $1.45 \times 10^{15}$  nuclei per  $\text{cm}^3$ , as before, the rates of energy loss as bremsstrahlung have been calculated for various temperatures and the results included in Fig. 4.

The energy emitted as radiation may be lost as far as maintaining the temperature in the thermonuclear reacting system is concerned, but it will not be a complete loss. The distribution of the bremsstrahlung as a function of photon energy decreases with increasing energy, and most of the photons have energies much less than  $T$  kev, where  $T$  is the temperature of the system. However, at temperatures of thermonuclear interest, e. g., about 20 to 30 kev, the bremsstrahlung are mostly soft x-rays which would be absorbed in thin layers of matter, e. g., the innermost layers of the walls of the containing vessel. The bremsstrahlung would thus deposit most of their energy as heat and very little would actually escape. Shielding of operating personnel from the bremsstrahlung would be no problem, but the effects of local

\* F. Heitler, "The Quantum Theory of Radiation," 1954, Chapter V, see also, L. Spitzer, Jr., "Physics of Fully Ionized Gases," 1956, p. 88.



heating would have to be considered.

#### Thermonuclear Ignition Temperatures

The minimum requirement for a sustained thermonuclear reaction is that the energy released in the nuclear interactions shall be at least equal to that lost as radiation. It is seen from Fig. 4 that the curve for the loss as bremsstrahlung intersects the DT and DD curves at 3.2 and 26 kev, i. e.,  $4 \times 10^7$  and  $3 \times 10^8$  degrees K, respectively. These temperatures are sometimes called the "ideal ignition temperatures." They are the lowest temperatures at which the thermonuclear reactions could maintain themselves, without supplying energy from outside. Due to heat losses by conduction, which have not been included in the calculations, the actual minimum ignition temperatures would be greater than the "ideal" values.

Since the ignition temperatures are in the vicinity of  $10^8$  degrees K, they are several orders of magnitude higher than those usually encountered in the laboratory. It may be noted, too, that the temperature at the center of the sun is about  $2 \times 10^7$  degrees K and the maximum temperature in a nuclear fission explosion is close to  $10^8$  degrees K. The attainment of temperatures of the order of  $10^8$  degrees, at which controlled thermonuclear reactions would be self-sustaining, thus seems to require unconventional methods of heating.

Although the ideal ignition temperatures derived above were for a density of  $1.45 \times 10^{15}$  nuclei per  $\text{cm}^3$ , the values are independent of the density. This is because the rates of energy production by thermonuclear reaction, and of energy loss, by radiation, are each proportional to  $N^2$ . Hence, any change in the nuclear density will change both rates to the same extent.

It is of interest to estimate the gas pressures, at various temperatures (in the kev region), corresponding to the postulated nuclear density of  $1.45 \times 10^{15}$  nuclei per  $\text{cm}^3$ . The results are shown in Fig. 4, the pressure ordinates being at the right of the figure. At a temperature of 20 kev, the pressure would thus be about 100 atm, as stated above. If the apparatus in which the controlled thermonuclear reaction is proceeding is such that the pressure (or a substantial part of it) is transmitted to the walls, it will be necessary to make sure that it has sufficient mechanical strength.

#### Atomic Numbers and Radiation Loss: Effect of Impurities

It was seen earlier that, because of the increased electrostatic repulsion of the nuclei, thermonuclear reactions involving species with atomic numbers greater than unity were likely to be too slow to be of any practical value. There is another reason why such reactions appear to be of no interest for the controlled release of thermonuclear energy. According to equation (9), the rate of energy loss as bremsstrahlung increases in proportion to  $Z^3$ , since



$N_e$  is equal to  $ZN$  in a completely ionized gas. At the same time, the rate of energy production would decrease, because of the considerably lower values of  $\sigma v$  (and of  $\overline{\sigma v}$ ). Consequently, the ideal ignition temperatures for reactions involving nuclei with  $Z > 1$  would be much higher than for those between hydrogen isotopes.

The presence of impurities of moderate or high atomic number can cause a marked increase in the energy loss by radiation. Consider a mixture containing  $N$  nuclei per  $\text{cm}^3$  of hydrogen isotopes ( $Z = 1$ ) and  $N_i$  nuclei per  $\text{cm}^3$  of an impurity of atomic number  $Z_i$ . The number of electrons is then  $N + Z_i N_i$  per  $\text{cm}^3$ . The rate of energy loss as radiation due to interactions between the electrons and hydrogen nuclei is proportional to  $NN_e$ , i. e., to  $N(N + Z_i N_i)$ . Similarly, the loss resulting from interactions between electrons and impurity nuclei is related to  $Z_i^2 N_i N_e$ , i. e., to  $Z_i^2 N_i (N + Z_i N_i)$ . The total rate of energy loss is thus proportional to  $(N + Z_i^2 N_i)(N + Z_i N_i)$ . In the absence of impurity, the radiation energy loss in a hydrogen isotope reaction is dependent upon  $N^2$ , as seen in equation (9). It follows, therefore, that

$$\frac{\text{Energy loss in presence of impurity}}{\text{Energy loss in absence of impurity}} = \frac{(N + Z_i^2 N_i)(N + Z_i N_i)}{N^2}$$

Suppose, for example, that the impurity is oxygen ( $Z = 8$ ), and that it is present to the extent of 1 nucleus per 100 nuclei of hydrogen isotopes, i. e.,  $N_i/N$  is 0.01. It is found that

$$\frac{\text{Energy loss in presence of impurity}}{\text{Energy loss in absence of impurity}} = 1.77.$$

In other words, the presence of 1 percent of oxygen impurity will increase the energy loss as bremsstrahlung by 77 percent. For impurities of higher atomic number, the increase in the energy loss would be even greater.

This result points up the very great importance of keeping out even traces of impurities, especially those of moderate or high atomic numbers, from the gases to be used in a controlled thermonuclear reaction system. By increasing the rate of energy loss as radiation, such impurities will have the effect of increasing further the already high ignition temperatures.

#### Confinement of Plasma

In considering the nature of the apparatus which might be used for a controlled thermonuclear reaction, it is immediately obvious that the gas at extremely high temperature must be kept away from the walls of the vessel. Thus, confinement of the reacting medium is an important problem. A nucleus at high temperature (high energy) striking a wall will impart much of its energy to the wall. Not only does this represent a loss of energy to the reacting



system, but the temperature of the vessel material may be raised sufficiently to convert it into vapor. All known substances vaporize at temperatures below 0.5 ev, and this is very low in comparison with thermonuclear temperatures.

At the particle densities which seem practical at present, e.g., about  $10^{15}$  nuclei per  $\text{cm}^3$ , the reaction mean free path of a deuterium (or tritium) nucleus, which is equal to  $1/N\sigma$ , is very large, possibly  $10^{12}$  cm or more. In a vessel of reasonable size, therefore, a deuterium nucleus, with a speed approaching  $10^8$  cm per sec, will strike the containing walls many times, on the average, before it interacts with another nucleus. The probability of energy loss to the walls is thus very great. The number of wall collisions relative to the reaction frequency would be decreased by increasing the nuclear density. But at temperatures of the order of 10 kev (about  $10^8$  degrees K), it is doubtful whether a significant increase in density would be feasible unless the particles were kept away from the walls of the vessel.

At temperatures greater than 0.1 kev (about  $10^6$  degrees K), deuterium and tritium are completely ionized, so that the reacting gas consists entirely of nuclei and electrons. This is generally referred to as a "plasma" of electrically charged particles. It would seem, therefore, that confinement at high temperatures might be achieved by the use of electrical or magnetic fields. Since electrical fields tend to move positive and negative charges in opposite directions, prevention of access of charged particles to the walls appears to be unlikely in the absence of large space charge effects. The use of magnetic fields is, therefore, the only promising method known at present for confining the plasma.

In a magnetic field, a charged particle will execute circular paths in a plane normal to the field direction. For a particle carrying a unit charge, e.g., a hydrogen isotope nucleus or an electron, the radius of gyration,  $r$ , is given by

$$r = \frac{mvc}{eH},$$

where  $m$  is the particle mass,  $v$  is its velocity perpendicular to the field direction,  $c$  is the velocity of light,  $e$  is the electronic charge, and  $H$  is the magnetic field strength. At a temperature of 20 kev, the average velocity of a deuteron in any given direction is about  $10^8$  cm per sec; hence, assuming a magnetic field of 100,000 gauss, the radius of the circular path of the deuteron about the lines of force is about 0.2 cm. For an electron, the radius of gyration is appreciably smaller. Consequently, there is a reasonable prospect for the confinement of a plasma, consisting of deuterons and electrons, by means of a strong magnetic field.

A rough, order-of-magnitude, estimate of the minimum field strength necessary for confinement may be made in the following manner. Consider the idealized case in which the plasma is bounded by an imaginary surface, so that the particle density on one (the wall) side

is zero and that on the other side is uniform, e. g.,  $n$  particles per  $\text{cm}^3$ . The pressure difference between the two sides of the plasma would thus be  $nkT$ , i. e.,  $nT$  kev per  $\text{cm}^3$  if  $T$  is expressed in kev. This pressure difference must be balanced by the pressure due to the magnetic field, the maximum possible value of which is  $H^2/8\pi$  for a field of strength  $H$  at the wall. It follows, therefore, that

$$\frac{H^2}{8\pi} \geq nT. \quad (11)$$

If the nuclear density of the plasma is  $1.45 \times 10^{15}$  per  $\text{cm}^3$ , as used in earlier calculations, the total particle density,  $n$ , is twice this value, i. e.,  $2.9 \times 10^{15}$  per  $\text{cm}^3$ , since there is one electron for each hydrogen isotope nucleus. Taking the temperature as 20 kev, i. e.,  $20 \times 1.6 \times 10^{-9} = 3.2 \times 10^{-8}$  ergs, it follows that

$$H \geq 50,000 \text{ gauss,}$$

at temperatures of thermonuclear interest.

Since  $H$  increases with  $n^{1/2}$ , it is seen that stronger magnetic fields would be required to contain the plasma if the nuclear density were increased above the value of  $1.45 \times 10^{15}$  per  $\text{cm}^3$  postulated above. If the high-temperature plasma can be kept away from the walls of the vessel, higher densities are possible. In the special case of the pinch effect, referred to below, in which the plasma is compressed by a self-magnetic field, the plasma is not supported by the walls and the particle density may attain something of the order of  $10^{18}$  per  $\text{cm}^3$ . In these circumstances, magnetic field strengths of hundreds of kilogauss are required.

Two general methods for using a magnetic field for confining a plasma have been considered. In the first, a self-magnetic field is produced by a current inside a tube containing the plasma (Fig. 5A). In the second method, a magnetic field is produced by an electric current outside the tube (Fig. 5B). Both kinds of magnetic fields are being used in experiments designed to explore the feasibility of controlling thermonuclear reactions, as will be described later. However, in each case the plasma has certain elements of instability, and it appears that a suitable combination of the two types may prove successful in confining a stable plasma.

In Figs. 5A and 5B the containing vessel is shown for simplicity as a straight cylinder, but this may equally well be regarded as part of an endless tube, such as a torus. A basic requirement is that the lines of force of the magnetic field should everywhere be parallel to the walls. If the lines of force impinge on the walls, the plasma will obviously not be confined.

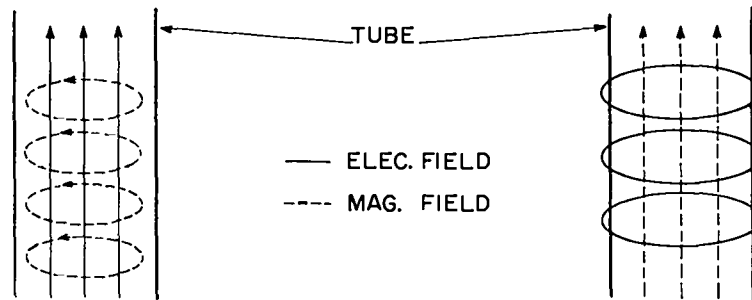

Fig. 5A

Fig. 5B

#### Heating the Plasma

If the control of thermonuclear reactions proves possible, then, once the process has been initiated, the heat produced will be at least sufficient to maintain the temperature for the reaction to proceed continuously. Any excess energy released will be drawn off and utilized in some manner. However, there still remains the problem of devising methods for initiating the reaction by raising the temperature to the appropriate ignition point, e.g., 26 kev for deuterium.

The use of sparks and electrically exploded wires has been proposed for initiating thermonuclear reactions. In these cases, electrons at high temperature (high kinetic energy) would be injected into the gas. The energy must then be passed on to a deuterium nucleus in order to raise its temperature. Because of the large ratio of the masses of the deuteron and the electron, the fraction of energy transferred per collision is very small. Calculations indicate that no appreciable local rise in temperature of the deuterium can be attained before the high-energy electrons are dispersed over a large volume. The injection of accelerated nuclei (positive ions) of high energy may prove more effective than electrons. The possibility of introducing impurities of moderate or high atomic number, from materials used as electrodes or conductors, must be borne in mind.

Suggestions have been made for the production of high temperatures by shock heating or by means of colliding jets. The essential problem here is one of attainment of high velocities, e.g., of a piston or a jet of gas. The velocities required are so high, namely, about  $10^8$  cm per sec, that they do not seem to be capable of realization under such conditions that a controlled thermonuclear reaction will be possible.



The methods for heating the plasma that show most promise are those based on the use of magnetic and electrical fields. For the initial breakdown (or ionization) of the gas, a high voltage is generally used, although the process may be facilitated by an induced radio-frequency field in the early stages. If such a field is used, it causes some heating of the gas, but as the extent of ionization increases, due to the radiofrequency field and collisions of electrons and nuclei with neutral particles, the induced radiofrequency current is forced to the outside of the plasma by the "skin effect." The energy supplied to the plasma in this manner is thus limited and other methods of heating must be employed. Some of the proposals which have been made for this purpose are described below. The various methods can be used singly or in combination with one another.

#### Ohmic Heating

Whether a radiofrequency field is used or not, heating (and ionization) can be produced by means of an electric field or discharge. Electrons will be accelerated in the direction of the field, provided any magnetic field present is either small or is parallel to the electric field. In the early stages, when the extent of ionization of the gas is relatively small, the accelerated electrons will cause further ionization of neutral atoms and molecules by collisions.

Later, when ionization is nearly complete, the energy gained by the electrons can, under appropriate conditions, serve to raise the temperature of the plasma. The requirement is that the energy gained by the electron from the field before it collides with a nucleus should be small in comparison with the kinetic energy of the electron. In other words,

$$eE\lambda \ll 1/2 mv^2,$$

where  $E$  is the electric field strength,  $\lambda$  is the mean free path for collision of an electron with a deuterium nucleus, and  $e$ ,  $m$ , and  $v$  are the charge, mass, and velocity, respectively, of the electron. In these circumstances, the energy gained by the electron from the field goes to increase the temperature of the plasma. The rate of energy absorption is then determined by  $I^2\rho$ , where  $I$  is the induced current and  $\rho$  is the resistivity of the plasma. The heating is thus related to the same parameters as the ohmic heating of a resistance.

It may be mentioned that if the conditions are such that

$$eE\lambda \gg 1/2 mv^2,$$

then the electrons will not be in temperature equilibrium with the deuterium nuclei. The electrons can then acquire very high energies and are said to "run away." This effect has been observed in experimental work on the controlled release of thermonuclear energy.





The disadvantage of ohmic heating of a plasma is that in order to attain very high temperatures, extremely large induced currents would be required. This is so because the resistivity of a highly ionized gas decreases as the temperature is raised. For a completely ionized plasma, theoretical considerations show that the resistivity,  $\rho$ , is independent of the density and is related to the temperature,  $T$ , in kev, by

$$\rho \approx 3 \times 10^{-6} T^{-3/2} \text{ ohm-cm.}^* \quad (12)$$

Thus, at a temperature of 1 kev,  $\rho$  is about  $10^{-6}$  ohm-cm, which is roughly the same as for copper at ordinary temperatures, and it becomes smaller as the temperature of the plasma approaches that required for thermonuclear ignition. However, other methods of heating may be employed to supplement (or replace) ohmic heating at high temperatures.

#### Adiabatic Heating

If a changing magnetic field is applied to the plasma, an electrical field is induced in a perpendicular direction. Charged particles subjected to both fields will be accelerated in their orbits along the electric field and perpendicular to the magnetic field. In addition, they will drift in a direction perpendicular to both fields. The orbital velocity,  $v$ , will change in such a manner that  $v^2/H$  is constant, where  $H$  is the (instantaneous) magnetic field strength. The drift velocity of the centers of gyration of the charged particles is directed radially inward, for both of the geometries shown in Figs. 5A and 5B, and this will result in compression of the plasma.

For the situation shown in Fig. 5B, theory indicates that for each particle  $\pi r^2 H$  is constant, where  $r$  is the radial separation between the center of gyration and the central axis of the system. If the radius of gyration is small, compared to this separation,  $r$  is essentially the radius of the plasma. The volume,  $V$ , of the plasma, which is proportional to  $\pi r^2$ , is thus seen to be inversely proportional to  $H$ , the instantaneous magnetic field strength. In other words, an increase in the magnetic field is accompanied by a decrease in volume. The temperature,  $T$ , of the plasma is then related to the volume by an expression of the form

$$TV^{\gamma-1} = \text{constant}, \quad (13)$$

where  $\gamma$  is 2 if collisions between particles are unimportant.

If the magnetic compression is so slow that collisions play a significant part in bringing about equipartition of energy between transverse and longitudinal degrees of freedom, then  $\gamma$

---

\*See L. Spitzer, Jr. and R. Harm, Phys. Rev., 89, 977 (1953); also L. Spitzer, Jr., op. cit., p. 81.



falls to  $5/3$ . In these circumstances, equation (13) becomes identical with that for the adiabatic compression of an ideal gas. It is for this reason that the description "adiabatic heating" is used.

The effectiveness of adiabatic heating is independent of temperature and is not limited by the skin effect. However, to attain temperatures in the region of 10 kev, very large increases in the magnetic field would be required. It would appear, therefore, that adiabatic heating might be most useful for final stages of the heating, when the temperature of the plasma has already been raised in other ways.

### Collapse Heating

The adiabatic (or reversible) heating described above results from a relatively slow increase in the magnetic field. Heating by collapse, on the other hand, is based on irreversible heating due to sudden generation of a magnetic field. For the conditions of Fig. 5A, the sudden application of an induced electric field will give rise to plasma currents which generate a sudden, compressive magnetic field. In Fig. 6, which represents a section through the geometry of Fig. 5B, a current loop surrounds a tube containing plasma, so that an axial

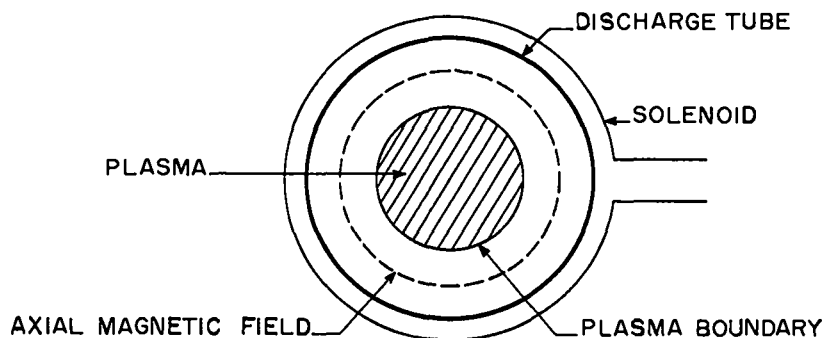

Fig. 6

magnetic field is produced. In either case, the boundary, which theory predicts as existing between the magnetic field and the plasma, can then act as a magnetic piston. If the field is applied suddenly, a magnetic shock develops which heats the plasma in an irreversible manner. The behavior is similar to that of a strong shock in hydrodynamics.

### Heating by Magnetic Pumping

If, in the adiabatic procedure, the magnetic field varies with time in a regular manner, there will be a series of successive compressions and expansions. As a result, there will be no net transfer of energy to the plasma. However, if the pressure and density of the plasma



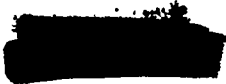

are forced out of phase in some manner, transfer of energy (and an increase in temperature) will result. This is called heating by "magnetic pumping" and can conveniently be achieved by applying the oscillating (radiofrequency) magnetic field at a bulge in the tube (or torus) in which the plasma is being confined. The energy gained by the particles is expected to be proportional to  $(\Delta H/H)^2$ , where  $\Delta H/H$  is the fractional variation of the magnetic field strength.

#### Radiofrequency Heating

Another possibility for increasing the energy of charged particles in a magnetic field is to subject the particles to an electrical field alternating at their gyromagnetic frequency, i. e.,  $eH/2\pi mc$ , where the various symbols have the same significance as before. As the particle gyrates, the velocity and the electrical field are in phase, so that continuous acceleration will result. For electrons in a magnetic field of 100,000 gauss, the gyromagnetic frequency is about  $2.8 \times 10^{11}$  per sec, but this appears to be too high for practical use. For the deuterium nucleus, on the other hand, the corresponding frequency is roughly  $7.6 \times 10^7$  per sec. This is in the radiofrequency region and so is distinctly within the realm of possibility.

The radiofrequency method of heating just described appears to be of special interest at low particle densities. At higher densities it offers somewhat less promise because the highly ionized plasma tends to reflect high-frequency radiation. Sufficient heating of the positive ions (nuclei) might occur at the surface of the plasma, but this has not yet been investigated.

#### Experimental Thermonuclear Studies: Introduction

Three main lines of experimental investigation are in progress for the purpose of obtaining information which it is hoped may lead to the successful realization of controlled thermonuclear reactions. These are (1) the Stellarator program at Princeton, (2) the Mirror Machine program at Livermore and (3) the Pinch Effect program at Los Alamos. Some experiments on the pinch effect are also being carried out at Berkeley and elsewhere. Basically, all that has been attempted so far is to study the possibilities of confining and heating a plasma to high temperatures. Any designs that may have been proposed for utilizing the energy released are purely conceptual. This is so because there are numerous problems yet to be solved before engineering and economic aspects of controlled thermonuclear energy need be given detailed study.

Theoretical considerations show that stable confinement of a plasma is possible in an infinite cylinder, with the magnetic lines of force (from a homogeneous field) parallel to the axis of the cylinder (see Fig. 5B). Since an infinite cylinder is not practical, it might at first appear that the same result could be achieved with an endless tube, such as a torus. But this is not the case. In essence, the reason is that, partly owing to the curvature of the torus, and partly because it varies with distance from the central axis of the torus, the magnetic field is



inhomogeneous. As a result, there is a tendency for the electrons and nuclei to drift in opposite directions. Hence, starting with a uniform plasma in the torus, a separation of charge tends to occur which, in turn, produces an electrostatic field. This field causes a lateral drift of the plasma as a whole, so that contact with the walls of the torus will occur and stable confinement is not possible.

In the "Stellarator" a twisted torus (or figure-8 shaped tube) is used. The magnetic field is produced by passage of an electrical discharge through a coil of wire wound completely around the outside of the tube. The drifts of the charged particles in the opposite ends of the tube then tend to cancel each other out. The behavior is thus equivalent to that in an infinite cylinder, as far as the effect of the external magnetic field on the plasma is concerned.

Another way in which stable plasma might be confined is to use a straight but finite cylinder, with an axial magnetic field from an external source. There is then no problem due to particle drift, but losses from the ends of the finite cylinder become serious. In order to minimize such losses, the magnetic field, while remaining axially symmetric, is greatly increased at the ends, so that the charged particles are reflected back (and compressed) into the plasma. This is the underlying concept of the "Mirror Machine."

A third method for the confinement of plasma differs from those described above in the respect that an internal magnetic field, produced either by an electrical discharge or by currents induced in the plasma from outside, is used (see Fig. 5A). Due to the magnetic attractions between parallel elements of the current, there is a tendency for the discharge (and its associated self-magnetic field) to contract. This phenomenon, predicted theoretically and later confirmed by experiment, is called the "pinch effect." Since the charged particles will tend to gyrate about the lines of force, the contracting field should serve to confine the plasma and keep it away from the walls of the containing vessel. A striking example of a pinch, formed by passing an electrical discharge through argon at 30 microns pressure, is seen in Fig. 7. The spiral conductor surrounding the discharge tube is for the application of a radiofrequency field for initial ionization.

An interesting possibility arising from the compression of plasma by a changing or pulsed field, as in the Mirror Machine and in a pinched system, is that thermonuclear energy might be directly converted into electrical energy. Suppose the confining field is produced by discharging condensers through wires paralleling the tube (or torus) containing the gas. Each condenser discharge will then produce a transient gas discharge. When the external field ceases to change or changes in the opposite direction, the pinched plasma will expand. As a result, it will cool adiabatically, as well as by radiation loss, and the thermonuclear reactions will stop. However, at this time, the expansion of the electrically charged plasma will cause



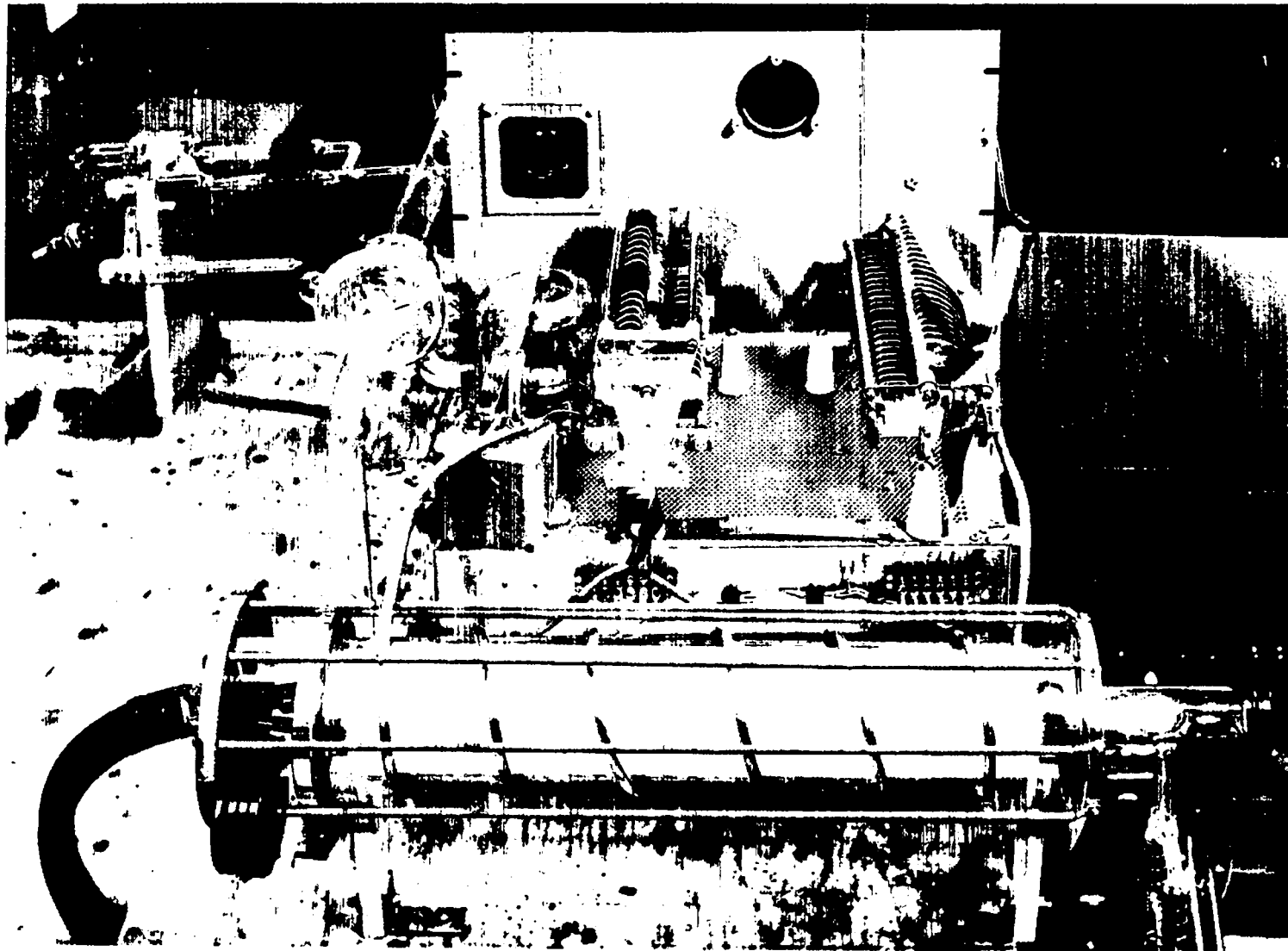

Fig. 7 Pinch formed by passing an electrical discharge through argon at 30 microns pressure.



energy to be transferred from the plasma to the external circuits producing the current in the plasma. Thus an electric current will now be produced in the external circuit.

#### The Pinch Effect: Pinch Current

The controlled thermonuclear studies at Los Alamos are based on the application of the pinch effect to confine and compress the plasma. Before proceeding to describe some of the experiments made to study the pinch phenomenon, consideration will be given to the general magnitude of the current that might be needed to initiate thermonuclear reaction. To simplify the calculations, suppose that the plasma is contained in a cylindrical vessel of infinite length. Let  $r$  be the radius of the confined (or pinched) plasma; within this region the particle density may be assumed uniform, whereas outside it may be taken to be zero. In this ideal case, the magnetic field would vanish inside the plasma and would have a value  $I/5r$  outside, where  $I$  is the total stream current in the plasma, i. e.,  $H = I/5r$ . Utilizing the relationship of equation (11), it follows that

$$\left(\frac{I}{5r}\right)^2 \frac{1}{8\pi} \approx NkT$$

or

$$I^2 \approx 200 \pi r^2 NkT.$$

If  $T$  is in kev, which is also the value of  $kT$  in kev, it is necessary to multiply by  $1.6 \times 10^{-9}$  to convert to ergs; hence, replacing  $\pi r^2$  by  $A \text{ cm}^2$ , the cross-sectional area of the pinched plasma, it follows that

$$I_{\text{amp}}^2 \approx 3.2 \times 10^{-7} ANT, \quad (14)$$

where  $I$  is in amperes.

Consider a plasma confined in a tube of  $100 \text{ cm}^2$  cross section, i. e.,  $A = 100 \text{ cm}^2$ , with a particle density before pinching, i. e.,  $N$ , equal to  $2 \times 10^{15}$  per  $\text{cm}^3$ , so that  $AN$  is  $2 \times 10^{17}$  particles per cm. Since  $AN$ , the number of particles per unit length, is not altered by constriction of the plasma in the pinch, this value may be inserted in equation (14). The values for the total stream current calculated in this manner for three temperatures are as follows:

Temperature (kev)	1	10	50
Current (amps)	$2.5 \times 10^5$	$8 \times 10^5$	$1.8 \times 10^6$

It is seen therefore, that very large induced currents are required, although the power expenditure needed to maintain these currents may not be excessive.



  
The Perhapsatron

The first apparatus used at Los Alamos for studies of the pinch effect was called the "Perhapsatron." In one of its later forms, it consists of a toroidal, Pyrex tube, about 70 cm major diameter and 7 cm minor diameter. This contains the gas at low pressure in which current is induced. The toroidal tube is linked through a laminated transformer core, to provide magnetic induction, to the primary (Fig. 8). Originally, the primary consisted of two 16-turn coils in parallel wound around the major circumference of the torus, but well separated from the secondary discharge path. This separation was intended to reduce magnetic interactions between primary and secondary discharge currents. Better cancellation of magnetic effects was obtained, however, by cementing the primary windings to the outer surface of the tube in a symmetrical arrangement of two 4-turn coils in parallel. Subsequently, a single turn of copper braid, which completely enclosed the toroidal tube, was used as the primary winding. (Still later, this was replaced by a spun copper conductor in two parts, an upper and a lower, with a gap between to eliminate eddy currents when a longitudinal magnetic field was applied to stabilize the pinched discharge.)

The primary is energized by means of a pulsed discharge from a bank of 38 condensers, each of 1  $\mu$ f capacity. Every condenser has its own coaxial cable, to reduce feed line inductance (see Fig. 8); these cables are connected to a spark gap seen in the center of the torus, for switching the condenser discharge to the transformer primary. The condensers can be charged up to 20 kv, and a potential gradient of about 100 volts per cm can be obtained in the discharge path. Under these conditions, secondary currents approaching 50,000 amps have been observed in deuterium gas at low pressure.

The initial ionization of the gas (about 0.01 percent) in the toroidal tube is accomplished by means of a high-frequency discharge. This is supplied from a radiofrequency oscillator capable of delivering power up to 500 watts at frequencies of 27 megacycles per sec. The oscillator is connected to electrodes, as shown in Fig. 9, located on the outside of the gas entry and exit tubes. The condensers which supply the primary discharge are connected through a spark gap in the manner indicated, to the conductor surrounding the torus.

The first definite pinches obtained in the Perhapsatron were observed optically with krypton, from which the light emitted is brighter than with deuterium. Subsequently, pinches were obtained in ordinary hydrogen, deuterium, and helium. There is evidence that compressions in the pinch of 30 or more have been realized, and although no particular attempt was made to obtain high temperatures, a temperature of about 50 ev was attained as a result of ohmic heating and compression of the plasma in the pinched discharge.

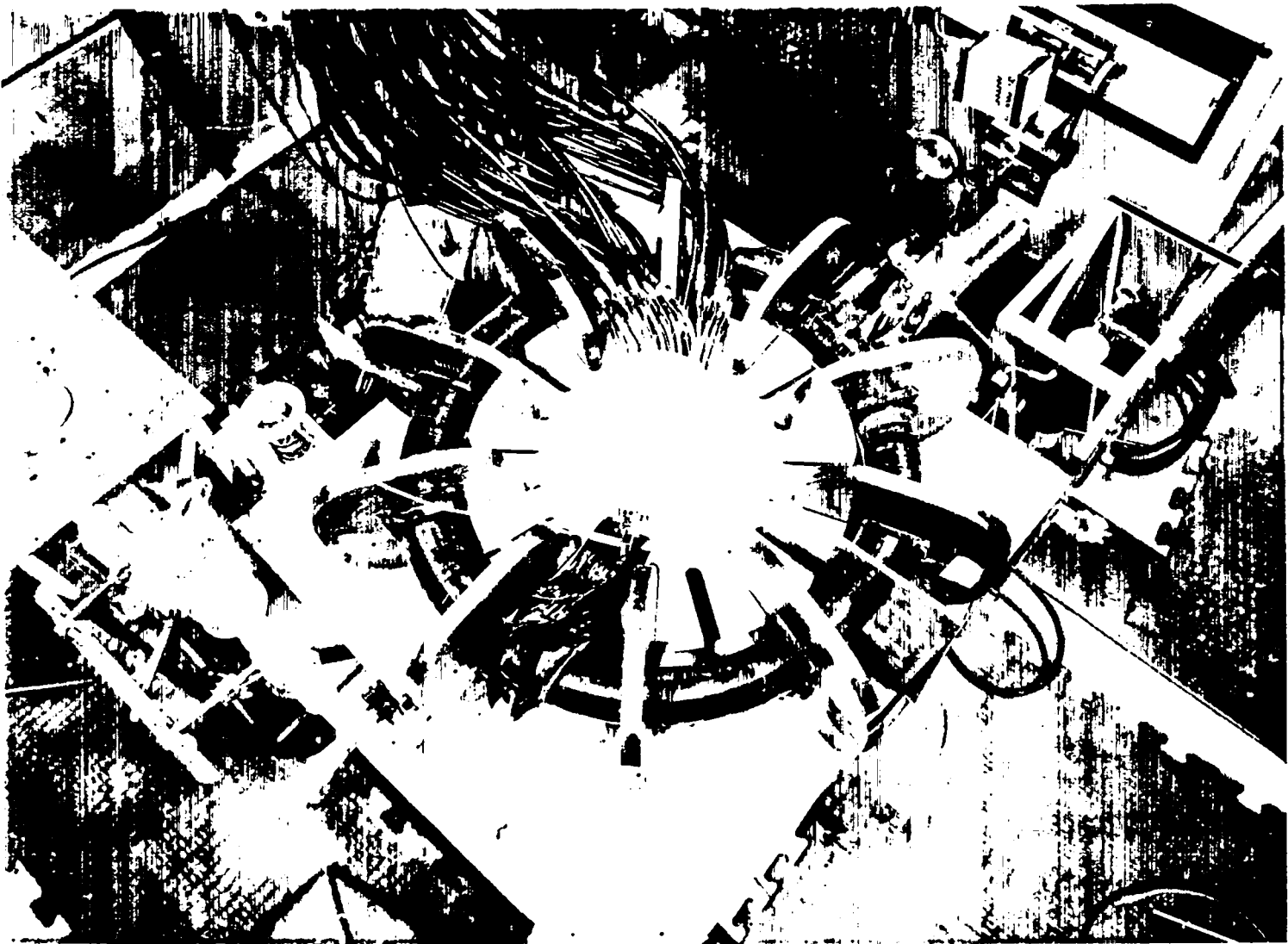
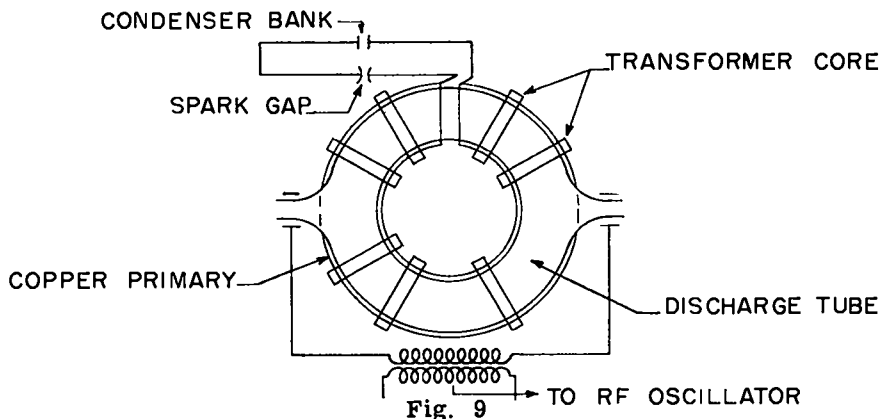

Fig. 8 The Perhapsatron.





### Plasma Instability

The early studies of the pinch effect showed, in agreement with theoretical prediction, that the pinched discharge was unstable. In krypton, for example, at a pressure of 0.03 mm of mercury and a field of 20 volts per cm, the pinch was observed to form within 5 microseconds, and to remain sharp for about an equal length of time. Then uneven waves (or turbulence) developed in the discharge which almost filled the tube again within the next 10 microseconds or so. Although this instability would not preclude the alternate formation of the pinch and its breakup in a regularly pulsed system, it is doubtful whether the period of stability in the Perhasatron was sufficient to permit a reasonable amount of thermonuclear reaction to occur.

A theoretical treatment of the pinched discharge shows that it is subject to what is often called "kink" instability.\* The physical basis of this phenomenon is somewhat as follows. As long as the pinch is stable, it will consist essentially of a straight-walled (or uniformly curved) cylinder. Suppose, however, that a bend (or kink) develops, perhaps as the result of a slight asymmetry in the induced current. The situation will then be as represented in Fig. 10. The lines of force of the self-magnetic field are brought closer together on the inside and are farther apart on the outside of the bend. As a result, the magnetic pressure is greater on the inside, and there is a net force which acts in such a direction as to increase the bend. Thus, once a slight kink develops, it will grow in size until the pinched discharge breaks up and the plasma fills the tube.

The amplitude of the wave (or kink) increases exponentially, with an e-folding time approximately equal to the time required for a sound wave to travel the distance of a wave length of the instability. Thus, small waves will increase in amplitude faster than large ones.

\* See, for example, M. Kruskal and M. Schwarzschild, Proc. Roy. Soc., A223, 348 (1954).



At high temperatures, in the kev range, the velocity of sound is so great, e.g.,  $10^7$  to  $10^8$  cm per sec, that the kink amplitude increases very rapidly. For example, at 10 kev temperature, a wave length of 1 cm will increase its amplitude by a factor of e in  $0.01 \mu\text{sec}$ .

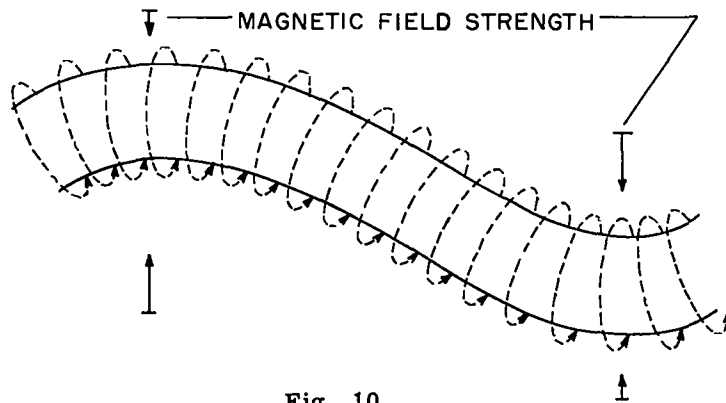

Fig. 10

Another type of instability is believed to exist in certain cases of a plasma confined by a magnetic field; it is called "sausage-type" instability when it occurs with a magnetic field due to an internal current (Fig. 5A) and "flute" instability when an external current is involved (Fig. 5B). The nature of this instability may be illustrated by means of Fig. 11, which represents a section through a tube of circular cross section for the geometry of Fig. 5B, so that the direction of the field is perpendicular to the plane of the paper. It is felt that there is an inherent tendency for the plasma to slip out through the containing lines of force, and as a result a wave-like displacement may occur, as shown in Fig. 11. The appearance of the plasma surface would then be something like the flutes on a column. The magnetic field strength is greater in the valley than at the peaks of the wave, so that the displacement tends to increase, thus leading to instability of the confined plasma. The e-folding time for flute

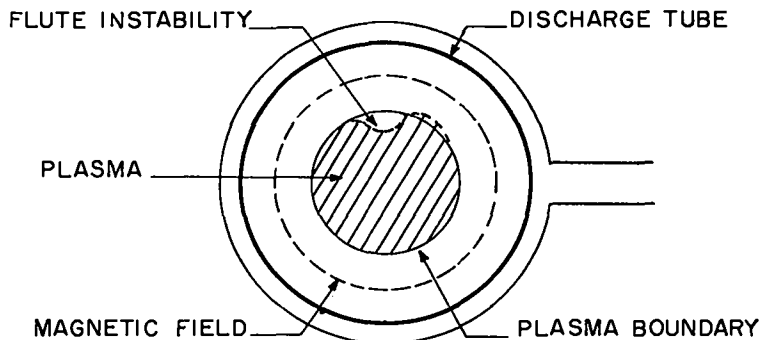
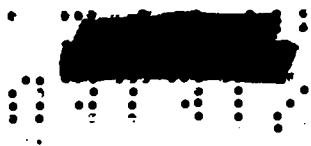

Fig. 11





instability is probably of the order of a microsecond.

When the conditions are equivalent to those in Fig. 5A, as in the pinch effect, the phenomenon referred to above would cause constriction of the plasma at certain points, as shown in Fig. 12. This is called sausage-type instability because it would give the plasma the appearance of links in a chain of sausages. Although there is yet no absolute proof that this

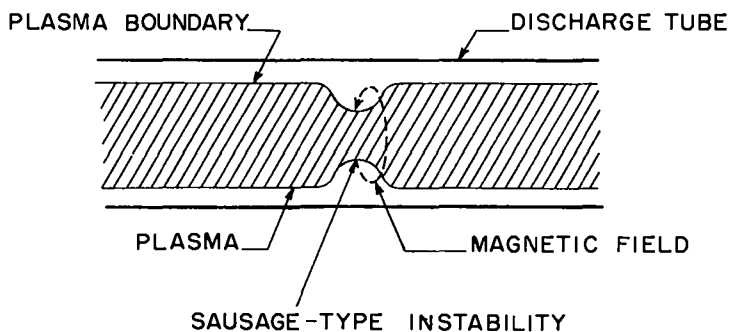

Fig. 12

type of instability actually arises in a pinched system, there is indirect evidence of its occurrence.

There are two possible ways in which plasma instability may be overcome in the utilization of the pinch phenomenon in thermonuclear reactions. One is to adjust the conditions so that the temperature of the plasma is increased very rapidly, thus permitting appreciable thermonuclear interaction during the short period in which the plasma is highly pinched. The second is to find means of stabilizing the pinch so that it will persist for longer periods than a few microseconds. Investigations along both of these lines are proceeding at Los Alamos.

#### Columbus Devices

The general name "Columbus" has been given to devices in which an impulsive, straight pinch, having a short period of persistence, is produced. By the development of a very powerful discharge, it is hoped that temperatures of thermonuclear interest can be attained before the pinch breaks up. During this period it might be possible to obtain enough thermonuclear energy to repay the cost of producing the pinch.

The several forms of Columbus at Los Alamos have been designed to take advantage of some of the conclusions of the "Infinite Conductivity Theory" of the pinched discharge, usually referred to as M (for motor) theory.\* According to this theory, there is, on the outside of

\* So called because of certain resemblances to the theory of the electric motor (see LA-1850).



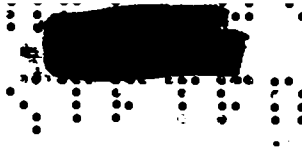

the confined plasma, a thin sheath (or surface layer) of current which moves inward at a velocity,  $v$ , given by

$$v = 4 \sqrt{\frac{c^2 E^2}{4\pi\rho}}, \quad (15)$$

where  $c$  is the velocity of light,  $E$  is the field strength, and  $\rho$  is the density of the plasma at any instant. As the current sheath moves toward the center, it strikes the nuclei and electrons present in the plasma, thereby transferring energy to them.

At each collision with the moving sheath, a particle, having a small initial velocity, will be reflected back with a velocity equal to twice that of the imploding sheath, i. e.,  $2v$ . The kinetic energy thus gained by a particle of mass  $m$  is then

$$\text{Kinetic energy} = \frac{1}{2} m(2v)^2.$$

Since the mass of a deuterium nucleus is some 3,500 times as great as that of an electron, it is apparent that essentially all the energy derived from the imploding sheath will be transferred to the nuclei and very little to the electrons. This is a desirable situation from the thermonuclear standpoint since it minimizes radiation losses while the plasma is being heated. The temperature of the nuclei can obviously be increased by increasing  $v$ , and equation (15) shows that one way in which this can be achieved is by making the field strength as large as possible.\*

The efficiency of the system depends upon the ratio of the thermonuclear power output to the power input for heating the plasma in the manner just described. According to equation (8), the power output per  $\text{cm}^3$  would be proportional to  $N^2 \bar{\sigma v}$ , where  $N$  is the number of deuterium nuclei per  $\text{cm}^3$  in the pinched plasma. If  $A$  is the cross-sectional area of the plasma, the power output is proportional to  $AN^2 \bar{\sigma v}$  per cm. Let  $A_0$  and  $N_0$  represent the initial cross-sectional area of the plasma (or gas) and the density, respectively; then  $A$  is equal to  $A_0/C$  and  $N$  to  $CN_0$ , where  $C$  is the compression of the plasma. Since the energy output is equal to the product of power and time, it follows that

$$\text{Thermonuclear energy output} \propto \frac{A_0}{C} (CN_0)^2 \bar{\sigma v} \tau, \quad (16)$$

where  $\tau$  is the time the pinch stays together. The duration of the pinch may be taken as roughly proportional to the pinch radius divided by the velocity of sound at the existing

\*This method of heating has features in common with that described earlier as shock heating due to "collapse".

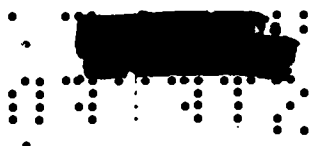

temperature. If  $R$  is the radius of the discharge tube, the pinch radius is  $R/C^{1/2}$ ; further, the velocity of sound is proportional to  $T^{1/2}$ , so that

$$\tau \propto R/C^{1/2} T^{1/2}$$

Since  $\bar{v}$  varies approximately as  $T^{5/2}$ , equation (16) may be written as

$$\text{Thermonuclear energy output} \propto A_0 C^{1/2} N_0^2 T^2 R.$$

The energy input per cm is proportional to the total number of nuclei per unit length and their average kinetic energy (or temperature); hence,

$$\text{Energy input} \propto A_0 N_0 T$$

The ratio of energy output to energy input is thus given by

$$\frac{\text{Energy output}}{\text{Energy input}} \propto C^{1/2} N_0 T R.$$

The efficiency of the system may thus be expected to increase with the degree (or compression) of the pinch, the initial nuclear density, the plasma temperature, and the radius of the tube.

The basic purpose of Columbus was to see if sufficiently high temperatures for thermonuclear reaction could be produced in a pinch of short duration by the use of much stronger fields than those employed in the Perhasatron. It was considered simpler to apply these fields directly across a straight tube with electrodes at the ends (Fig. 13), rather than inductively. It was realized that the electrodes would undoubtedly perturb and contaminate the plasma

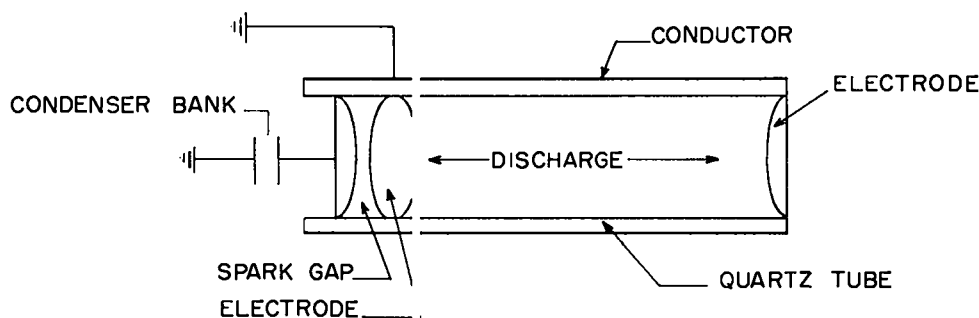
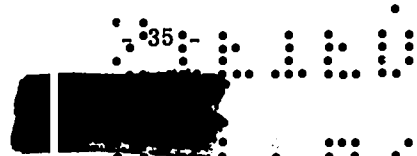
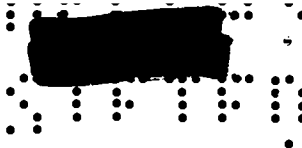

Fig. 13

in their vicinity, but it was felt that in the short time of interest, i. e., about a microsecond, this would not affect the center region of the discharge upon which observations were being made.





In the first Columbus model (Columbus I), the straight, Pyrex discharge tube was 125 cm in length and 7 cm in diameter. The energy supply was one of 100 kv and the field strength was about 1 kilovolt per cm, compared with 100 volts per cm in the Perhapsatron. The energy for the primary discharge was stored in 38 pieces, each 300 feet long, of RG-19/U cable. The cable was chosen for two reasons: first, it was desirable that the applied voltage should have a very short rise time and remain fairly constant during the period of interest, and second, the cable could be charged to higher voltages than was possible with the condensers then available.\* To reduce stray inductances, the discharge tube and its return conductors were made concentric and were close together (see Fig. 13). The cables were discharged through a spark gap, fired by decompression.

Neutron formation was observed in Columbus I with deuterium, but the number varied widely from one discharge to another. These neutrons probably originated from the collision of electrically accelerated deuterons with other deuterons in the gas or adsorbed on the electrodes, rather than as the result of thermonuclear interaction. Some observations on the pinch effect made at Berkeley had indicated that good (and reproducible) yields of neutrons could be obtained with a quartz tube substituted for one of Pyrex. Consequently, Columbus I' was constructed from a quartz tube, 33 cm long and 3.25 cm in diameter. The primary voltage of 15 kv was obtained from a condenser bank of capacity 33  $\mu$ f, and the discharge current was 150,000 amps. Pulses of neutrons, with an average yield of  $5 \times 10^7$  per pulse, have been obtained, but it is doubtful if they are of thermonuclear origin. It is believed that they arise from deuterons accelerated by the high voltage that would occur in the local constrictions due to the sausage-type instability. This voltage would be the result of the rapidly increasing magnetic inductance in the constrictions.

Two other devices, namely, Columbus I'' (50 kv) and Columbus I<sup>0</sup> (4 kv and very low inductance) have been used for experiments with impulsive, straight pinches of very short duration. Special interest attaches, however, to the larger Columbus II which is under construction. This is designed to operate at 100 kv, and the energy available from condensers of special design is to be  $10^5$  joules, i. e., about 25 times as great as that available for Columbus I'. A short-circuit current of  $2 \times 10^6$  amps is expected, and the initial rate of increase of current should be roughly  $10^{12}$  amps per sec, based on a rise time of about a microsecond.

In order that the maximum energy may be transferred from the source to the load so rapidly, the inductance of the entire system must be very small. Referring to the familiar induction relationship, for constant inductance,

\*In later Columbus models, the cables were discarded in favor of condensers.

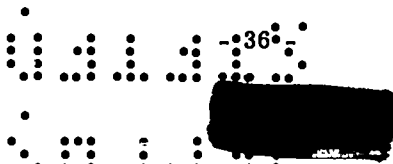

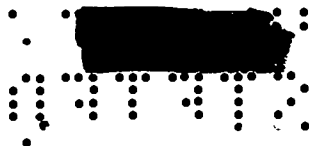

$$V = L \frac{dI}{dt} ,$$

the voltage,  $V$ , is 100 kev, i. e.,  $10^5$  volts, and  $dI/dt$ , the desired rate of current increase, is  $10^{12}$  amps per sec; hence, the inductance,  $L$ , should be about 0.1  $\mu$ h. Such a low inductance calls for unusual specifications for the components and their geometry.

The special (cylindrical) condensers of low inductance, made so that the discharge current runs parallel to the axis of the condenser, will each have a capacity of 0.8  $\mu$ f, a maximum voltage of 100 kv, and an internal inductance of about 0.08  $\mu$ h. Each condenser is 40 inches high and 18 inches in diameter and has a 10-inch long insulator. Twenty-five of these condensers will be connected in parallel, giving a total capacity of 20  $\mu$ f.

The design of Columbus II, and of still larger systems of the same type, has called attention to the danger inherent in the storage of large quantities of electricity in condensers. Safety devices, such as fuses or current-limiting switches, cannot be used because they would introduce inductance into the circuit. A possible solution to this problem is to connect a separate spark gap in series with each condenser and to fire the gaps simultaneously. Any condenser that fails will thus be isolated from the others by its own spark gap. Further, the distribution of the large discharge current between the spark gaps would decrease the tendency for the gaps to blow apart or for the electrodes to be eroded. The difficulty still remains, of course, in achieving simultaneity in firing 25 (or so) spark gaps.

#### Magnetic Induction Machine

Although straight (Columbus) tubes for studying the pinch effect are simple in respect of connecting the power supply, there are disadvantages, notably the introduction of impurities by vaporization of the electrodes during the discharge. Such impurities then act as a source of contamination in subsequent discharges. Further, some of the phenomena occurring at the junction between the electrodes and the discharge are quite obscure and may affect the results obtained.

Consequently, some attention has been given to the design of a system in which an impulsive pinch, comparable to that in a Columbus discharge, will be developed in a toroidal geometry at potential gradients similar to those in Columbus, i. e., 1 to 2 kv per cm. This projected apparatus has been called a Magnetic Induction Machine (or MIM). It will be similar to the Perhapsatron in the respect that the discharge through the gas will be induced in an analogous manner. The toroidal (quartz) tube will have a major radius of about 24 cm and a minor radius of 4.3 cm. It will be surrounded by a primary conductor of copper through which will be passed the discharge from 24 special condensers of the type to be used for Columbus II, i. e., 0.80  $\mu$ f capacity at 100 kv. These will be connected in a series-parallel arrangement

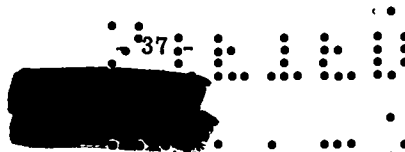

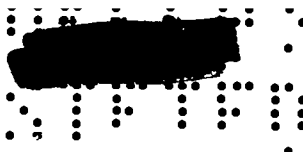

to give 4.8  $\mu\text{f}$  at 200 kv. The total storage capacity will be nearly  $10^5$  joules and the discharge current about  $10^6$  amps, as for Columbus II. The potential gradient expected is 1.3 kv per cm.

Provisional calculations, based on M theory, indicate some uncertainty as to whether external inductance is always detrimental to the pinch compression. The MIM is thus being constructed with the lowest practical inductance, and experiments will be made to determine the general effects of an increase.

#### Stabilization of Pinch by Longitudinal Magnetic Field

One of the most apparently promising methods, at present, for enhancing pinch stability is to superimpose a longitudinal magnetic field on to the discharge. Such a field is readily applied by means of a solenoid wound over the copper primary of the Perhapsatron or the external (return) conductor of the Columbus devices. A theoretical treatment indicated that a longitudinal field would have a stabilizing effect on kink instability, especially in the kinks of short-wave length which, as seen earlier, rapidly lead to a break-up of the pinch.\* From the theory, it was concluded that relatively strong fields would be needed to produce stabilization.

Exploratory observations, made at Los Alamos early in 1954, with longitudinal fields up to 6000 gauss, revealed a difficulty. The strong fields prevented the formation of the pinch, and when the field was reduced to a point where the pinch developed, there was no increase in its duration. More recent experiments have shown, however, that with relatively weak longitudinal magnetic fields, the pinch can definitely be stabilized, although the compression may not be as great as without the field.\*\*

A new theoretical approach, based on the idea that the longitudinal field is trapped and compressed by the pinch, indicates the conditions under which stabilization is to be expected.\*\*\* There is a possibility that long-wave instability may still exist in the presence of the longitudinal field, but this has not yet been established experimentally. If adequate stabilization of the pinch by means of a longitudinal field proves to be practical, an important step will have been taken toward the realization of controlled thermonuclear power. Pinches can then be developed with discharges of moderate potential gradient, and the special condensers of low inductance and very large energy content, such as would be required for an unstable pinch of short duration, will not be necessary.

\* LA-1716

\*\* It is thought that the longitudinal magnetic field stabilizes the sausage-type instability. A complete return conductor around the discharge tube, as in the Columbus devices, would probably stabilize kink instability.

\*\*\* LA-2030



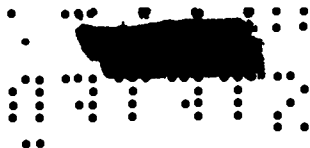

### Picket Fence

Another principle that might be used for enhancing plasma stability is known as "picket fence." The original idea of the picket fence was to use a layer of parallel wires - hence the name - carrying currents in alternating directions. These would generate magnetic fields only in the vicinity of the walls of a discharge tube and thus some economy might be achieved in the power required to confine the plasma. It now appears that, although the picket fence has no advantages over other methods of confinement, a modification does offer prospects in terms of power expenditure for achieving confinement with stability.

Consider the magnetic lines of force confining a plasma to have the general shape shown in Fig. 14. The system is in stable equilibrium only when the shape of the plasma surface is such that the center of curvature of the field lines at the surface lies outside the plasma.

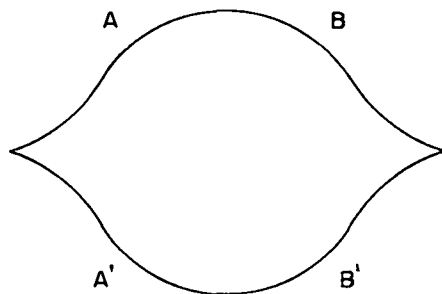
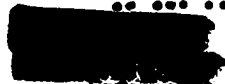

Fig. 14

When the center of curvature is within the plasma, the system is believed to favor flute or sausage-type instability. Consequently, in Fig. 14, the surface is unstable in the regions between A and B and between A' and B', but is stable elsewhere. On the basis of this conclusion, it is apparent that it should be possible, by using coils with currents flowing in opposite directions (as in the picket fence), to shape the plasma so that its cross section has the form of a "bicuspid" (Fig. 15), which is stable everywhere.

A possible drawback to the plasma shaped in this manner is that there may be considerable leakage at the points. The extent of such leakage has not been estimated theoretically because of the uncertainty in treating the behavior of the confined particles. If there is simple reflection at the magnetic walls, the probability of escape will be low. On the other hand, suppose that as the particles gyrate about the magnetic lines of force, the direction of motion is randomized as they pass through the central region of the confined plasma. Upon being transferred to a new line of force, there is a probability that the particle will now follow a



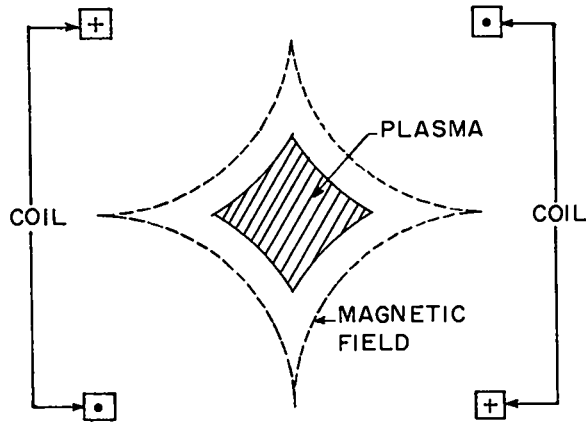
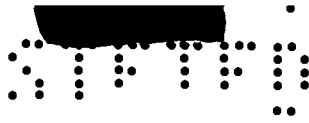

Fig. 15

path which leads to escape. In the latter circumstances, leakage will be high.

A method proposed for reducing leakage is to oscillate the magnetic field very rapidly, by interchanging the directions of the currents at high frequency. This leads to the so-called "moving" picket fence. The use of a radiofrequency field for this purpose would involve a very large power requirement. But the same effect can probably be achieved more economically by superimposing a radiofrequency magnetic field of relatively low power on the DC field (Fig. 16). Thus, the major part of the field would be stationary, but there would be a

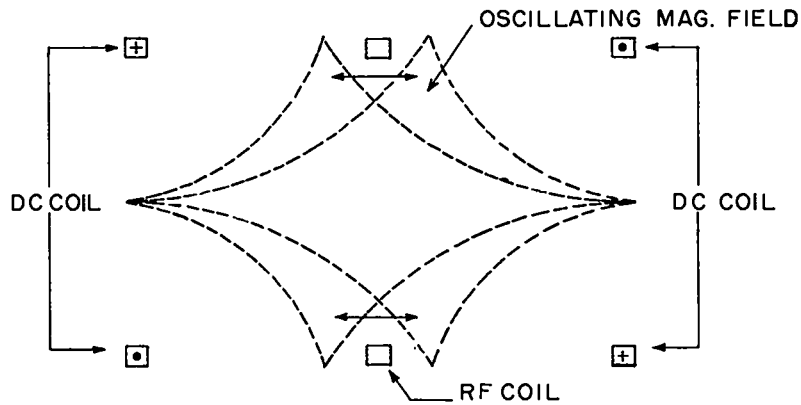
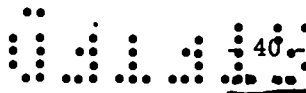

Fig. 16

rapid vibration of the magnetic field at the points of leakage.

Radiofrequency Pinch

A third possibility for producing a fairly stable pinch is to use a discharge induced by means of a high-frequency primary current. If the primary current is decreased before the



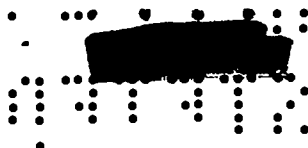

pinch instability has fully developed, the pinch will diffuse to some extent during the low-current half cycle of the alternating field. Then, in the next (high-current) half cycle, it is hoped that the pinch will re-form with the "memory" of the instability, at least partially, removed. The period of the radiofrequency current to achieve this end would have to be shorter than the time of development of the pinch instability. This probably means a frequency of roughly 1 to 10 megacycles per sec. A predictable disadvantage of the radiofrequency pinch is the very high power requirements that appear to be necessary, according to preliminary calculations. It is, however, a line of investigation that is being followed in the event of the failure of what now appear to be more promising developments.

#### Measurement Techniques

A wide variety of techniques have been used for studying the pinch effect in particular and plasma characteristics in general. These include measurements of a conventional type, such as discharge voltage and current, as well as observations on neutron and x-ray (bremsstrahlung) production. Photographic studies, including the use of both still, rotating-mirror (smear), and framing cameras, have supplied useful information on pinch behavior.

In Fig. 17, for example, the top photograph is of an oscillograph pattern showing the time change in the discharge current, and the one below shows the corresponding voltage variations. The intervals indicate microsecond time periods. The corresponding changes in the appearance of the discharge, as seen through a narrow slit, are apparent in the bottom photograph obtained with a rotating-mirror camera. The contraction of the (luminous) plasma to form a pinch of short duration and its subsequent expansion due to instability are evident.

Spectroscopic measurements of several types have been applied to investigate plasma density (Stark broadening), kinetic energy of the particles (Doppler broadening), and the magnetic field (Zeeman splitting). Another application is to study the shock waves formed in a discharge tube. The rotating-mirror photographs in Fig. 18 show (1) the propagation of a shock wave but apparently no true pinch, (2) the formation of the pinch, and (3) the occurrence of both shock waves and pinch. The part played by shock waves can be investigated by time-resolved spectroscopy. A spectral line, e. g.,  $H_{\alpha}$  or  $H_{\beta}$ , is optically magnified and its appearance, as a function of time and of distance from the axis of the (linear) discharge tube, is observed with a number of photomultiplier tubes. Short-time line broadening in the plasma near the walls of the tube early in the discharge would indicate the formation of a shock wave moving away from the tube walls.

Microwave methods have proved of value in studying electron densities, electron-ion recombination rates, electron-neutral collision frequencies, electron-neutral attachment probabilities, and ambipolar diffusion coefficients in a plasma, and their variations in space and



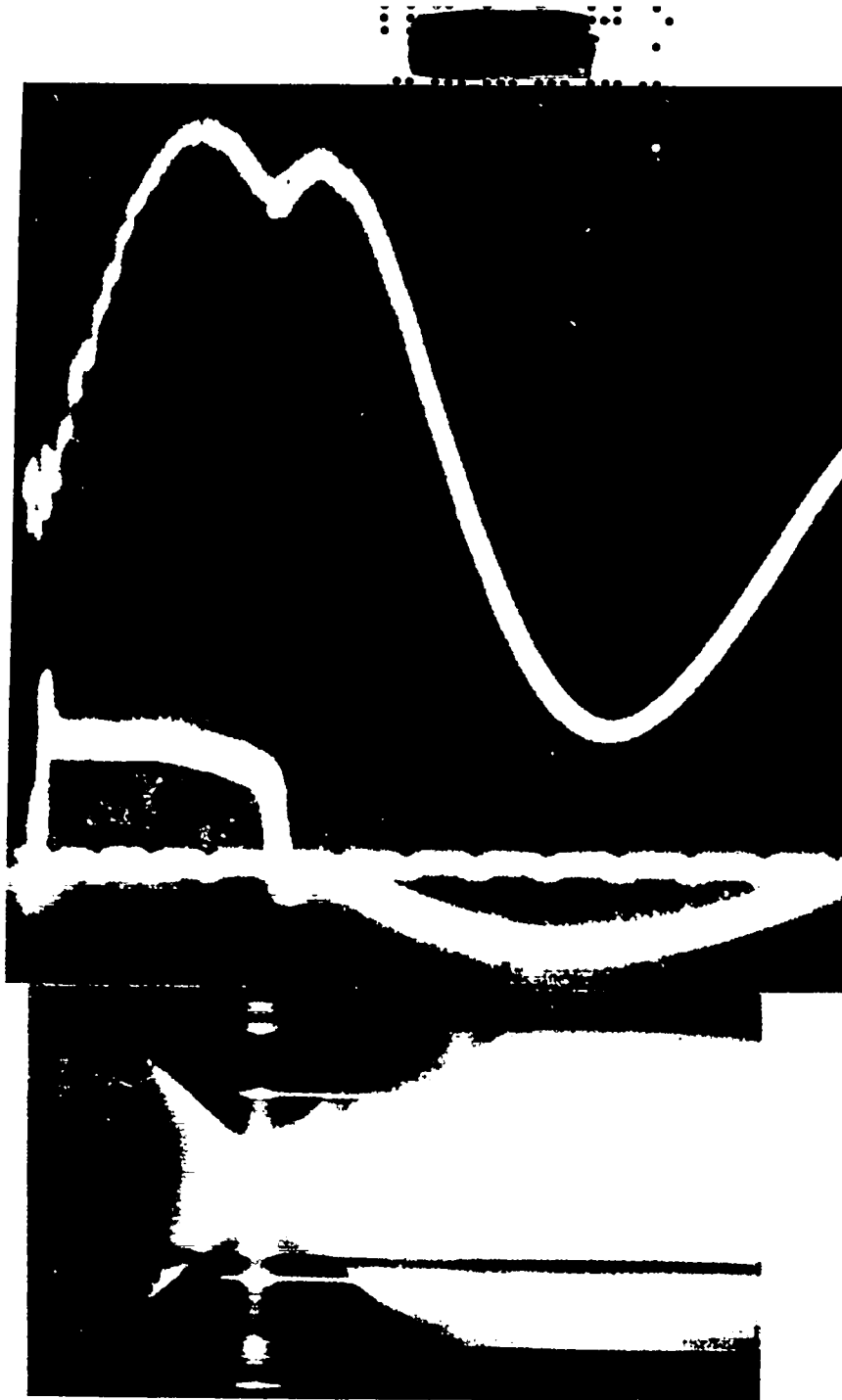

Correlation between current dip, voltage break and light pinch obtained in a 3" diameter 17" long linear discharge using a 5" diameter coaxial return consisting of 3 No. 10 gauge wires. 21 -  $1\mu\text{f}$  condensers each coaxially connected to the tube through a spark gap switch were discharged into the tube at  $1200\mu$  Autovac pressure and 8 KV.  $1\mu\text{sec}$  timing markers are shown on the voltage trace. Peak currents approximately 60000 amperes and  $\text{D}_2$  gas used.

Fig. 17

0111-22  
 0111-22  
 0111-22

43 -



Shocks (a) pinches (b) and combination shocks and pinching (c) observed in (a and b) a 3" diameter 17" long discharge tube with a 5" diameter 8 wire coaxial return, ((c) is with a 4.5" tube in the 5" diameter coaxial return) 10 -  $\mu$ f condensers each coaxially connected to a spark gap switch.  
 (a)  $D_2$  at 1200 $\mu$  Autovac pressure 3 KV      (b)  $D_2$  at 600 $\mu$  Autovac pressure 8 KV  
 (c)  $D_2$  at 400 $\mu$  Autovac pressure 14 KV - 4.5" tube

Fig. 18

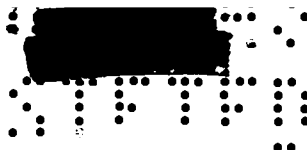

time during a discharge. The basic principle is that the passage of microwaves through a plasma is accompanied by a phase shift of the transmitted wave. This phase shift is dependent upon the dielectric constant of the plasma which can be related to the electron density. The technique used is to compare the phase of the wave passing through the plasma with that traversing the same path length in air or a vacuum. This is the principle of the microwave interferometer shown schematically in Fig. 19. The waves, having a frequency of 60 kilomegacycles (60 KMc) per sec, are applied across the discharge by means of "horns" on the

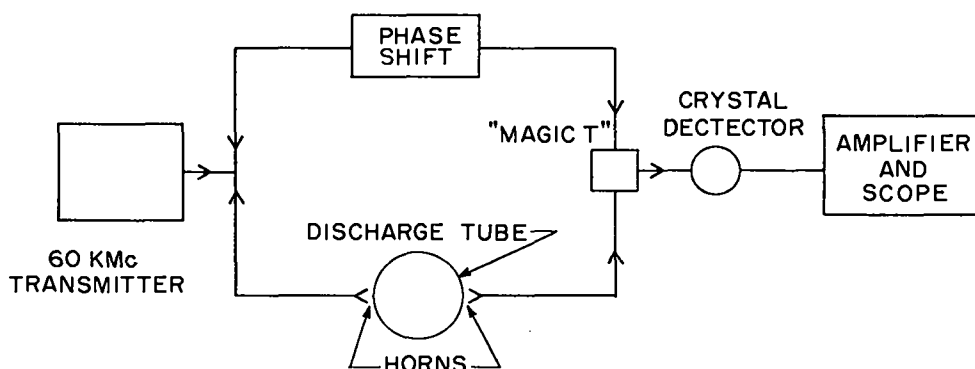

Fig. 19

outside of the tube. The "magic T" prevents the microwaves in one (discharge tube) path entering the other (comparison) path.

A typical (idealized) pattern appearing on the oscilloscope in a pinch discharge is indicated in Fig. 20. The point A represents the beginning of the sensitive region, i. e., a

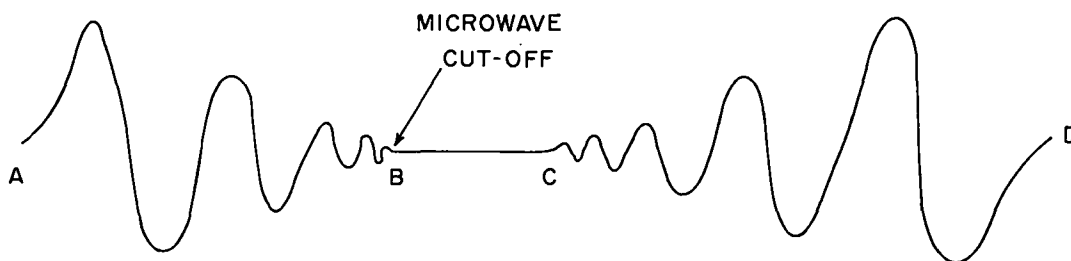
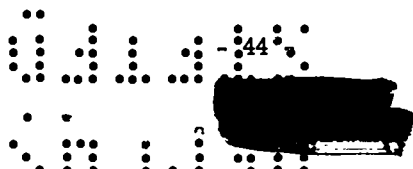
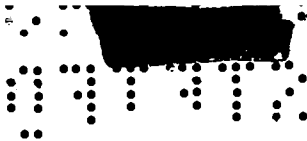

Fig. 20

density of about  $10^{12}$  electrons per  $\text{cm}^3$  for the microwave frequency of 60 KMc being used. From A to B the electron density increases to approximately  $7 \times 10^{13}$  per  $\text{cm}^3$ . At the





cut-off, B, the transmitted microwave frequency is equal to the so-called frequency of the plasma and the microwave energy is all absorbed. From B to C the electron density is too high to probe with the given microwave frequency, but is decreasing. The decrease continues from C, where the density is again detectable, to D, until at D it has fallen to  $10^{12}$  electrons per  $\text{cm}^3$ , which is the limit of the sensitive region.

The electron-neutral collision rate is determined from the attenuation of the oscillations between A and B; the rate of ionization build up is related to the change in frequency of the oscillations; and the recombination, attachment, and diffusion rates can be derived from the oscillations between C and D.

It is thought that the microwave technique can be adapted to provide information concerning the current densities in a pinched discharge, by locating the "horns" in such a manner that the region under observation is away from the tube axis. If the current moves inward when the pinch occurs, the interferometer should show an oscilloscope pattern, starting at B in Fig. 20. The point D would represent the fully pinched condition with no current near the walls of the tube.

The use of microwaves having a frequency of 60 KMc per sec imposes a limit on the maximum electron density which can be detected, namely, about  $7 \times 10^{13}$  per  $\text{cm}^3$ , and also on the position resolution of the microwave beam. These restrictions can be overcome by using waves of higher frequency. Another limitation is that the build up of the ionization in the discharge might be faster than the frequency response the interferometer will handle. This can be avoided by not attempting to measure ionization rates, and determining only electron densities and collision frequencies, from the signal cut-off (point B in Fig. 20), and the decrease in amplitude of the signal envelope (from A to B), respectively.

The electron beam probe is another procedure for studying pinch phenomena. Suppose an electron beam is injected into a pinched system; the beam will be deflected by the strong magnetic field about the pinch. From the deflection, information about the pinched discharge can be obtained. A schematic diagram of the apparatus used is seen in Fig. 21. The electron beam is produced by an electron gun and is accelerated by a pulsed potential of 400 kv. After passage through a slit system, and a positioning bellows which permits adjustment of the beam location, the electron beam enters the discharge tube. It is detected as a luminous spot on a fluorescent (zinc sulfide) screen lining the tube. A superimposed grid permits measurement of the linear and angular displacements of the spot.

A further method of probing the discharge which, it is hoped, will give direct information on pinch behavior, is to use a very small wire coil as a probe. This coil is connected to an oscilloscope, where the voltage developed across the probe, by the changing magnetic inductance,

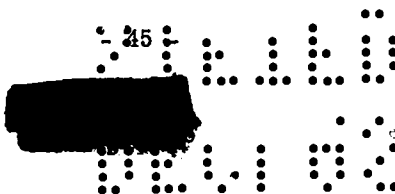

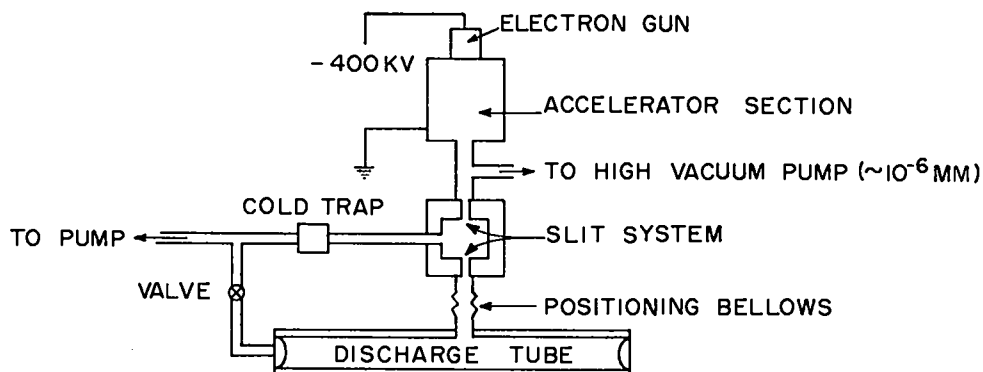
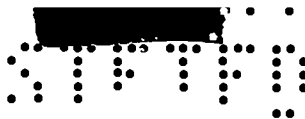

Fig. 21

is indicated. One of the problems in pinch studies is to determine the radius of the discharge. Photographic studies may be misleading, since it is becoming apparent that the luminous pinch does not necessarily always coincide with the current pinch. A simple, material probe, of the type just described, may prove useful in solving this problem.

Apart from the observations on the discharge itself, it is necessary to study the products of the discharge, such as neutrons and protons from the two DD reactions. In this connection use is being made of nuclear plate techniques, which have reached a high state of development in the Laboratory for a variety of neutron and charged-particle measurements. Neutrons originating in the discharge fall on a nuclear plate and tracks are produced by the recoil protons. From these tracks it is possible to determine the neutron yield and energy, and also to deduce the velocity and direction of the deuterons taking part in the DD reaction.

A further use for nuclear plates is to determine the size (or area) of the region in the discharge tube from which protons originate. In the case of a straight tube (Columbus type) discharge, there are slits at the ends of the tube with windows which permit passage of the protons. These protons are then incident upon nuclear plates, forming tracks which can be analyzed. In addition to providing information concerning the region of origin of the protons, as intended, the data can be used to determine the proton yield and energy.

#### General References

Much of the basic information concerning controlled thermonuclear studies is to be found in the reports of the papers presented at a number of conferences on the subject held in recent years. They are as follows:

WASH-115	- Denver, June 1952	WASH-184	- Princeton, October 1954
WASH-146	- Berkeley, April 1953	WASH-289	- Livermore, February 1955
TID-7503	- Princeton, October 1955		





  
UNCLASSIFIED

UNCLASSIFIED