

**LA-8365-MS**

Informal Report

C. 3

CIC-14 REPORT COLLECTION

**REPRODUCTION  
COPY**

**PEFPYD - A Library of Aggregate Fission-Product  
Decay Data Derived from ENDF/B-IV**

University of California



**LOS ALAMOS SCIENTIFIC LABORATORY**

Post Office Box 1663 Los Alamos, New Mexico 87545

This report was not edited by the Technical Information staff.

This work was supported by the US Department of Energy, Division of Reactor Research and Technology.

This report was prepared as an account of work sponsored by the United States Government. Neither the United States nor the United States Department of Energy, nor any of their employees, makes any warranty, express or implied, or assumes any legal liability or responsibility for the accuracy, completeness, or usefulness of any information, apparatus, product, or process disclosed, or represents that its use would not infringe privately owned rights. Reference herein to any specific commercial product, process, or service by trade name, mark, manufacturer, or otherwise, does not necessarily constitute or imply its endorsement, recommendation, or favoring by the United States Government or any agency thereof. The views and opinions of authors expressed herein do not necessarily state or reflect those of the United States Government or any agency thereof.

LA-8365-MS  
Informal Report  
UC-34c  
Issued: May 1980

# PEFPYD - A Library of Aggregate Fission-Product Decay Data Derived from ENDF/B-IV

R. J. LaBauve  
D. C. George

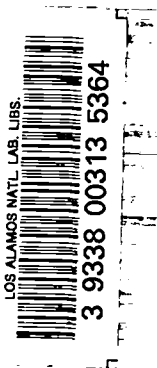

PEFPYD - A LIBRARY OF AGGREGATE FISSION-PRODUCT  
DECAY DATA DERIVED FROM ENDF/B-IV

by

R. J. LaBauve and D. C. George

ABSTRACT

Results from summation calculations by the CINDER-10 and peripheral codes and fission-product decay, cross section and yield data from the ENDF/B-IV have been incorporated into a processed ENDF/B fission-product and energy-yield data (PEFPYD) library. The organization and content of this basic fine-group source-term library is described. The library contains aggregate beta and gamma spectra produced by neutrons of one or more energies incident upon six important nuclides. Although the PEFYD library is described in other Los Alamos Scientific Laboratory reports, it is the purpose here to provide concise documentation for the library alone.

---

I. INTRODUCTION

The ENDF/B-IV fission-product files contain neutron cross sections, decay constants, decay energies, and other decay data for 824 important fission products. They also contain fission yields for these fission products produced by one or more fission-neutron energies (14 MeV, fast, and thermal fission) of six important nuclides:  $^{232}\text{Th}$ ,  $^{233}\text{U}$ ,  $^{235}\text{U}$ ,  $^{238}\text{U}$ ,  $^{239}\text{Pu}$ , and  $^{241}\text{Pu}$ . Also, spectral data (i.e., beta end-point energies and intensities, gamma-line energies and intensities) exist for the most important decay-heat contributors among the 824 nuclides. In ENDF/B-IV, beta-spectral data exist for 163 fission products, and gamma-spectral data exist for 172 nuclides (nuclides emitting both beta and gamma radiation are included separately in both types of radiation counts). The contents of the ENDF/B-IV fission-product file are detailed in Refs. 1-3 and summarized in Table I.

In recent years, great emphasis has been placed on obtaining experimental and computational information on delayed energy release at short cooling times for nuclear reactor safety studies of the hypothetical loss-of-coolant-accident (LOCA). There is, however, also interest in long cooling times. A computer code system<sup>4,5</sup> has been developed at the Los Alamos Scientific Laboratory (LASL) that uses the ENDF/B-IV fission-product data to calculate cumulative delayed beta and gamma spectra on arbitrary energy grids for arbitrary irradiation histories and cooling times. This code system is shown in Fig. 1.

It can be noted in the figure that the basic ENDF/B-IV fission-product data library is accessed along three paths. The center path, after the preparation of an input library, proceeds via the CINDER-10 code. CINDER-10 is the latest and most versatile version of CINDER, a well-known fission-product and depletion code. The most recent documentation on CINDER is Ref. 4 (for Version 7), but the additional features of Version 10 are discussed in Ref. 6. CINDER-10 calculates fission-product and actinide concentrations, activities, gaseous contents, energy releases, effective group absorption cross sections, etc. for any fissionable nuclide mixture irradiated in arbitrary neutron fluxes for arbitrary intervals of time followed by arbitrary cooling times. The neutron cross sections<sup>7,8</sup> used in CINDER-10 are generated by spectrum collapse of multigroup data generated with the NJOY code.<sup>9</sup> This input path to CINDER-10 is the lower path shown in the figure. Spectrum collapse is achieved with the TOAFEW<sup>8</sup> code.

The ENDF/B-IV data is also accessed by the FPDCYS code along the upper processing path shown in Fig. 1. This code is used to generate multigroup beta and gamma spectra for individual nuclides for which spectral data exist on the ENDF/B-IV file. FPDCYS incorporates four options for calculating beta spectra and two options for calculating gamma spectra. The differences among the four beta-spectrum options are mainly in the ways in which the Fermi function  $F(Z,W)$  is represented and calculated. The first of the two gamma-spectrum options consists of incorporating the unbroadened lines weighted by their intensities into an arbitrary number of energy groups. Alternatively, gamma lines are broadened according to detector resolutions before multigrouping in the second option.

The output of FPDCYS and the output of CINDER-10 are input to the FPSPEC code. Actually, only a small portion of the CINDER-10 output is utilized, namely, fission-product activities and total decay energies at the instant of time when corresponding spectra are sought. FPSPEC combines the individual

TABLE I

SUMMARY OF ENDF/B-IV FISSION-PRODUCT DATA FILE CONTENT

- 824 Nuclides (total)
- 181 Have differential cross sections
- 180 Have individual  $\beta$  and  $\gamma$  "lines" (spectral data consisting of energies and intensities)
- 712 Are unstable and each has an average  $\beta$ ,  $\gamma$ , and  $\alpha$  energy and branching fraction
- 10 Yield sets for 6 fissionable nuclides ( $\sim 10\ 000$  yields)

( $\sim 310\ 000$  Data entries required in ENDF/B-IV)

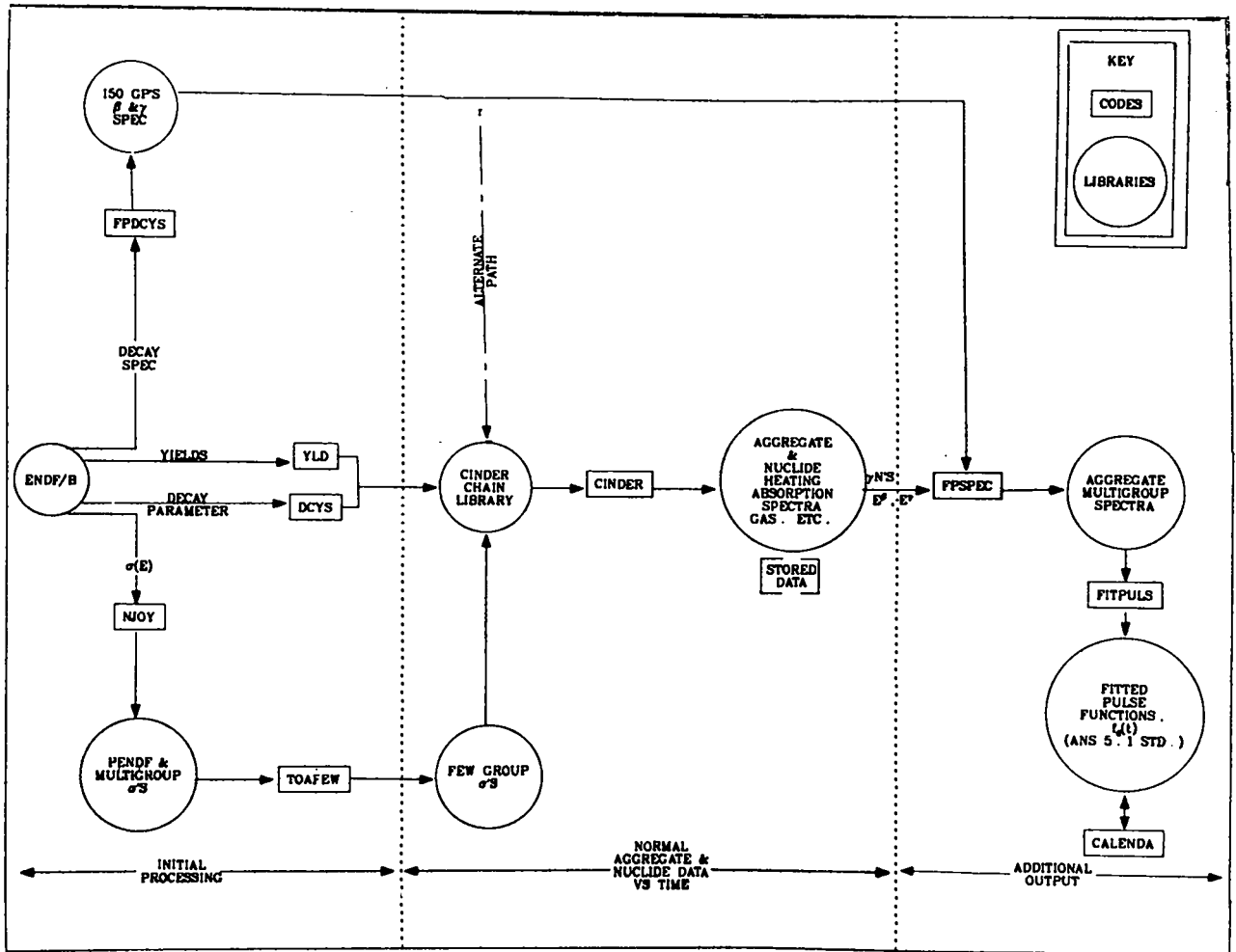

Fig. 1.  
LASL nuclide processing codes and libraries.

spectra from FPDCYS and the nuclide activities from CINDER-10 to generate aggregate fission-product spectra for each irradiation and shutdown time. Note that CINDER-10 also incorporates a spectral subroutine capable of utilizing the multigroup data produced by the FPDCYS code. Plots of sample output from FPSPEC are shown in Figs. 2-5. In these illustrations, the calculated spectra are compared with the LASL experiment cited in Ref. 10.

As indicated above, spectral data are not available for all 824 fission products in ENDF/B-IV, and missing spectra must be approximately constructed. This is done for a particular nuclide by assuming that the shape of the beta (or gamma) spectrum for the nuclide is approximated by the spectrum shape of the aggregate 181 nuclides from a pulse after a cooling time approximately equal to the half-life of the nuclide in question. This shape is then normalized to the average beta- (gamma-) decay energy of the nuclide. Figures 6 and 7, respectively, compare the gamma spectra of  $^{139}\text{Cs}$  with those constructed for a hypothetical nuclide having the same half-life and average gamma- and beta-decay energies as  $^{139}\text{Cs}$ . The nuclide  $^{139}\text{Cs}$  is a relatively important nuclide in the 0.1-s cooling time bin for 20 000-h thermal irradiation of  $^{235}\text{U}$ . *However, it should be noted that such constructed individual spectra are used only in the aggregate.*

The libraries used in the CINDER-10 and auxiliary codes FPDCYS and FPSPEC are extensive and the codes are designed to use the libraries for any specified irradiation history. However, for many users the scope of application is unnecessary and aggregate results, rather than the detailed nuclide-by-nuclide output, are needed. The purpose of this report and the codes described in Ref. 11 is to eliminate the need for extensive summation code calculations for a wide range of problems. The summation codes and libraries have been used to produce multigroup beta and gamma spectra vs time following fission pulses, including the components of the spectra due to halogens and noble gases for a wide range of applications.

We have used the summation codes and libraries to produce secondary aggregate libraries and pulse functions shown as "additional output" in Fig. 1, which can be used directly or incorporated into neutronics codes. In particular, we have

- Used the summation codes to produce beta- and gamma-temporal spectra in 150 groups following fission pulses for each fuel and fission neutron energy in ENDF/B-IV and stored the results in formats similar to ENDF/B. These files delineate the noble gas and halogen spectra. Users can readily collapse the results to other multigroup spectra.

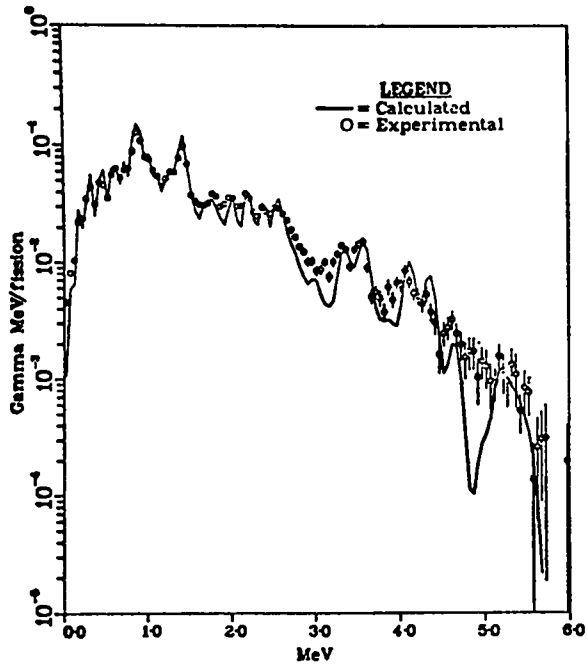

Fig. 2.

Gamma spectrum 5.56-h irradiation of  $^{235}\text{U}$ , 70-s cooling.

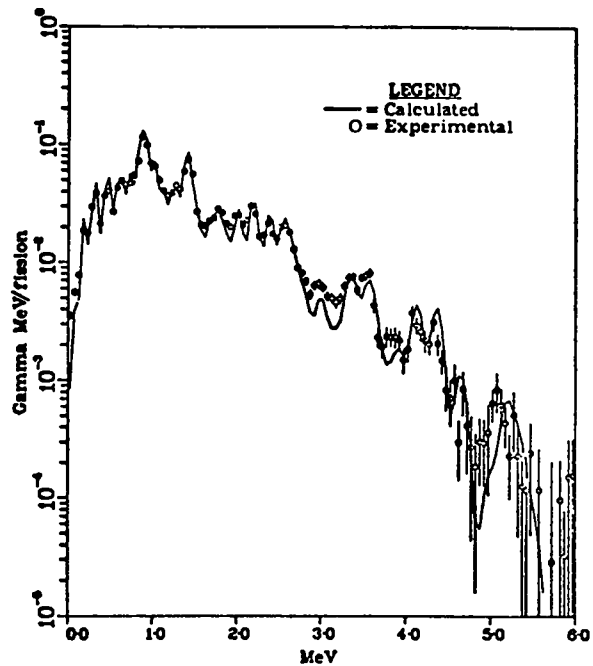

Fig. 3.

Gamma spectrum, 5.56-h irradiation of  $^{235}\text{U}$ , 199-s cooling.

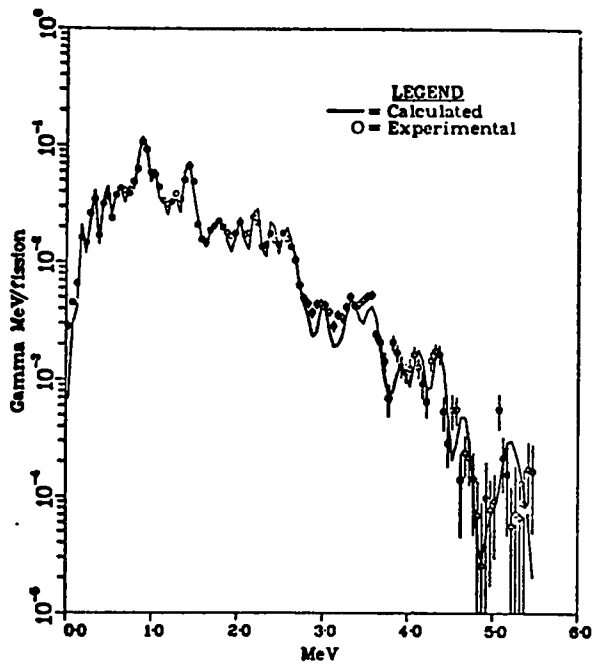

Fig. 4.

Gamma spectrum, 5.56-h irradiation of  $^{235}\text{U}$ , 388-s cooling.

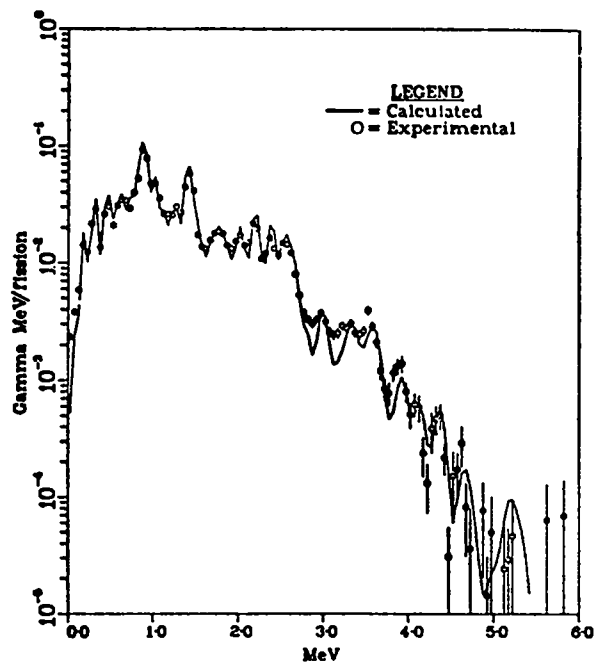

Fig. 5

Gamma spectrum, 5.56-h irradiation of  $^{235}\text{U}$ , 660-s cooling.



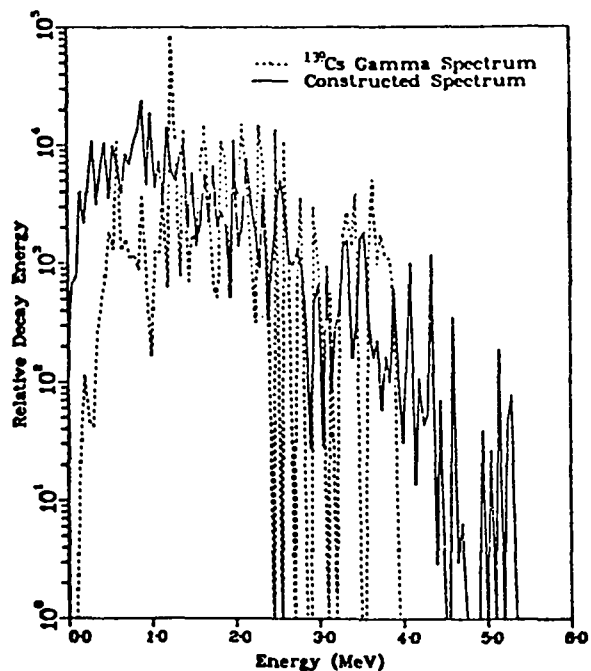

Fig. 6.  
 $^{139}\text{Cs}$  gamma spectrum compared with constructed spectrum.

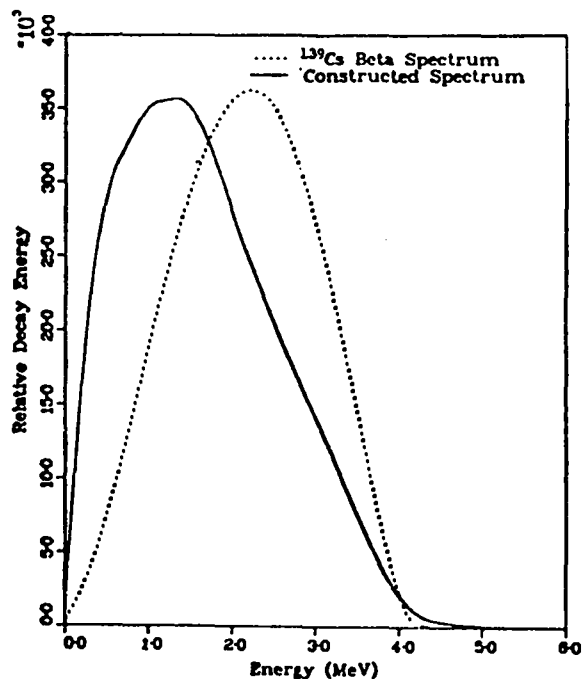

Fig. 7.  
 $^{139}\text{Cs}$  beta spectrum compared with constructed spectrum.

- Collapsing and exponential fitting and folding codes have been developed, the latter being useful for generation of spectra following finite power histories.<sup>11,12</sup>
- For immediate use, exponential fits to a particular few-group spectra have been made available.<sup>11,12</sup>

Because the spectra are based on fission pulses, the libraries have a general utility. The exponential fits, for example, can be folded into any power (fission) history that can be described analytically or by a histogram representation. The effects of neutron absorption are also treated and approximately accounted for in the methodology.<sup>11</sup>

## II. LIBRARY FOR PROCESSED ENDF/B AGGREGATE FISSION PRODUCT SPECTRA

Of particular interest is the application of the LASL code system to produce delayed beta- and gamma-spectral data on a fine energy grid (150 groups in 0.05 MeV steps from 0 to 7.5 MeV) for irradiation of the ENDF/B-IV fissionable nuclides with very short pulses (typically  $10^{-4}$ -s irradiation time; shorter pulses do not alter the calculated spectra) of thermal, fast, and 14-MeV neutrons. The results can then be further processed into broad groups and fit with

functions of the type  $f_c(t) = \sum_{i=1}^n \alpha_i e^{-\lambda_i t}$ , as described in Refs. 11 and 12.

The fine-group results from the LASL code system are assembled into a single library in an ENDF-like format.<sup>13</sup> Definitions for the format for this processed ENDF/B fission-product and energy-yield data (PEFPYD) library are as follows.

MAT: Mat-No. of target nucleus, same as in ENDF/B.

MF: File No., used to identify energy type of incident neutron, defined as follows:

MF=80 - fission induced by thermal neutrons

MF=81 - fission induced by fast neutrons

MF=82 - fission induced by high-energy (14-MeV) neutrons.

Fission nuclide and energy combinations available in ENDF/B-IV are given in Table II.

MT: Section number used to describe data contents of the section. MT numbers are as follows:

MT=801 - delayed energy/fission for  $\beta^- + \gamma$  summed over all fission products

MT=802 - delayed energy/fission for  $\beta^-$  summed over all fission products

MT=803 - delayed energy/fission for  $\gamma$  summed over all fission products

MT=811 - delayed energy/fission for  $\beta^- + \gamma$  summed over all gaseous fission products (halogens plus noble gases)

MT=812 - delayed energy/fission for  $\beta^-$  summed over all gaseous fission products

MT=813 - delayed energy/fission for  $\gamma$  summed over all gaseous fission products

MT=821 - delayed energy/fission for  $\gamma + \beta^-$  summed over the noble gas fission products

MT=822 - delayed energy/fission for  $\beta^-$  summed over noble gas fission products

MT=823 - delayed energy/fission for  $\gamma$  summed over noble gas fission products

MT=831 - delayed energy/fission for  $\beta^- + \gamma$  summed over halogen fission products

MT=832 - delayed energy/fission for  $\beta^-$  summed over halogen fission products

MT=833 - delayed energy/fission for  $\gamma$  summed over halogen fission products

Other MT-numbers can be defined as needed; for example, MT-numbers could be assigned to any of the above spectra summed over energy.

TABLE II  
FISSION YIELD DATA IN ENDF/B-IV

<u>Nuclide</u>	<u>Incident Neutron Energy Type</u>		
	<u>Thermal</u>	<u>Fast</u>	<u>High Energy (14 MeV)</u>
$^{232}\text{Th}$	--	Yes	No
$^{233}\text{U}$	Yes	No	No
$^{235}\text{U}$	Yes	Yes	Yes
$^{238}\text{U}$	--	Yes	Yes
$^{239}\text{Pu}$	Yes	Yes	No
$^{241}\text{Pu}$	Yes	No	No

The data are given in a TAB2 record with tables of spectra (decay energy/fission vs energy) given for a number of cooling times. Standard ENDF/B interpolation schemes between cooling times (TAB2 interpolation) are not recommended and, in any case, would be of interest only for fission pulses. However, when the pulse data are placed on a broad-group mesh and fitted with parameters as described in Refs. 11 and 12, calculations for any irradiation-cooling time combinations are possible, precluding the need for interpolation on the fine grid. Histogram interpolation is assigned for TAB1 interpolations.

File 1 (MF=1) information is also included, giving some processing information and a "dictionary" of the data to follow. The structure of MF=1 is as described in ENDF-102.<sup>13</sup> The structure of a section containing the processed data is

```
[MAT,MF,MT/ZA,AWR,0,0,0,0] HEAD
[MAT,MF,MT/0.0,0.0,0,0,1,NTS/TSint] TAB2
[MAT,MF,MT/0.0,TS1,0,0,1,NP/E'int/DE(E',TS1)] TAB1
[MAT,MF,MT/0.0,TS2,0,0,1,NP/E'int/DE(E',TS2)] TAB1
-----
-----
[MAT,MF,MT/0.0,TDNFS,0,0,1,NP/E'int/DE(E',TSNTS)] TAB1
[MAT,MF,MT/0.0,0.0,0,0,0,0] SEND
```

where

TS = cooling time step in seconds

DE = decay energy in MeV/fission (MeV/s)/(fiss/s)

E' = energy of particle ( $\beta^-$ ) [photon ( $\gamma$ )] in MeV

NTS = number of cooling time steps given for a particular MT

NP = number of DE,E' pairs given in a particular TAB1 record.

Other quantities are defined in ENDF-102. Note that interpolation along cooling-time steps (the TAB2 records) is always set to zero, meaning that interpolation is not recommended, and that interpolation is always set to one (histogram) for the TAB1 records. A sample PEFPYD listing is given in Appendix A.

#### REFERENCES

1. Fission-Product Decay Library of the Evaluated Data File, Version IV (ENDF/B-IV). [Available from and maintained by the National Nuclear Data Center (NNDC) at the Brookhaven National Laboratory; these data were compiled by a two-year task force chaired by R. E. Schenter..]
2. T. R. England and R. E. Schenter, "ENDF/B-IV Fission-Product Files: Summary of Major Nuclide Data," Los Alamos Scientific Laboratory report LA-6116-MS (ENDF-223) (October 1975).
3. C. W. Reich, R. G. Helmer, and M. H. Putnam, "Radioactive-Nuclide Decay Data for ENDF/B," Aerojet Nuclear Company report ANCR=1157 (ENDF-120) (August 1974).
4. T. R. England, R. Wilczynski, and N. L. Whittemore, "CINDER-7: An Interim Report for Users," Los Alamos Scientific Laboratory report LA-5885-MS (April 1975).
5. M. G. Stamatelatos and T. R. England, "FPDCYS and FPSPEC, Computer Programs for Calculating Fission-Product Beta and Gamma Multigroup Spectra from ENDF/B IV Data," Los Alamos Scientific Laboratory report LA-NUREG-6818-MS (May 1977).
6. T. R. England, M. G. Stamatelatos, and N. L. Whittemore in "Applied Nuclear Data Research and Development," Los Alamos Scientific Laboratory report LA-6472-PR (1976) p. 60, and "Applied Nuclear Data Research and Development," Los Alamos Scientific Laboratory report LA-6266-PR (1976), p. 13.
7. W. B. Wilson, T. R. England, M. G. Stamatelatos, and R. J. LaBauve, "ENDF/B-IV Fission Product Cross Sections: Absorption Buildup in Thermal Reactors," Trans. Am. Nucl. Soc. 26, 592 (June 1977).
8. W. B. Wilson, T. R. England, and R. J. LaBauve, "Multigroup and Few-Group Cross Sections for ENDF/B-IV Fission Products; The TOAFEW Collapsing Code and Data File of 154-Group Fission-Product Cross Sections," Los Alamos Scientific Laboratory report LA-7174-MS (March 1978).

9. R. E. MacFarlane and R. M. Boicourt, "NJOY: A Neutron and Photon Cross Section Processing System," Trans. Am. Nucl. Soc. 22, 720 (November 1975).
10. E. T. Journey, P. J. Bendt, and T. R. England, "Fission Product Gamma Spectra," Los Alamos Scientific Laboratory report LA-7620-MS (1979).
11. R. J. LaBauve, T. R. England, D. C. George, and M. G. Stamatelatos, "The Application of a Library of Processed ENDF/B-IV Fission-Product Aggregate Decay Data in the Calculation of Decay-Energy Spectra," Los Alamos Scientific Laboratory report LA-7483-MS (1978).
12. R. J. LaBauve, D. C. George, and T. R. England, "FITPULS, A Code for Obtaining Analytic Fits to Aggregate Fission Product Decay-Energy Spectra," Los Alamos Scientific Laboratory report LA-8277-MS (1980).
13. D. Garber, C. Dunford, and S. Pearlstein, Eds., "ENDF-102 Data Formats and Procedures for the Evaluated Nuclear Data File, ENDF," Brookhaven National Laboratory report BNL-NCS-50496 (ENDF-102) (General Reactor Technology TID-4500) (October 1975).



6.15000+	0	5.65372-	8	6.20000+	0	5.74158-	8	6.25000+	0	5.13914-	8126080801	71
6.30000+	0	4.88171-	8	6.35000+	0	4.62415-	8	6.40000+	0	4.36638-	8126080801	72
6.45000+	0	4.11090-	8	6.50000+	0	3.85459-	8	6.55000+	0	3.60262-	8126080801	73
6.60000+	0	3.35521-	8	6.65000+	0	3.11016-	8	6.70000+	0	2.86899-	8126080801	74
6.75000+	0	2.63316-	8	6.80000+	0	2.40447-	8	6.85000+	0	2.18150-	8126080801	75
6.90000+	0	1.96579-	8	6.95000+	0	1.75811-	8	7.00000+	0	1.55985-	8126080801	76
7.05000+	0	1.37119-	8	7.10000+	0	1.19289-	8	7.15000+	0	1.02689-	8126080801	77
7.20000+	0	8.73188-	9	7.25000+	0	7.32971-	9	7.30000+	0	6.07581-	9126080801	78
7.35000+	0	4.97810-	9	7.40000+	0	4.04345-	9	7.45000+	0	3.28865-	9126080801	79
7.50000+	0	0.00000+	0	0.00000+	0	0.00000+	0	0.00000+	0	0.00000+	0126080801	80
0.		1.0000E-01	0	0	0	0	0	0	1	151126080801	81	
	151	1	0	0	0	0	0	0	0	0126080801	82	
0.00000+	0	3.26427-	9	5.00000-	2	3.00945-	8	1.00000-	1	1.35166-	6126080801	83
1.50000-	1	1.17927-	7	2.00000-	1	1.83238-	7	2.50000-	1	4.80269-	7126080801	84
3.00000-	1	1.31992-	7	3.50000-	1	4.71329-	7	4.00000-	1	4.03604-	7126080801	85
4.50000-	1	1.56042-	6	5.00000-	1	2.77795-	6	5.50000-	1	1.96015-	6126080801	86
6.00000-	1	9.32578-	7	6.50000-	1	2.68349-	7	7.00000-	1	4.57189-	7126080801	87
7.50000-	1	3.66561-	7	8.00000-	1	7.44415-	6	8.50000-	1	3.44860-	7126080801	88
9.00000-	1	4.22588-	7	9.50000-	1	6.51400-	7	1.00000+	0	3.97354-	7126080801	89
1.05000+	0	5.30506-	7	1.10000+	0	1.06085-	6	1.15000+	0	3.87395-	7126080801	90
1.20000+	0	1.26719-	6	1.25000+	0	8.84027-	7	1.30000+	0	9.51841-	7126080801	91
1.35000+	0	5.58925-	7	1.40000+	0	1.25644-	6	1.45000+	0	6.77143-	7126080801	92
1.50000+	0	7.59974-	7	1.55000+	0	6.81808-	7	1.60000+	0	5.94550-	7126080801	93
1.65000+	0	6.06114-	7	1.70000+	0	6.36427-	7	1.75000+	0	7.31142-	7126080801	94
1.80000+	0	6.10315-	7	1.85000+	0	6.86816-	7	1.90000+	0	6.33232-	7126080801	95
1.95000+	0	7.40153-	7	2.00000+	0	6.87971-	7	2.05000+	0	6.51582-	7126080801	96
2.10000+	0	7.08404-	7	2.15000+	0	6.54507-	7	2.20000+	0	6.91587-	7126080801	97
2.25000+	0	7.14390-	7	2.30000+	0	7.30416-	7	2.35000+	0	6.73448-	7126080801	98
2.40000+	0	7.25535-	7	2.45000+	0	9.02309-	7	2.50000+	0	7.23584-	7126080801	99
2.55000+	0	8.89761-	7	2.60000+	0	7.17790-	7	2.65000+	0	6.49278-	7126080801	100
2.70000+	0	8.65183-	7	2.75000+	0	7.29565-	7	2.80000+	0	7.05783-	7126080801	101
2.85000+	0	7.10765-	7	2.90000+	0	6.54981-	7	2.95000+	0	5.86755-	7126080801	102
3.00000+	0	5.81519-	7	3.05000+	0	5.75780-	7	3.10000+	0	5.81924-	7126080801	103
3.15000+	0	5.46665-	7	3.20000+	0	5.19562-	7	3.25000+	0	5.02102-	7126080801	104
3.30000+	0	5.01930-	7	3.35000+	0	5.08229-	7	3.40000+	0	4.90639-	7126080801	105
3.45000+	0	4.45334-	7	3.50000+	0	4.53535-	7	3.55000+	0	6.06356-	7126080801	106
3.60000+	0	4.45248-	7	3.65000+	0	3.88778-	7	3.70000+	0	3.85434-	7126080801	107
3.75000+	0	3.66869-	7	3.80000+	0	3.72868-	7	3.85000+	0	3.19040-	7126080801	108
3.90000+	0	3.12778-	7	3.95000+	0	2.94852-	7	4.00000+	0	2.78479-	7126080801	109
4.05000+	0	3.57605-	7	4.10000+	0	3.41349-	7	4.15000+	0	2.39684-	7126080801	110
4.20000+	0	2.34814-	7	4.25000+	0	2.65876-	7	4.30000+	0	2.05854-	7126080801	111
4.35000+	0	2.24058-	7	4.40000+	0	2.08020-	7	4.45000+	0	1.85383-	7126080801	112
4.50000+	0	1.79894-	7	4.55000+	0	1.58358-	7	4.60000+	0	2.01107-	7126080801	113
4.65000+	0	1.44771-	7	4.70000+	0	1.39300-	7	4.75000+	0	1.35261-	7126080801	114
4.80000+	0	1.72003-	7	4.85000+	0	1.27919-	7	4.90000+	0	1.46056-	7126080801	115
4.95000+	0	1.22569-	7	5.00000+	0	1.17626-	7	5.05000+	0	1.32343-	7126080801	116
5.10000+	0	1.10689-	7	5.15000+	0	1.63524-	7	5.20000+	0	1.49543-	7126080801	117
5.25000+	0	1.01508-	7	5.30000+	0	1.16525-	7	5.35000+	0	1.06498-	7126080801	118
5.40000+	0	1.02971-	7	5.45000+	0	1.05369-	7	5.50000+	0	9.30944-	8126080801	119
5.55000+	0	1.36378-	7	5.60000+	0	1.22646-	7	5.65000+	0	7.49731-	8126080801	120
5.70000+	0	8.80978-	8	5.75000+	0	6.93523-	8	5.80000+	0	6.66790-	8126080801	121
5.85000+	0	8.04596-	8	5.90000+	0	8.35016-	8	5.95000+	0	5.92657-	8126080801	122
6.00000+	0	9.04858-	8	6.05000+	0	5.47146-	8	6.10000+	0	7.27049-	8126080801	123
6.15000+	0	5.01629-	8	6.20000+	0	5.11212-	8	6.25000+	0	4.55597-	8126080801	124
6.30000+	0	4.32583-	8	6.35000+	0	4.09564-	8	6.40000+	0	3.86528-	8126080801	125
6.45000+	0	3.63701-	8	6.50000+	0	3.40807-	8	6.55000+	0	3.18309-	8126080801	126
6.60000+	0	2.96220-	8	6.65000+	0	2.74348-	8	6.70000+	0	2.52832-	8126080801	127
6.75000+	0	2.31802-	8	6.80000+	0	2.11409-	8	6.85000+	0	1.91540-	8126080801	128
6.90000+	0	1.72328-	8	6.95000+	0	1.53840-	8	7.00000+	0	1.36197-	8126080801	129
7.05000+	0	1.19424-	8	7.10000+	0	1.03587-	8	7.15000+	0	8.88554-	9126080801	130
7.20000+	0	7.52338-	9	7.25000+	0	6.28258-	9	7.30000+	0	5.17496-	9126080801	131
7.35000+	0	4.20781-	9	7.40000+	0	3.38746-	9	7.45000+	0	2.72853-	9126080801	132
7.50000+	0	0.00000+	0	0.00000+	0	0.00000+	0	0.00000+	0	0.00000+	0126080801	133
0.		5.0000E-01	0	0	0	0	0	0	1	151126080801	134	
	151	1	0	0	0	0	0	0	0	0126080801	135	
0.00000+	0	2.63077-	9	5.00000-	2	2.47622-	8	1.00000-	1	7.81174-	7126080801	136
1.50000-	1	9.11359-	8	2.00000-	1	1.42424-	7	2.50000-	1	3.71510-	7126080801	137
3.00000-	1	9.83881-	8	3.50000-	1	3.62260-	7	4.00000-	1	2.78953-	7126080801	138
4.50000-	1	1.02792-	6	5.00000-	1	1.93354-	6	5.50000-	1	1.29272-	6126080801	139
6.00000-	1	7.12655-	7	6.50000-	1	2.05551-	7	7.00000-	1	3.49458-	7126080801	140
7.50000-	1	2.79559-	7	8.00000-	1	4.18924-	6	8.50000-	1	2.53794-	7126080801	141
9.00000-	1	3.23443-	7	9.50000-	1	4.92805-	7	1.00000+	0	2.89703-	7126080801	142
1.05000+	0	3.98011-	7	1.10000+	0	8.02091-	7	1.15000+	0	2.86120-	7126080801	143
1.20000+	0	8.08981-	7	1.25000+	0	6.51911-	7	1.30000+	0	7.26538-	7126080801	144
1.35000+	0	4.03648-	7	1.40000+	0	9.75694-	7	1.45000+	0	5.04917-	7126080801	145

1.50000+	0	5.66813-	7	1.55000+	0	5.02920-	7	1.60000+	0	4.35995-	7126080801	146
1.65000+	0	4.40911-	7	1.70000+	0	4.60458-	7	1.75000+	0	5.34549-	7126080801	147
1.80000+	0	4.39172-	7	1.85000+	0	4.93761-	7	1.90000+	0	4.54248-	7126080801	148
1.95000+	0	5.38394-	7	2.00000+	0	4.92727-	7	2.05000+	0	4.61637-	7126080801	149
2.10000+	0	5.07979-	7	2.15000+	0	4.63842-	7	2.20000+	0	4.92530-	7126080801	150
2.25000+	0	5.10027-	7	2.30000+	0	5.23134-	7	2.35000+	0	4.74446-	7126080801	151
2.40000+	0	5.13710-	7	2.45000+	0	6.32814-	7	2.50000+	0	5.15984-	7126080801	152
2.55000+	0	6.51948-	7	2.60000+	0	5.09995-	7	2.65000+	0	4.53874-	7126080801	153
2.70000+	0	6.09057-	7	2.75000+	0	5.17803-	7	2.80000+	0	4.90450-	7126080801	154
2.85000+	0	5.06331-	7	2.90000+	0	4.60618-	7	2.95000+	0	4.05879-	7126080801	155
3.00000+	0	4.03010-	7	3.05000+	0	3.97749-	7	3.10000+	0	4.03107-	7126080801	156
3.15000+	0	3.74443-	7	3.20000+	0	3.57603-	7	3.25000+	0	3.44476-	7126080801	157
3.30000+	0	3.46412-	7	3.35000+	0	3.55180-	7	3.40000+	0	3.41514-	7126080801	158
3.45000+	0	3.05710-	7	3.50000+	0	3.14559-	7	3.55000+	0	4.45890-	7126080801	159
3.60000+	0	3.12349-	7	3.65000+	0	2.65416-	7	3.70000+	0	2.66305-	7126080801	160
3.75000+	0	2.53515-	7	3.80000+	0	2.60270-	7	3.85000+	0	2.18023-	7126080801	161
3.90000+	0	2.15051-	7	3.95000+	0	2.02274-	7	4.00000+	0	1.90847-	7126080801	162
4.05000+	0	2.59938-	7	4.10000+	0	2.48693-	7	4.15000+	0	1.65216-	7126080801	163
4.20000+	0	1.62644-	7	4.25000+	0	1.91800-	7	4.30000+	0	1.43424-	7126080801	164
4.35000+	0	1.62265-	7	4.40000+	0	1.46022-	7	4.45000+	0	1.31976-	7126080801	165
4.50000+	0	1.27368-	7	4.55000+	0	1.12258-	7	4.60000+	0	1.44314-	7126080801	166
4.65000+	0	1.03180-	7	4.70000+	0	9.94552-	8	4.75000+	0	9.66990-	8126080801	167
4.80000+	0	1.22519-	7	4.85000+	0	9.13387-	8	4.90000+	0	1.04046-	7126080801	168
4.95000+	0	8.76978-	8	5.00000+	0	8.39033-	8	5.05000+	0	9.43336-	8126080801	169
5.10000+	0	7.89059-	8	5.15000+	0	1.16959-	7	5.20000+	0	1.06166-	7126080801	170
5.25000+	0	7.25074-	8	5.30000+	0	8.31927-	8	5.35000+	0	7.57192-	8126080801	171
5.40000+	0	7.51120-	8	5.45000+	0	7.48414-	8	5.50000+	0	6.75483-	8126080801	172
5.55000+	0	9.66006-	8	5.60000+	0	8.68936-	8	5.65000+	0	5.32864-	8126080801	173
5.70000+	0	6.24912-	8	5.75000+	0	4.92499-	8	5.80000+	0	4.73248-	8126080801	174
5.85000+	0	5.69817-	8	5.90000+	0	5.90706-	8	5.95000+	0	4.19484-	8126080801	175
6.00000+	0	6.38761-	8	6.05000+	0	3.86347-	8	6.10000+	0	5.12524-	8126080801	176
6.15000+	0	3.53311-	8	6.20000+	0	3.64562-	8	6.25000+	0	3.19966-	8126080801	177
6.30000+	0	3.03333-	8	6.35000+	0	2.86708-	8	6.40000+	0	2.70078-	8126080801	178
6.45000+	0	2.53607-	8	6.50000+	0	2.37110-	8	6.55000+	0	2.20914-	8126080801	179
6.60000+	0	2.05022-	8	6.65000+	0	1.89296-	8	6.70000+	0	1.73852-	8126080801	180
6.75000+	0	1.58779-	8	6.80000+	0	1.44168-	8	6.85000+	0	1.29962-	8126080801	181
6.90000+	0	1.16249-	8	6.95000+	0	1.03078-	8	7.00000+	0	9.05254-	9126080801	182
7.05000+	0	7.86258-	9	7.10000+	0	6.74297-	9	7.15000+	0	5.70479-	9126080801	183
7.20000+	0	4.74928-	9	7.25000+	0	3.88349-	9	7.30000+	0	3.11546-	9126080801	184
7.35000+	0	2.45098-	9	7.40000+	0	1.89511-	9	7.45000+	0	1.45745-	9126080801	185
7.50000+	0	0.00000+	0	0.00000+	0	0.00000+	0	0.00000+	0	0.00000+	0126080801	186
0.	151	1.0000E+00	1	0	0	0	0	0	1	151	126080801	187
0.00000+	0	2.26492-	9	5.00000-	2	2.15502-	8	1.00000-	1	4.84493-	7126080801	188
1.50000-	1	7.56923-	8	2.00000-	1	1.18797-	7	2.50000-	1	3.05972-	7126080801	189
3.00000-	1	7.99345-	8	3.50000-	1	2.97594-	7	4.00000-	1	2.12042-	7126080801	190
4.50000-	1	7.47052-	7	5.00000-	1	1.46985-	6	5.50000-	1	9.40471-	7126080801	191
6.00000-	1	5.83778-	7	6.50000-	1	1.69459-	7	7.00000-	1	2.86716-	7126080801	192
7.50000-	1	2.28526-	7	8.00000-	1	2.49908-	6	8.50000-	1	2.02954-	7126080801	193
9.00000-	1	2.65891-	7	9.50000-	1	4.00354-	7	1.00000+	0	2.29798-	7126080801	194
1.05000+	0	3.21108-	7	1.10000+	0	6.53882-	7	1.15000+	0	2.28254-	7126080801	195
1.20000+	0	5.73030-	7	1.25000+	0	5.17760-	7	1.30000+	0	5.97338-	7126080801	196
1.35000+	0	3.16793-	7	1.40000+	0	8.11975-	7	1.45000+	0	4.05593-	7126080801	197
1.50000+	0	4.55505-	7	1.55000+	0	4.00287-	7	1.60000+	0	3.45367-	7126080801	198
1.65000+	0	3.46689-	7	1.70000+	0	3.60276-	7	1.75000+	0	4.22214-	7126080801	199
1.80000+	0	3.41701-	7	1.85000+	0	3.84276-	7	1.90000+	0	3.52331-	7126080801	200
1.95000+	0	4.23325-	7	2.00000+	0	3.81795-	7	2.05000+	0	3.53866-	7126080801	201
2.10000+	0	3.93804-	7	2.15000+	0	3.55441-	7	2.20000+	0	3.79168-	7126080801	202
2.25000+	0	3.93734-	7	2.30000+	0	4.04943-	7	2.35000+	0	3.61324-	7126080801	203
2.40000+	0	3.93488-	7	2.45000+	0	4.81048-	7	2.50000+	0	3.97479-	7126080801	204
2.55000+	0	5.15620-	7	2.60000+	0	3.91242-	7	2.65000+	0	3.42648-	7126080801	205
2.70000+	0	4.64253-	7	2.75000+	0	3.97334-	7	2.80000+	0	3.68800-	7126080801	206
2.85000+	0	3.89169-	7	2.90000+	0	3.49909-	7	2.95000+	0	3.03171-	7126080801	207
3.00000+	0	3.01567-	7	3.05000+	0	2.96855-	7	3.10000+	0	3.01729-	7126080801	208
3.15000+	0	2.77193-	7	3.20000+	0	2.65702-	7	3.25000+	0	2.55153-	7126080801	209
3.30000+	0	2.58275-	7	3.35000+	0	2.68215-	7	3.40000+	0	2.56780-	7126080801	210
3.45000+	0	2.26613-	7	3.50000+	0	2.35814-	7	3.55000+	0	3.53666-	7126080801	211
3.60000+	0	2.36872-	7	3.65000+	0	1.95900-	7	3.70000+	0	1.99009-	7126080801	212
3.75000+	0	1.89504-	7	3.80000+	0	1.96659-	7	3.85000+	0	1.61249-	7126080801	213
3.90000+	0	1.60147-	7	3.95000+	0	1.50372-	7	4.00000+	0	1.41816-	7126080801	214
4.05000+	0	2.04587-	7	4.10000+	0	1.96194-	7	4.15000+	0	1.23773-	7126080801	215
4.20000+	0	1.22564-	7	4.25000+	0	1.50287-	7	4.30000+	0	1.08897-	7126080801	216
4.35000+	0	1.27949-	7	4.40000+	0	1.11911-	7	4.45000+	0	1.02566-	7126080801	217
4.50000+	0	9.85953-	8	4.55000+	0	8.71000-	8	4.60000+	0	1.13265-	7126080801	218
4.65000+	0	8.05929-	8	4.70000+	0	7.78551-	8	4.75000+	0	7.58134-	8126080801	219
												220



4.80000+	0	9.56352-	8	4.85000+	0	7.15442-	8	4.90000+	0	8.12660-	8126080801	221
4.95000+	0	6.88224-	8	5.00000+	0	6.56673-	8	5.05000+	0	7.37341-	8126080801	222
5.10000+	0	6.17259-	8	5.15000+	0	9.16173-	8	5.20000+	0	8.26073-	8126080801	223
5.25000+	0	5.68298-	8	5.30000+	0	6.51236-	8	5.35000+	0	5.90620-	8126080801	224
5.40000+	0	5.99468-	8	5.45000+	0	5.83105-	8	5.50000+	0	5.36706-	8126080801	225
5.55000+	0	7.49781-	8	5.60000+	0	6.74761-	8	5.65000+	0	4.15881-	8126080801	226
5.70000+	0	4.86349-	8	5.75000+	0	3.84118-	8	5.80000+	0	3.68935-	8126080801	227
5.85000+	0	4.42823-	8	5.90000+	0	4.58454-	8	5.95000+	0	3.26280-	8126080801	228
6.00000+	0	4.94515-	8	6.05000+	0	2.99906-	8	6.10000+	0	3.96562-	8126080801	229
6.15000+	0	2.73685-	8	6.20000+	0	2.85558-	8	6.25000+	0	2.47263-	8126080801	230
6.30000+	0	2.34107-	8	6.35000+	0	2.20964-	8	6.40000+	0	2.07825-	8126080801	231
6.45000+	0	1.94814-	8	6.50000+	0	1.81798-	8	6.55000+	0	1.69027-	8126080801	232
6.60000+	0	1.5504-	8	6.65000+	0	1.44118-	8	6.70000+	0	1.31969-	8126080801	233
6.75000+	0	1.20126-	8	6.80000+	0	1.08651-	8	6.85000+	0	9.75117-	9126080801	234
6.90000+	0	8.67737-	9	6.95000+	0	7.64753-	9	7.00000+	0	6.66728-	9126080801	235
7.05000+	0	5.74013-	9	7.10000+	0	4.87027-	9	7.15000+	0	4.06578-	9126080801	236
7.20000+	0	3.32824-	9	7.25000+	0	2.66288-	9	7.30000+	0	2.07576-	9126080801	237
7.35000+	0	1.57180-	9	7.40000+	0	1.15524-	9	7.45000+	0	8.33118-	10126080801	238
7.50000+	0	0.00000+	0	0.00000+	0	0.00000+	0	0.00000+	0	0.00000+	0126080801	239

.....

CARDS 241 THROUGH 2614 HAVE BEEN DELETED

0.	1.0000E+10	0	0	1	128126080802	2391					
0.00000+	0	2.62687-20	5.00000-	2	7.59349-20	1.00000-	1	1.18238-19	126080802	2392	
1.50000-	1	1.48846-19	2.00000-	1	1.64537-19	2.50000-	1	1.63824-19	126080802	2393	
3.00000-	1	1.47501-19	3.50000-	1	1.19179-19	4.00000-	1	8.56247-20	126080802	2395	
4.50000-	1	5.71523-20	5.00000-	1	4.64209-20	5.50000-	1	4.98998-20	126080802	2396	
6.00000-	1	5.50279-20	6.50000-	1	5.99656-20	7.00000-	1	6.46032-20	126080802	2397	
7.50000-	1	6.89034-20	8.00000-	1	7.28429-20	8.50000-	1	7.63553-20	126080802	2398	
9.00000-	1	7.94316-20	9.50000-	1	8.20473-20	1.00000+	0	8.41913-20	126080802	2399	
1.05000+	0	8.59344-20	1.10000+	0	8.72411-20	1.15000+	0	8.82190-20	126080802	2400	
1.20000+	0	8.86887-20	1.25000+	0	8.84739-20	1.30000+	0	8.75936-20	126080802	2401	
1.35000+	0	8.59763-20	1.40000+	0	8.36650-20	1.45000+	0	8.06610-20	126080802	2402	
1.50000+	0	7.69882-20	1.55000+	0	7.26689-20	1.60000+	0	6.77931-20	126080802	2403	
1.65000+	0	6.23855-20	1.70000+	0	5.65152-20	1.75000+	0	5.02984-20	126080802	2404	
1.80000+	0	4.38504-20	1.85000+	0	3.72642-20	1.90000+	0	3.06780-20	126080802	2405	
1.95000+	0	2.42776-20	2.00000+	0	1.82263-20	2.05000+	0	1.27069-20	126080802	2406	
2.10000+	0	7.93938-21	2.15000+	0	4.15731-21	2.20000+	0	1.61147-21	126080802	2407	
2.25000+	0	5.60890-22	2.30000+	0	4.72857-22	2.35000+	0	4.46707-22	126080802	2408	
2.40000+	0	4.22678-22	2.45000+	0	4.00006-22	2.50000+	0	3.78048-22	126080802	2409	
2.55000+	0	3.56966-22	2.60000+	0	3.36820-22	2.65000+	0	3.17824-22	126080802	2410	
2.70000+	0	2.99892-22	2.75000+	0	2.83290-22	2.80000+	0	2.68235-22	126080802	2411	
2.85000+	0	2.54542-22	2.90000+	0	2.41618-22	2.95000+	0	2.29227-22	126080802	2412	
3.00000+	0	2.17305-22	3.05000+	0	2.05657-22	3.10000+	0	1.94060-22	126080802	2413	
3.15000+	0	1.82617-22	3.20000+	0	1.71378-22	3.25000+	0	1.60396-22	126080802	2414	
3.30000+	0	1.49924-22	3.35000+	0	1.40013-22	3.40000+	0	1.30714-22	126080802	2415	
3.45000+	0	1.21927-22	3.50000+	0	1.13704-22	3.55000+	0	1.05940-22	126080802	2416	
3.60000+	0	9.87862-23	3.65000+	0	9.20381-23	3.70000+	0	8.55944-23	126080802	2417	
3.75000+	0	7.96074-23	3.80000+	0	7.41277-23	3.85000+	0	6.91554-23	126080802	2418	
3.90000+	0	6.46398-23	3.95000+	0	6.03271-23	4.00000+	0	5.61159-23	126080802	2419	
4.05000+	0	5.19046-23	4.10000+	0	4.78405-23	4.15000+	0	4.38881-23	126080802	2420	
4.20000+	0	4.00574-23	4.25000+	0	3.63891-23	4.30000+	0	3.29287-23	126080802	2421	
4.35000+	0	2.96460-23	4.40000+	0	2.66018-23	4.45000+	0	2.37909-23	126080802	2422	
4.50000+	0	2.12134-23	4.55000+	0	1.87780-23	4.60000+	0	1.64694-23	126080802	2423	
4.65000+	0	1.43080-23	4.70000+	0	1.22887-23	4.75000+	0	1.04063-23	126080802	2424	
4.80000+	0	8.68122-24	4.85000+	0	7.12864-24	4.90000+	0	5.70799-24	126080802	2425	
4.95000+	0	4.41113-24	5.00000+	0	3.24721-24	5.05000+	0	2.23652-24	126080802	2426	
5.10000+	0	1.39326-24	5.15000+	0	7.34174-25	5.20000+	0	2.77078-25	126080802	2427	
5.25000+	0	3.99661-26	5.30000+	0	1.72721-29	5.35000+	0	1.54251-29	126080802	2428	
5.40000+	0	1.38065-29	5.45000+	0	1.24466-29	5.50000+	0	1.12796-29	126080802	2429	
5.55000+	0	1.01582-29	5.60000+	0	9.06223-30	5.65000+	0	7.99668-30	126080802	2430	
5.70000+	0	6.97680-30	5.75000+	0	5.99244-30	5.80000+	0	5.06541-30	126080802	2431	
5.85000+	0	4.19268-30	5.90000+	0	3.38286-30	5.95000+	0	2.64256-30	126080802	2432	
6.00000+	0	1.97786-30	6.05000+	0	1.39739-30	6.10000+	0	9.06734-31	126080802	2433	
6.15000+	0	5.15019-31	6.20000+	0	2.28692-31	6.25000+	0	5.62260-32	126080802	2434	
6.30000+	0	1.35725-33	6.35000+	0	0.00000+	0.00000+	0	0.00000+	0126080802	2435	
									126080	0	2436
9.2233E+04	2.3104E+02	0	0	0	0	0	0	0	0126080803	2437	
0.	0.	0	0	0	0	0	0	0	24126080803	2438	
	24	0	0	0	0	0	0	0	0126080803	2439	
0.	0.	0	0	0	0	1	1	1	126126080803	2440	
	126	1	0	0	0	0	0	0	0126080803	2441	

0.00000+	0	1.00278-	9	5.00000-	2	2.39510-	8	1.00000-	1	1.58209-	6126080803	2442
1.50000-	1	1.05556-	7	2.00000-	1	1.67180-	7	2.50000-	1	4.81025-	7126080803	2443
3.00000-	1	9.04815-	8	3.50000-	1	4.47521-	7	4.00000-	1	3.74279-	7126080803	2444
4.50000-	1	1.69324-	6	5.00000-	1	3.02416-	6	5.50000-	1	2.11812-	6126080803	2445
6.00000-	1	8.74489-	7	6.50000-	1	1.26381-	7	7.00000-	1	3.14333-	7126080803	2446
7.50000-	1	1.94761-	7	8.00000-	1	8.61656-	6	8.50000-	1	1.33535-	7126080803	2447
9.00000-	1	1.92402-	7	9.50000-	1	4.23937-	7	1.00000+	0	1.27350-	7126080803	2448
1.05000+	0	2.47845-	7	1.10000+	0	8.09259-	7	1.15000+	0	4.74744-	8126080803	2449
1.20000+	0	1.06273-	6	1.25000+	0	5.54597-	7	1.30000+	0	5.98311-	7126080803	2450
1.35000+	0	1.55368-	7	1.40000+	0	8.83268-	7	1.45000+	0	2.38739-	7126080803	2451
1.50000+	0	3.10599-	7	1.55000+	0	2.07555-	7	1.60000+	0	9.34039-	8126080803	2452
1.65000+	0	9.01150-	8	1.70000+	0	1.08041-	7	1.75000+	0	1.95199-	7126080803	2453
1.80000+	0	4.85068-	8	1.85000+	0	1.20048-	7	1.90000+	0	4.69788-	8126080803	2454
1.95000+	0	1.50992-	7	2.00000+	0	8.49840-	8	2.05000+	0	3.64497-	8126080803	2455
2.10000+	0	8.8952-	8	2.15000+	0	2.36484-	8	2.20000+	0	5.82171-	8126080803	2456
2.25000+	0	7.86127-	8	2.30000+	0	9.24277-	8	2.35000+	0	3.00445-	8126080803	2457
2.40000+	0	8.69120-	8	2.45000+	0	2.88929-	7	2.50000+	0	8.53716-	8126080803	2458
2.55000+	0	2.67171-	7	2.60000+	0	8.69149-	8	2.65000+	0	1.88152-	8126080803	2459
2.70000+	0	2.67302-	7	2.75000+	0	1.20867-	7	2.80000+	0	1.08168-	7126080803	2460
2.85000+	0	1.18599-	7	2.90000+	0	7.04789-	8	2.95000+	0	9.35042-	9126080803	2461
3.00000+	0	1.67824-	8	3.05000+	0	2.54355-	8	3.10000+	0	4.73117-	8126080803	2462
3.15000+	0	2.53853-	8	3.20000+	0	1.03002-	8	3.25000+	0	8.00246-	9126080803	2463
3.30000+	0	2.40287-	8	3.35000+	0	4.64227-	8	3.40000+	0	4.42268-	8126080803	2464
3.45000+	0	1.18195-	8	3.50000+	0	3.61110-	8	3.55000+	0	2.14223-	7126080803	2465
3.60000+	0	5.85414-	8	3.65000+	0	1.51213-	8	3.70000+	0	2.67114-	8126080803	2466
3.75000+	0	2.24004-	8	3.80000+	0	4.43683-	8	3.85000+	0	1.58340-	9126080803	2467
3.90000+	0	9.40291-	9	3.95000+	0	4.61386-	9	4.00000+	0	1.32360-	9126080803	2468
4.05000+	0	9.95371-	8	4.10000+	0	9.62682-	8	4.15000+	0	9.59363-	10126080803	2469
4.20000+	0	8.96530-	9	4.25000+	0	5.39655-	8	4.30000+	0	1.78966-	9126080803	2470
4.35000+	0	3.16658-	8	4.40000+	0	2.71796-	8	4.45000+	0	1.15920-	8126080803	2471
4.50000+	0	1.56279-	8	4.55000+	0	3.59493-	10	4.60000+	0	5.57777-	8126080803	2472
4.65000+	0	1.41135-	10	4.70000+	0	8.09831-	11	4.75000+	0	5.02067-	10126080803	2473
4.80000+	0	4.58343-	8	4.85000+	0	1.52613-	13	4.90000+	0	2.42415-	8126080803	2474
4.95000+	0	1.54002-	9	5.00000+	0	0.00000+	0	5.05000+	0	2.04265-	8126080803	2475
5.10000+	0	0.00000+	0	5.15000+	0	6.30125-	8	5.20000+	0	5.15273-	8126080803	2476
5.25000+	0	1.18260-	9	5.30000+	0	2.18161-	8	5.35000+	0	1.44444-	8126080803	2477
5.40000+	0	1.33185-	8	5.45000+	0	2.05113-	8	5.50000+	0	9.64536-	9126080803	2478
5.55000+	0	6.24788-	8	5.60000+	0	5.04117-	8	5.65000+	0	0.00000+	0126080803	2479
5.70000+	0	1.79852-	8	5.75000+	0	0.00000+	0	5.80000+	0	0.00000+	0126080803	2480
5.85000+	0	1.84244-	8	5.90000+	0	2.46557-	8	5.95000+	0	0.00000+	0126080803	2481
6.00000+	0	3.77199-	8	6.05000+	0	0.00000+	0	6.10000+	0	2.28129-	8126080803	2482
6.15000+	0	0.00000+	0	6.20000+	0	3.45399-	9	6.25000+	0	0.00000+	0126080803	2483
0.		1.0000E-01		0		0		0		1	126126080803	2484
	126		1		0		0		0		0126080803	2485
0.00000+	0	9.47900-	10	5.00000-	2	2.24606-	8	1.00000-	1	1.33762-	6126080803	2486
1.50000-	1	9.63787-	8	2.00000-	1	1.53026-	7	2.50000-	1	4.40267-	7126080803	2487
3.00000-	1	8.11603-	8	3.50000-	1	4.08685-	7	4.00000-	1	3.28200-	7126080803	2488
4.50000-	1	1.47133-	6	5.00000-	1	2.67428-	6	5.50000-	1	1.84107-	6126080803	2489
6.00000-	1	7.97344-	7	6.50000-	1	1.16271-	7	7.00000-	1	2.87655-	7126080803	2490
7.50000-	1	1.78941-	7	8.00000-	1	7.23796-	6	8.50000-	1	1.19678-	7126080803	2491
9.00000-	1	1.78072-	7	9.50000-	1	3.87274-	7	1.00000+	0	1.13461-	7126080803	2492
1.05000+	0	2.26787-	7	1.10000+	0	7.37350-	7	1.15000+	0	4.40893-	8126080803	2493
1.20000+	0	9.04235-	7	1.25000+	0	5.01665-	7	1.30000+	0	5.50340-	7126080803	2494
1.35000+	0	1.38586-	7	1.40000+	0	8.17702-	7	1.45000+	0	2.20448-	7126080803	2495
1.50000+	0	2.85848-	7	1.55000+	0	1.90908-	7	1.60000+	0	8.74013-	8126080803	2496
1.65000+	0	8.34035-	8	1.70000+	0	9.88193-	8	1.75000+	0	1.79412-	7126080803	2497
1.80000+	0	4.52166-	8	1.85000+	0	1.09195-	7	1.90000+	0	4.38746-	8126080803	2498
1.95000+	0	1.39948-	7	2.00000+	0	7.80210-	8	2.05000+	0	3.30073-	8126080803	2499
2.10000+	0	8.24105-	8	2.15000+	0	2.22096-	8	2.20000+	0	5.42050-	8126080803	2500
2.25000+	0	7.30974-	8	2.30000+	0	8.63695-	8	2.35000+	0	2.78345-	8126080803	2501
2.40000+	0	7.95526-	8	2.45000+	0	2.57096-	7	2.50000+	0	8.01738-	8126080803	2502
2.55000+	0	2.49300-	7	2.60000+	0	8.12703-	8	2.65000+	0	1.78124-	8126080803	2503
2.70000+	0	2.39891-	7	2.75000+	0	1.11649-	7	2.80000+	0	9.63202-	8126080803	2504
2.85000+	0	1.10834-	7	2.90000+	0	6.55727-	8	2.95000+	0	8.74601-	9126080803	2505
3.00000+	0	1.57947-	8	3.05000+	0	2.30595-	8	3.10000+	0	4.29939-	8126080803	2506
3.15000+	0	2.20378-	8	3.20000+	0	9.64940-	9	3.25000+	0	7.30503-	9126080803	2507
3.30000+	0	2.23519-	8	3.35000+	0	4.39480-	8	3.40000+	0	4.15002-	8126080803	2508
3.45000+	0	1.11143-	8	3.50000+	0	3.38102-	8	3.55000+	0	2.01320-	7126080803	2509
3.60000+	0	5.49951-	8	3.65000+	0	1.34546-	8	3.70000+	0	2.49056-	8126080803	2510
3.75000+	0	2.10434-	8	3.80000+	0	4.13932-	8	3.85000+	0	1.50789-	9126080803	2511
3.90000+	0	8.83334-	9	3.95000+	0	4.32790-	9	4.00000+	0	1.24189-	9126080803	2512
4.05000+	0	9.35422-	8	4.10000+	0	9.03821-	8	4.15000+	0	9.00380-	10126080803	2513
4.20000+	0	8.10373-	9	4.25000+	0	5.07110-	8	4.30000+	0	1.69697-	9126080803	2514
4.35000+	0	3.03356-	8	4.40000+	0	2.42044-	8	4.45000+	0	1.09112-	8126080803	2515
4.50000+	0	1.40228-	8	4.55000+	0	3.37754-	10	4.60000+	0	5.01850-	8126080803	2516

4.65000+	0	1.32383-10	4.70000+	0	7.59928-11	4.75000+	0	4.71706-10	126126080803	2517	
4.80000+	0	4.07213-8	4.85000+	0	1.45534-13	4.90000+	0	2.15235-8	126126080803	2518	
4.95000+	0	1.46631-9	5.00000+	0	0.00000+	0	5.05000+	0	1.81852-8	126126080803	2519
5.10000+	0	0.00000+	0	5.15000+	0	5.62981-8	5.20000+	0	4.57501-8	126126080803	2520
5.25000+	0	1.13364-9	5.30000+	0	1.95142-8	5.35000+	0	1.28249-8	126126080803	2521	
5.40000+	0	1.25797-8	5.45000+	0	1.82116-8	5.50000+	0	9.11029-9	126126080803	2522	
5.55000+	0	5.54737-8	5.60000+	0	4.47597-8	5.65000+	0	0.00000+	0126080803	2523	
5.70000+	0	1.59689-8	5.75000+	0	0.00000+	0	5.80000+	0	0.00000+	0126080803	2524
5.85000+	0	1.63587-8	5.90000+	0	2.18914-8	5.95000+	0	0.00000+	0126080803	2525	
6.00000+	0	3.34905-8	6.05000+	0	0.00000+	0	6.10000+	0	2.02551-8	126126080803	2526
6.15000+	0	0.00000+	0	6.20000+	0	3.26238-9	6.25000+	0	0.00000+	0126080803	2527
0.		5.0000E-01		0	0	0	0	1	126126080803	2528	
	126	1		0	0	0	0	0	0126080803	2529	
0.00000+	0	8.15100-10	5.00000-	2	1.87991-8	1.00000-	1	7.70253-7	126126080803	2530	
1.50000-	1	7.44405-8	2.00000-	1	1.19118-7	2.50000-	1	3.40783-7	126126080803	2531	
3.00000-	1	5.95032-8	3.50000-	1	3.14531-7	4.00000-	1	2.21722-7	126126080803	2532	
4.50000-	1	9.60548-7	5.00000-	1	1.85542-6	5.50000-	1	1.20328-6	126126080803	2533	
6.00000-	1	6.11400-7	6.50000-	1	9.20274-8	7.00000-	1	2.23260-7	126126080803	2534	
7.50000-	1	1.40279-7	8.00000-	1	4.03656-6	8.50000-	1	8.74589-8	126126080803	2535	
9.00000-	1	1.43242-7	9.50000-	1	2.98603-7	1.00000+	0	8.14227-8	126126080803	2536	
1.05000+	0	1.75682-7	1.10000+	0	5.65783-7	1.15000+	0	3.58770-8	126126080803	2537	
1.20000+	0	5.44968-7	1.25000+	0	3.74354-7	1.30000+	0	4.35672-8	126126080803	2538	
1.35000+	0	9.97454-8	1.40000+	0	6.59104-7	1.45000+	0	1.76010-8	126126080803	2539	
1.50000+	0	2.26002-7	1.55000+	0	1.50706-7	1.60000+	0	7.27988-8	126126080803	2540	
1.65000+	0	6.72331-8	1.70000+	0	7.67980-8	1.75000+	0	1.41484-8	126126080803	2541	
1.80000+	0	3.72471-8	1.85000+	0	8.35688-8	1.90000+	0	3.63455-8	126126080803	2542	
1.95000+	0	1.13419-7	2.00000+	0	6.14774-8	2.05000+	0	2.49227-8	126126080803	2543	
2.10000+	0	6.66550-8	2.15000+	0	1.87239-8	2.20000+	0	4.44710-8	126126080803	2544	
2.25000+	0	5.98587-8	2.30000+	0	7.16689-8	2.35000+	0	2.25146-8	126126080803	2545	
2.40000+	0	6.21398-8	2.45000+	0	1.82387-7	2.50000+	0	6.74070-8	126126080803	2546	
2.55000+	0	2.05992-7	2.60000+	0	6.73208-8	2.65000+	0	1.52325-8	126126080803	2547	
2.70000+	0	1.75228-7	2.75000+	0	8.96036-8	2.80000+	0	6.86210-8	126126080803	2548	
2.85000+	0	9.16054-8	2.90000+	0	5.36608-8	2.95000+	0	7.27793-8	126126080803	2549	
3.00000+	0	1.33531-8	3.05000+	0	1.75105-8	3.10000+	0	3.27997-8	126126080803	2550	
3.15000+	0	1.43989-8	3.20000+	0	8.06604-9	3.25000+	0	5.67863-8	126126080803	2551	
3.30000+	0	1.83771-8	3.35000+	0	3.79060-8	3.40000+	0	3.48333-8	126126080803	2552	
3.45000+	0	9.39279-9	3.50000+	0	2.82651-8	3.55000+	0	1.69700-8	126126080803	2553	
3.60000+	0	4.63088-8	3.65000+	0	9.57858-9	3.70000+	0	2.05425-8	126126080803	2554	
3.75000+	0	1.77222-8	3.80000+	0	3.41796-8	3.85000+	0	1.32272-8	126126080803	2555	
3.90000+	0	7.44450-9	3.95000+	0	3.63133-9	4.00000+	0	1.04277-8	126126080803	2556	
4.05000+	0	7.88514-8	4.10000+	0	7.60458-8	4.15000+	0	7.56604-10	126126080803	2557	
4.20000+	0	6.07230-9	4.25000+	0	4.27353-8	4.30000+	0	1.47011-8	126126080803	2558	
4.35000+	0	2.70584-8	4.40000+	0	1.72268-8	4.45000+	0	9.24326-9	126126080803	2559	
4.50000+	0	1.02458-8	4.55000+	0	2.84693-10	4.60000+	0	3.70362-8	126126080803	2560	
4.65000+	0	1.11065-10	4.70000+	0	6.38434-11	4.75000+	0	3.97601-10	126126080803	2561	
4.80000+	0	2.87408-8	4.85000+	0	1.28770-13	4.90000+	0	1.51566-8	126126080803	2562	
4.95000+	0	1.28539-9	5.00000+	0	0.00000+	0	5.05000+	0	1.29313-8	126126080803	2563
5.10000+	0	0.00000+	0	5.15000+	0	4.05441-8	5.20000+	0	3.22168-8	126126080803	2564
5.25000+	0	1.01298-9	5.30000+	0	1.41115-8	5.35000+	0	9.03131-9	126126080803	2565	
5.40000+	0	1.07773-8	5.45000+	0	1.28243-8	5.50000+	0	7.80498-8	126126080803	2566	
5.55000+	0	3.90640-8	5.60000+	0	3.15198-8	5.65000+	0	0.00000+	0126080803	2567	
5.70000+	0	1.12456-8	5.75000+	0	0.00000+	0	5.80000+	0	0.00000+	0126080803	2568
5.85000+	0	1.15197-8	5.90000+	0	1.54160-8	5.95000+	0	0.00000+	0126080803	2569	
6.00000+	0	2.35831-8	6.05000+	0	0.00000+	0	6.10000+	0	1.42635-8	126126080803	2570
6.15000+	0	0.00000+	0	6.20000+	0	2.79495-9	6.25000+	0	0.00000+	0126080803	2571
0.		1.0000E+00		0	0	0	0	1	126126080803	2572	
	126	1		0	0	0	0	0	0126080803	2573	
0.00000+	0	7.35883-10	5.00000-	2	1.65434-8	1.00000-	1	4.75355-7	126126080803	2574	
1.50000-	1	6.17738-8	2.00000-	1	9.94398-8	2.50000-	1	2.80547-7	126126080803	2575	
3.00000-	1	4.78762-8	3.50000-	1	2.58384-7	4.00000-	1	1.65188-7	126126080803	2576	
4.50000-	1	6.92076-7	5.00000-	1	1.40630-6	5.50000-	1	8.67935-7	126126080803	2577	
6.00000-	1	5.01897-7	6.50000-	1	7.79116-8	7.00000-	1	1.85215-7	126126080803	2578	
7.50000-	1	1.16787-7	8.00000-	1	2.37689-6	8.50000-	1	7.01330-7	126126080803	2579	
9.00000-	1	1.22312-7	9.50000-	1	2.45959-7	1.00000+	0	6.45606-8	126126080803	2580	
1.05000+	0	1.45101-7	1.10000+	0	4.67193-7	1.15000+	0	3.09628-8	126126080803	2581	
1.20000+	0	3.65307-7	1.25000+	0	2.99822-7	1.30000+	0	3.69399-8	126126080803	2582	
1.35000+	0	7.91064-8	1.40000+	0	5.64842-7	1.45000+	0	1.49342-8	126126080803	2583	
1.50000+	0	1.90486-7	1.55000+	0	1.26910-7	1.60000+	0	6.39902-8	126126080803	2584	
1.65000+	0	5.77124-8	1.70000+	0	6.41032-8	1.75000+	0	1.19309-8	126126080803	2585	
1.80000+	0	3.24894-8	1.85000+	0	6.92114-8	1.90000+	0	3.18362-8	126126080803	2586	
1.95000+	0	9.78978-8	2.00000+	0	5.20592-8	2.05000+	0	2.04573-8	126126080803	2587	
2.10000+	0	5.73782-8	2.15000+	0	1.66398-8	2.20000+	0	3.86391-8	126126080803	2588	
2.25000+	0	5.21162-8	2.30000+	0	6.28514-8	2.35000+	0	1.93871-8	126126080803	2589	
2.40000+	0	5.23239-8	2.45000+	0	1.41236-7	2.50000+	0	5.95396-8	126126080803	2590	
2.55000+	0	1.80112-7	2.60000+	0	5.86366-8	2.65000+	0	1.34909-8	126126080803	2591	

2.70000+	0	1.39131-	7	2.75000+	0	7.68465-	8	2.80000+	0	5.34918-	8126080803	2592
2.85000+	0	7.95785-	8	2.90000+	0	4.65150-	8	2.95000+	0	6.39501-	9126080803	2593
3.00000+	0	1.18287-	8	3.05000+	0	1.44865-	8	3.10000+	0	2.70875-	8126080803	2594
3.15000+	0	1.05018-	8	3.20000+	0	7.11011-	9	3.25000+	0	4.79522-	9126080803	2595
3.30000+	0	1.61231-	8	3.35000+	0	3.42213-	8	3.40000+	0	3.07637-	8126080803	2596
3.45000+	0	8.34446-	9	3.50000+	0	2.49882-	8	3.55000+	0	1.50303-	7126080803	2597
3.60000+	0	4.09861-	8	3.65000+	0	7.49189-	9	3.70000+	0	1.79534-	8126080803	2598
3.75000+	0	1.56906-	8	3.80000+	0	2.98617-	8	3.85000+	0	1.20852-	9126080803	2599
3.90000+	0	6.60155-	9	3.95000+	0	3.21000-	9	4.00000+	0	9.22213-	10126080803	2600
4.05000+	0	6.98402-	8	4.10000+	0	6.73739-	8	4.15000+	0	6.69447-	10126080803	2601
4.20000+	0	4.93708-	9	4.25000+	0	3.78431-	8	4.30000+	0	1.33103-	9126080803	2602
4.35000+	0	2.50117-	8	4.40000+	0	1.33827-	8	4.45000+	0	8.22019-	9126080803	2603
4.50000+	0	8.14649-	9	4.55000+	0	2.52396-	10	4.60000+	0	2.97419-	8126080803	2604
4.65000+	0	9.81695-	11	4.70000+	0	5.65034-	11	4.75000+	0	3.52494-	10126080803	2605
4.80000+	0	2.21571-	8	4.85000+	0	1.19310-	13	4.90000+	0	1.16600-	8126080803	2606
4.95000+	0	1.17353-	9	5.00000+	0	0.00000+	0	5.05000+	0	1.00406-	8126080803	2607
5.10000+	0	0.00000+	0	5.15000+	0	3.18536-	8	5.20000+	0	2.47845-	8126080803	2608
5.25000+	0	9.37530-	10	5.30000+	0	1.11285-	8	5.35000+	0	6.94788-	9126080803	2609
5.40000+	0	9.68201-	9	5.45000+	0	9.86578-	9	5.50000+	0	7.01173-	9126080803	2610
5.55000+	0	3.00521-	8	5.60000+	0	2.42486-	8	5.65000+	0	0.00000+	0126080803	2611
5.70000+	0	8.65154-	9	5.75000+	0	0.00000+	0	5.80000+	0	0.00000+	0126080803	2612
5.85000+	0	8.86221-	9	5.90000+	0	1.18598-	8	5.95000+	0	0.00000+	0126080803	2613
6.00000+	0	1.81423-	8	6.05000+	0	0.00000+	0	6.10000+	0	1.09730-	8126080803	2614
6.15000+	0	0.00000+	0	6.20000+	0	2.51089-	9	6.25000+	0	0.00000+	0126080803	2615

REMAINING CARDS IN THE FILE HAVE BEEN DELETED

Printed in the United States of America. Available from  
 National Technical Information Service  
 U.S. Department of Commerce  
 5185 Port Royal Road  
 Springfield, VA 22161

Microfiche \$3.00

001-025	4.00	126-150	7.25	251-275	10.75	376-400	13.00	501-525	15.25
026-050	4.50	151-175	8.00	276-300	11.00	401-425	13.25	526-550	15.50
051-075	5.25	176-200	9.00	301-325	11.75	426-450	14.00	551-575	16.25
076-100	6.00	201-225	9.25	326-350	12.00	451-475	14.50	576-600	16.50
101-125	6.50	226-250	9.50	351-375	12.50	476-500	15.00	601-up	

Note: Add \$2.50 for each additional 100-page increment from 601 pages up.