

EA9642

CIC-14 REPORT COLLECTION
**REPRODUCTION
COPY**

Los Alamos National Laboratory is operated by the University of California for the United States Department of Energy under contract W-7405-ENG-36.

*Background-Subtract Adjustment for
Plutonium Continuous Alpha Air
Monitors Using ²⁵²Cf*

LOS ALAMOS NATIONAL LABORATORY



3 9338 00308 4075

Los Alamos Los Alamos National Laboratory
Los Alamos, New Mexico 87545

Edited by Elaine Stanlick
Photocomposition by Chris West and Pamela H. Mayne

DISCLAIMER

This report was prepared as an account of work sponsored by an agency of the United States Government. Neither the United States Government nor any agency thereof, nor any of their employees, makes any warranty, express or implied, or assumes any legal liability or responsibility for the accuracy, completeness, or usefulness of any information, apparatus, product, or process disclosed, or represents that its use would not infringe privately owned rights. Reference herein to any specific commercial product, process, or service by trade name, trademark, manufacturer, or otherwise, does not necessarily constitute or imply its endorsement, recommendation, or favoring by the United States Government or any agency thereof. The views and opinions of authors expressed herein do not necessarily state or reflect those of the United States Government or any agency thereof.

LA-9642

UC-41

Issued: August 1983

Background-Subtract Adjustment for Plutonium Continuous Alpha Air Monitors Using ^{252}Cf

Alfred L. Cucchiara
Ronald G. Stafford
James L. McAtee

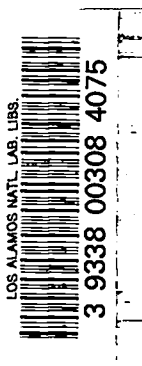

Los Alamos Los Alamos National Laboratory
Los Alamos, New Mexico 87545

BACKGROUND-SUBTRACT ADJUSTMENT FOR PLUTONIUM CONTINUOUS ALPHA AIR MONITORS USING ^{252}Cf

by

Alfred L. Cucchiara, Ronald G. Stafford,
and James L. McAtee

ABSTRACT

We investigated a method to make optimum adjustments to the electronic background-subtract circuit of a continuous air monitor (CAM) by using a californium source instead of a background air sample. We observed spectra of detected alpha particles emitted by radon-thoron daughters and a californium source on a multichannel analyzer connected to a CAM to determine their effect on the behavior of the subtract circuit. The californium source alpha energy spectrum simulates the spectra of ^{218}Po and ^{212}Bi , the radon-thoron daughters most likely to cause spurious CAM alarms. This simulation was the basis for deriving an empirical method using californium to adjust the background-subtract circuit.

I. INTRODUCTION

Continuous alpha air monitors (CAMs) are often used to monitor the air in areas where a potential for airborne alpha-emitting radioactive contamination exists. If a significant amount of certain alpha emitters are released in the air, the CAM detects their presence and an audible alarm alerts personnel to evacuate the area. At the Los Alamos National Laboratory, commercially available CAMs* are used for this purpose.

Though several different CAM models are used, their basic operating principles are similar to those shown in Fig. 1. Air drawn from the monitored area is passed through a filter and particulates are deposited on its surface. A silicon surface-barrier detector detects alpha particles emitted from these particulates and sends electronic pulses to an amplifier, which transmits the pulses to a primary single-channel analyzer (SCA) and then to a ratemeter. The amplitudes of the pulses produced by the detector are proportional in voltage to the energies deposited in the detector by the alpha

particles. The SCA consists of upper and lower discriminators that determine pulse rejection or acceptance according to their voltages. The voltage of a given pulse must fall within the limits prescribed by the discriminator settings in order to send a pulse to the instrument's ratemeter. By this arrangement, the CAM can be adjusted to monitor only alpha particles within a particular energy range. Alpha particles with energies above or below the upper and lower discriminator set points will not be counted. Typically, at Los Alamos, CAMs are adjusted to detect alpha particles with energies between 4.65 and 5.65 MeV. This adjustment allows detection of ^{239}Pu (5.15 MeV), ^{238}Pu (5.50 MeV), and ^{241}Am (5.49 MeV), which are of primary interest.

A significant problem with CAMs is spurious alarms caused by the presence of natural background radiations from radon-thoron daughters. Radon (^{222}Rn) and thoron (^{220}Rn) emanate continually from soil and most building materials at highly variable rates that depend upon temperature, barometer pressure, and humidity. After emanating, they decay into a series of radioactive daughter products before they reach a stable nuclide. Decay schemes for these nuclides are shown below.

*Eberline Instrument Corporation, P. O. Box 2108, Santa Fe, NM 87501.

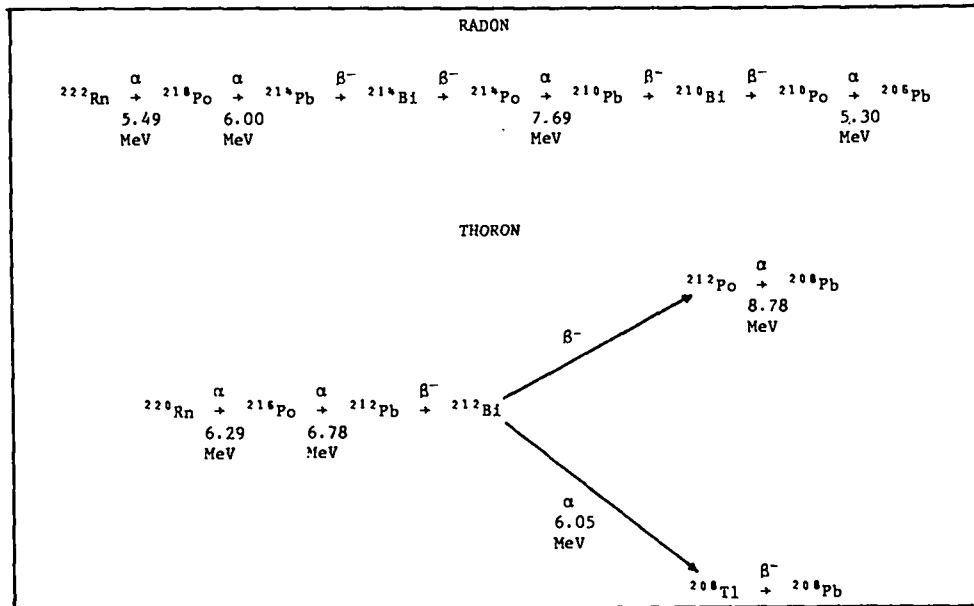

Radon and thoron decay schemes.

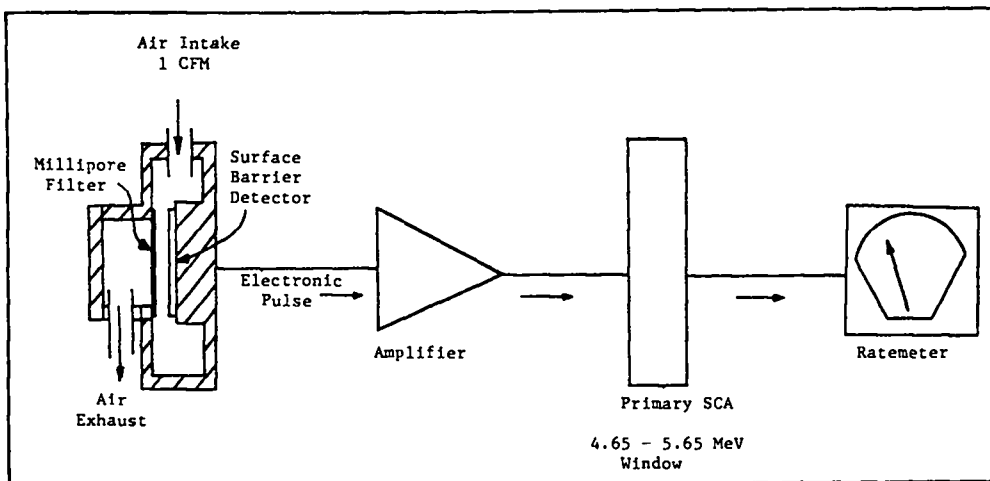

Fig. 1. Simplified CAM schematic.

Radon-220 and -222 are inert gases that pass through the filter; however, ^{218}Po (6.0 MeV) and ^{212}Bi (6.1 MeV), both particulates, are collected and may be detected in the primary SCA window because their alpha energies are degraded, as shown in Fig. 2, by the filter media and intervening air. Degradation causes pulses to fall in the 4.65- to 5.65-MeV detection window, thereby causing spurious alarms if the levels become too high.

More advanced CAMs manufactured by Eberline include a second (background) SCA and an electronic subtract circuit to cancel fluctuations in the primary

SCA window caused by these background radiations, as shown in Fig. 3. The threshold of the background SCA is determined by the upper discriminator setting of the primary SCA. The background upper discriminator is set at 6.65 MeV to give a 1-MeV window range from 5.65 to 6.65 MeV. With this setting, alpha emissions from background ^{218}Po and ^{212}Bi are observed in the background SCA and an adjustable percentage (typically about 10% as shown in Fig. 4) of their counts are subtracted from counts in the primary SCA to compensate for the ^{218}Po and ^{212}Bi emissions that overlap

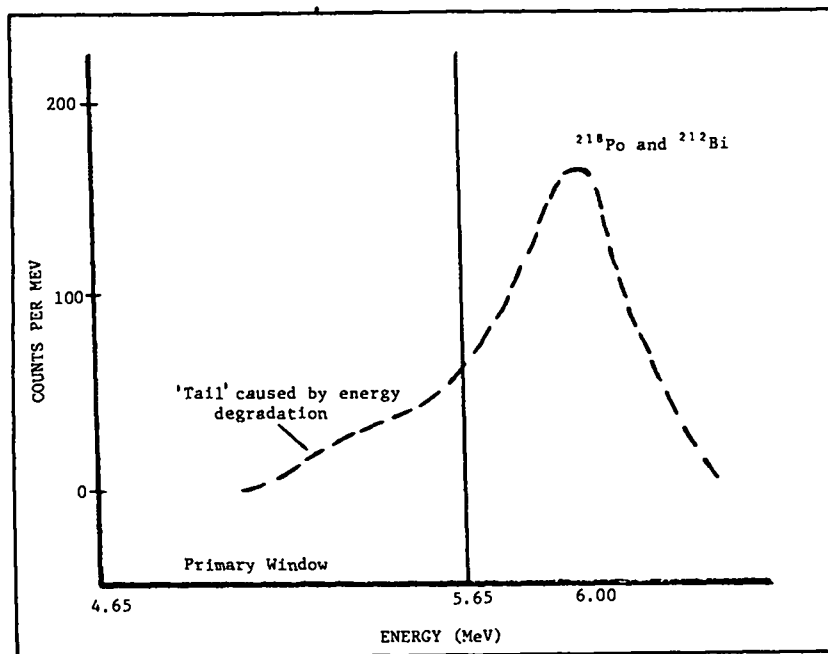

Fig. 2. Energy degradation of ^{218}Po and ^{212}Bi alpha emissions.

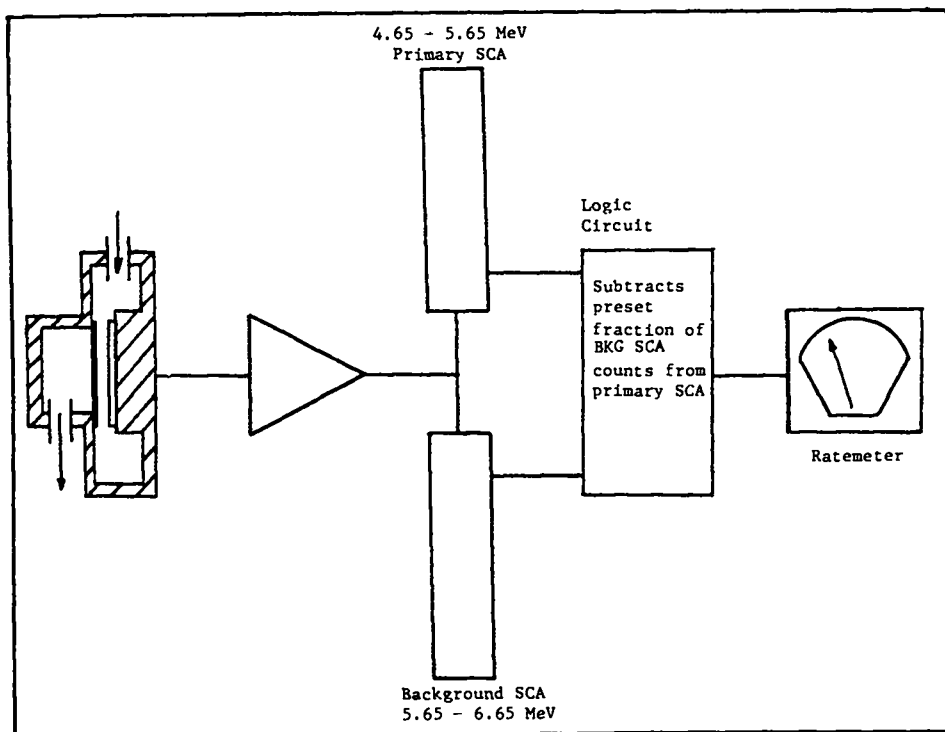

Fig. 3. CAM with background subtract.

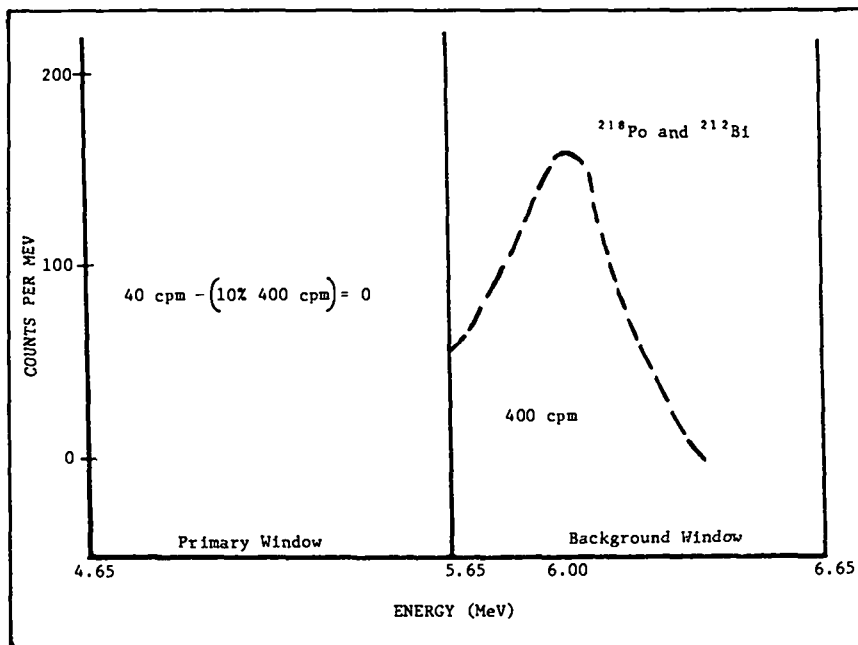

Fig. 4. Background subtraction of 10% of background window counts from primary window.

into the primary SCA. Background alpha emissions from ^{214}Po (7.69 MeV) and ^{212}Po (8.78 MeV) have energies high enough to prevent significant degradation into either the primary or the background SCAs, and therefore, are of little concern. Polonium-210 is unimportant due to the long half-life (21 years) of its grandparent, ^{210}Pb , which precludes its significant accumulation on the filter. Similarly, ^{216}Po is excluded because its half-life (0.15 second), and that of its parent, ^{220}Rn (55 seconds), are so short that they decay before appreciable filter accumulation occurs.

The manufacturer recommends an empirical adjustment of the percent background subtract in which the CAM is run for 2 to 24 hours to allow the radon-thoron daughters to equilibrate on the filter. This adjustment must be conducted in a "clean" area to assure that counts in the primary SCA are caused only by degraded background and not by plutonium or americium. After equilibrium is reached, a potentiometer is adjusted to vary the percent subtract and bring the ratemeter needle to zero. This procedure is time consuming and requires that the CAM be removed from service for adjustment.

We investigated another method whereby the alpha radiation from californium is used to simulate the 6-MeV alphas from ^{218}Po and ^{212}Bi . The filter is replaced with a californium source, which eliminates the need to establish background equilibrium or move the CAM to a "clean" area. Two californium sources were prepared and their alpha radiation spectra compared with those of the natural radon-thoron daughters. From these studies, we devised a procedure for adjusting the CAM background subtract that can be performed quickly and in the field.

II. PROCEDURE

We connected the output signal from a CAM amplifier to a Davidson Model 1056A multichannel analyzer (MCA) to study the energy spectra of radon-thoron daughters and other radionuclides of interest. This setup was capable of viewing an alpha energy range of 0 to 10 MeV with an energy resolution (FWHM) of approximately 350 keV at about 6 MeV.

Background radon-thoron daughter samples were collected by running the CAM under its usual operating conditions. Standard 5.0- μm millipore filters and a 1-CFM flow rate were used for the background collection. Background energy spectra were obtained on the MCA simultaneously with collection of the daughters on the filter, or alternately, immediately after termination of a background collection period. Also, background collection times were varied from approximately 1 hour to several days. In all cases, the background radon-thoron daughter spectra were similar in relative peak heights and energies. Figure 5 shows an example of a typical background spectrum.

Two californium sources were prepared by evaporating a standardized acidic solution onto stainless steel disks. These sources had isotopic concentrations by weight at the time of measurement of 60.05% ^{252}Cf (6.12 MeV), 20.72% ^{250}Cf (6.0 MeV), 11.52% ^{249}Cf (5.8 MeV), and 7.72% ^{251}Cf (5.7 MeV). The disks were mounted in special holders and placed in the CAMs to duplicate the geometry normally present with the millipore filters. The energy spectra of these sources were accumulated by the MCA for comparison with the ^{218}Po and ^{212}Bi background peaks.

Counting times for each source were varied to provide peaks of approximately similar heights. Polaroid photographs were taken to aid in comparison of the different energy spectra. For each case, accumulated counts in the different channels of the MCA were used to calculate the percentage of a peak falling within a given energy region of interest. Most important were calculations of the percentage of the californium and ^{218}Po - ^{212}Bi peaks that crossed over into the 4.65- and 5.65-MeV energy region, which normally is the window of the primary SCA. The percentage crossover into this region by the californium peak was compared with the similar value for ^{218}Po and ^{212}Bi to determine how closely the latter spectrum was simulated by the californium spectrum.

II. RESULTS

As shown in Fig. 6, the alpha energy spectra of the two californium sources were similar to the ^{218}Po - ^{212}Bi spectrum. However, we noted that a slight difference existed between the spectra of the two californium sources. When the low-energy edges of the two source spectra were closely compared, we observed that the

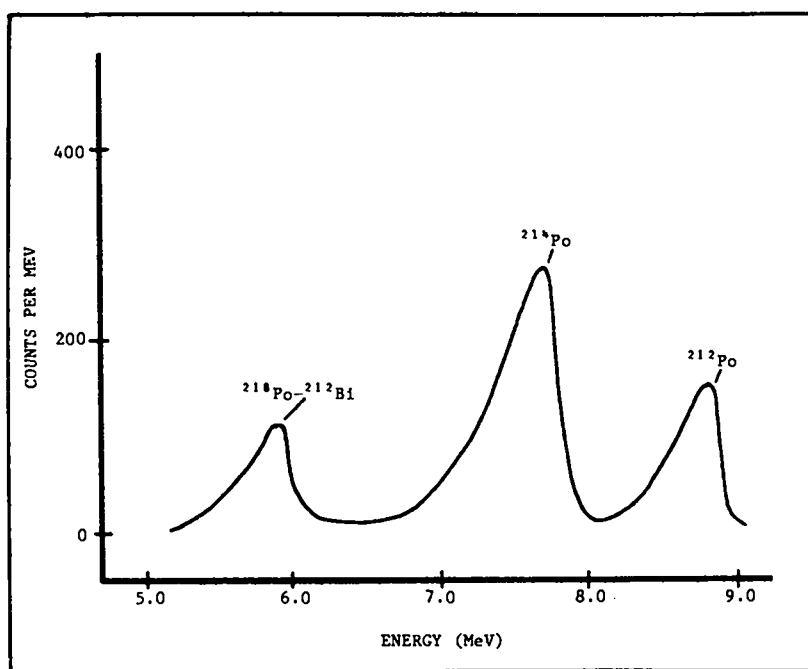

Fig. 5. Typical background alpha energy spectrum.

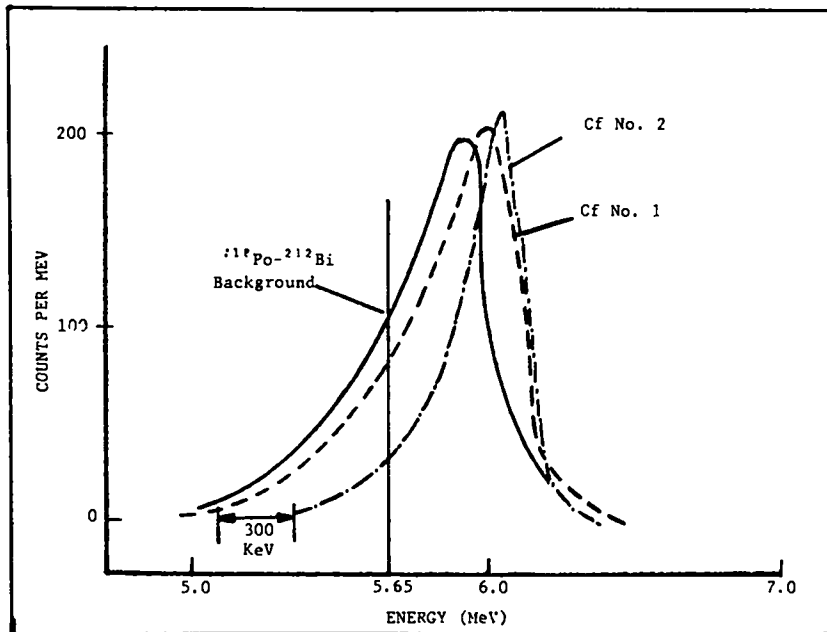

Fig. 6. Comparison of californium sources 1 and 2 with ^{218}Po background.

maximum alpha energy degradation of source 1 was about 300 keV greater than that for source 2. Because of this greater energy degradation, source 1 more closely approximated the ^{218}Po - ^{212}Bi energy spectrum than did source 2. The total ^{218}Po - ^{212}Bi counts that degraded below 5.65 MeV (overlapping into the primary SCA channel) were determined to be about 9%, while the similar values for californium sources 1 and 2 were 7% and 4%.

To set the background-subtract circuit using the californium source, the filter was removed and replaced with source 1. The percentage subtract potentiometer was then adjusted until the ratemeter fluctuations averaged near zero counts per minute.

IV. CONCLUSIONS

We concluded that the alpha energy spectrum of californium source 1 approximates the spectrum from

^{218}Po - ^{212}Bi well enough to be used to adjust the background-subtract capability of the CAMs. Californium source 2 does not simulate the background as well and is not recommended for use in background adjustment. Using source 1 instead of a background air sample obtained over several hours in a clean area allows more frequent background subtraction tests and adjustments.

Differences between the spectra of the two californium sources were caused by differences in self-absorption (source thickness) resulting from minor variations in source preparation technique. The plating of source 1 was thicker, which led to increased self-absorption and alpha energy degradation, which resulted in better approximation of the ^{218}Po - ^{212}Bi spectrum than that of californium source 2. It should be possible to alter the californium spectrum to some extent by purposely varying the source plating thickness or by changing its ratio of isotopic concentrations.

Printed in the United States of America
Available from
National Technical Information Service
US Department of Commerce
5285 Port Royal Road
Springfield, VA 22161

Microfiche (A01)

Page Range	NTIS Price Code	Page Range	NTIS Price Code	Page Range	NTIS Price Code	Page Range	NTIS Price Code
001-025	A02	151-175	A08	301-325	A14	451-475	A20
026-050	A03	176-200	A09	326-350	A15	476-500	A21
051-075	A04	201-225	A10	351-375	A16	501-525	A22
076-100	A05	226-250	A11	376-400	A17	526-550	A23
101-125	A06	251-275	A12	401-425	A18	551-575	A24
126-150	A07	276-300	A13	426-450	A19	576-600	A25
						601-up*	A99

*Contact NTIS for a price quote.

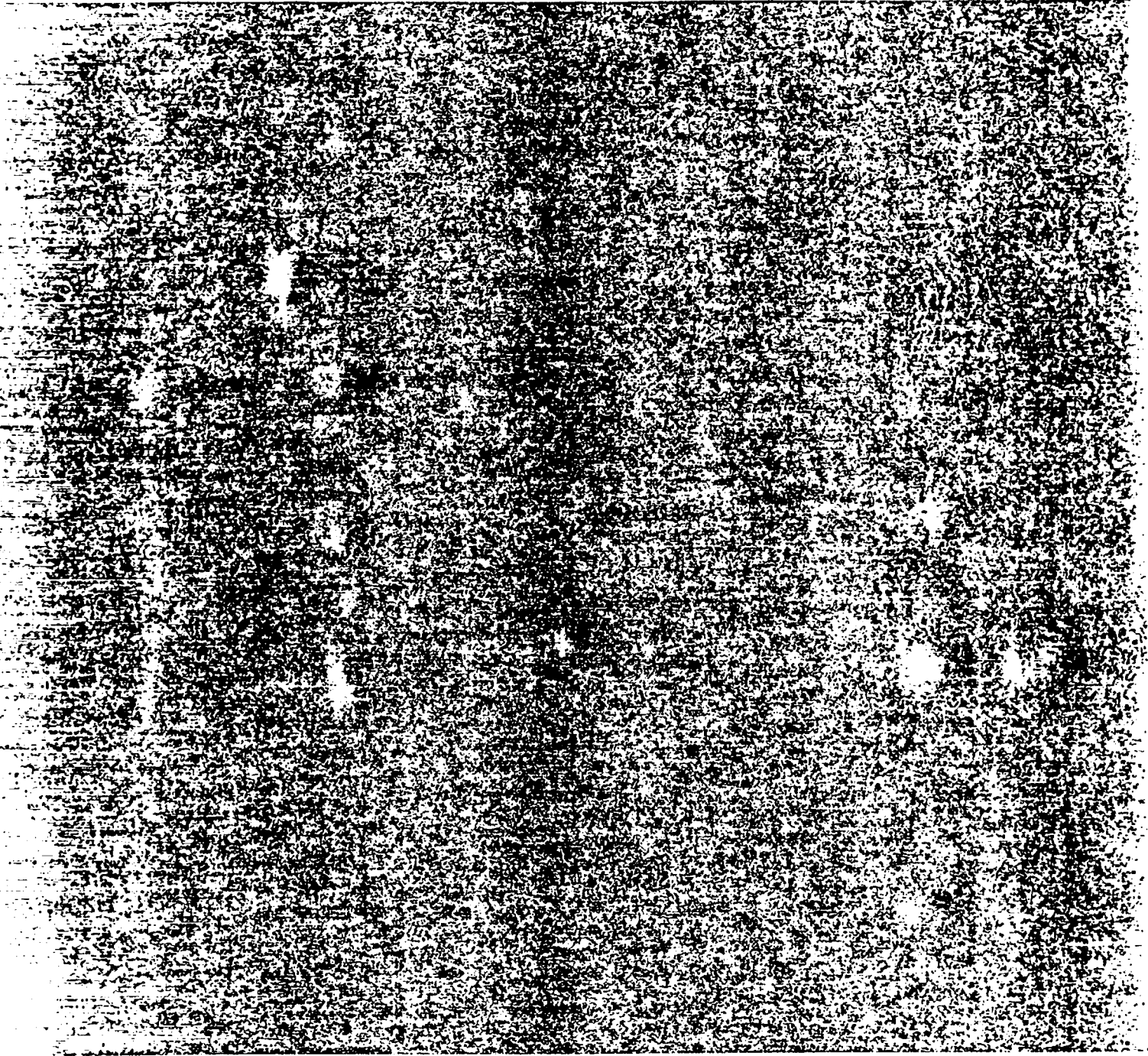

Los Alamos