

TITLE: FACILITIES FOR THE STUDY OF SHOCK-INDUCED DECOMPOSITION
OF HIGH EXPLOSIVES

AUTHOR(S): John Eric Vorthman, WX-2

MASTER

SUBMITTED TO: Proceedings of the 1981 Conference on Shock
Waves in Condensed Matter
Menlo Park, CA. June 23-25, 1981

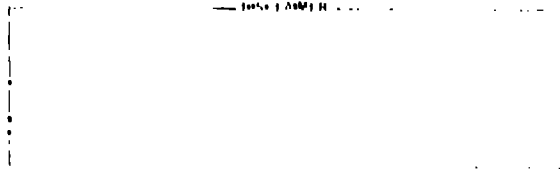

University of California

By acceptance of this article, the publisher recognizes that the
U.S. Government is, in any event, to have certain rights in order
to publish or reproduce the published form of the contribution
in whole or in part, and to allow others to do so, for U.S. Government
purposes.

The Los Alamos Scientific Laboratory reports that the pub-
lisher identifies the article as work performed under the au-
thorship of the U.S. Department of Energy.



LOS ALAMOS SCIENTIFIC LABORATORY

Post Office Box 1663 Los Alamos, New Mexico 87545

An Affirmative Action/Equal Opportunity Employer

FACILITIES FOR THE STUDY OF SHOCK-INDUCED DECOMPOSITION OF HIGH EXPLOSIVES

J. E. Vorthman

Los Alamos National Laboratory, Los Alamos, New Mexico 87545

ABSTRACT

This paper briefly describes facilities used by the Los Alamos Explosives Technology group to study the shock-induced decomposition of high explosives.

INTRODUCTION

Shock wave experiments have been done at the DF-Site of Los Alamos National Laboratory (Table 1) for almost 30 years. The primary mission of this section of the Laboratory is to gain a fundamental understanding of shocked induced decomposition of high explosives. Work done in the past has included experimental technique development, equation of state measurements, and reaction rate formulations. This paper briefly describes our facilities and research program. All references are to work that has been done here even though the methods may have been developed elsewhere.

COMPRESSED GAS GUN

Our most successful modeling of shock induced decomposition of explosives^{1,2} has been based on embedded Manganin pressure gauge data gathered using a compressed gas gun. The gun is 7.6 m long, its bore is 70 mm, and it has been used to fire projectiles at velocities in excess of 1.6 km/s (see Table 1). Recent modifications to the double-diaphragm breech are expected to increase the maximum projectile velocity by several hundred meters per second. Projectile velocity is measured using shorting pins (Fig. 1) of various heights to start and stop electronic counters (10 ns resolution).

The principal use of the gun is to produce a planar shock of known strength in a high explosive (HE). High speed oscilloscopes (Tektronix 7864) are used to measure the output signal from a Manganin pressure gauge embedded in the HE (Fig. 2). A series of these experiments is done, varying only the location of the gauge (Fig. 3). Finally, a Lagrangian analysis^{1,2} of the data is performed, an equation of state assumed, and the degree of reaction obtained (Fig. 4).

Other instruments used at the gun facility include quartz gauges, electromagnetic stress and particle velocity gauges, a rotating mirror streak camera, and image intensifier cameras. A technique is being developed to combine electromagnetic stress and particle velocity gauges (Fig. 5).

TABLE I
SHOCK WAVE FACILITY

Laboratory Facilities

70-mm-bore single stage compressed gas gun (0.05 to > 1.6 km/s)
2 sites for firing high explosives
Electrically-driven flyer facility (56 μ F, 20 kV)

Instruments

Tektronix 7844 Oscilloscopes
(1) Manganin pressure gauges
(2) Combined electromagnetic stress and particle velocity gauging
(3) Quartz gauges
Rotating Mirror Cameras
Writing speed \leq 16 mm/ μ s
Gear Electronic Streak Camera
Writing speed \leq 5 nm/ns
Image Intensifier Cameras
10 ns resolution, intensification gain \leq 10,000

Principal Investigators

Jerry Wackerle, Section Leader (HE, Gas Gun, Theory)
Allan Anderson (Theory)
Mike Ginsberg (Gas Gun, HE)
Ron Rabie (Propellants, Theory)
Wendell Seitz (HE, Electric Flyers)
Garry Schott (HE, Gas Gun, Theory)
Robert Spaulding (HE)
John Vorthman (Gas Gun, Theory)

Recent Studies

A Shock Initiation Study of PBX 9404
Shock Initiation of Porous TATB
Pulsed Laser Stereo Photography of Electrically Exploded Bridges
Precursors in Detonations in Porous Explosives
The Polymorphic Detonation
Three Dimensional Shock Change Relations for Reactive Fluids
An Empirical Model to Compute the Velocity Histories of Flyers
Driven by Electrically Exploding Foils

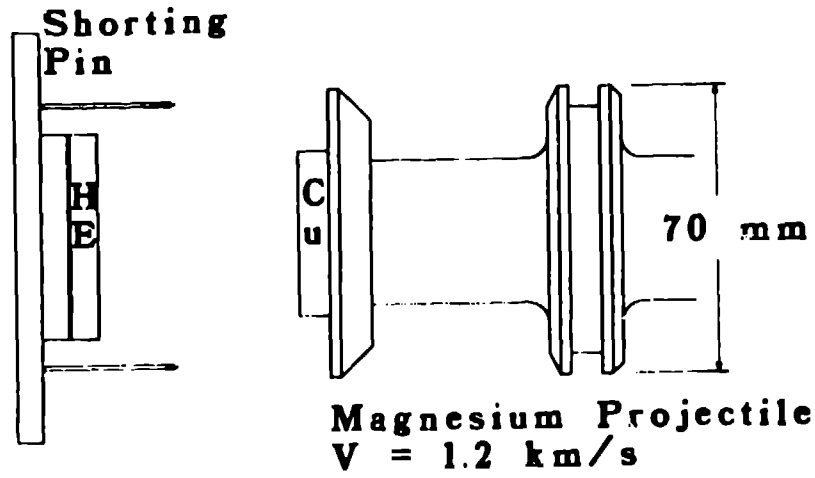

Fig. 1. Typical gun experiment.

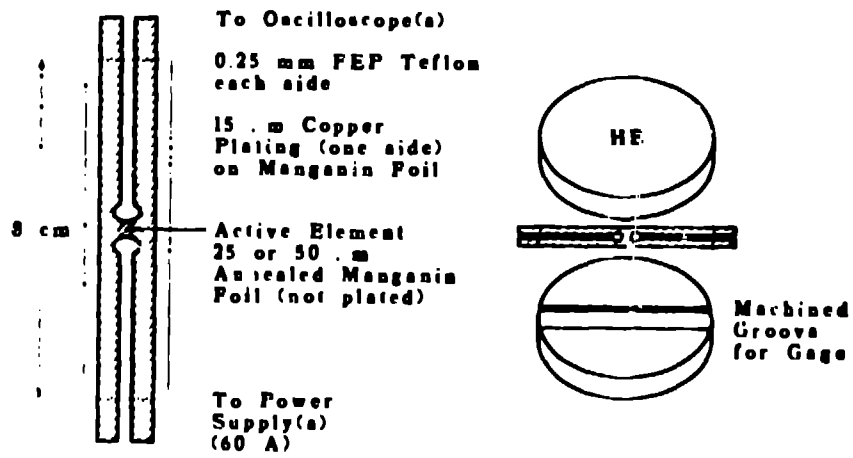

Fig. 2. Manganin gauge.

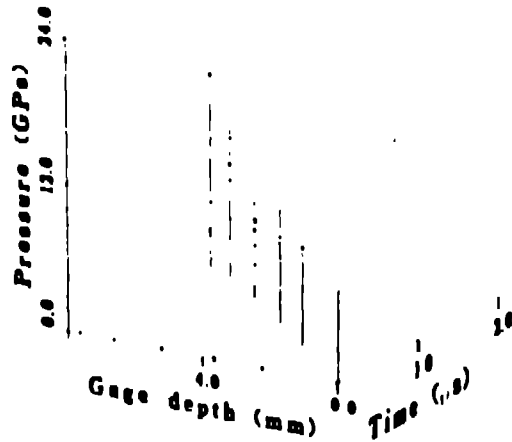

Fig. 3. Manganin-gauge data.

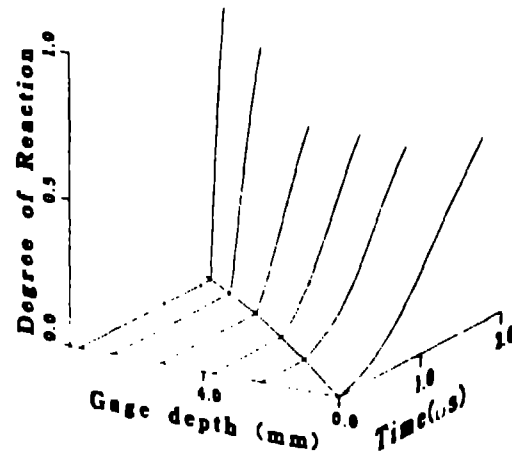

Fig. 4. Analyzed data.

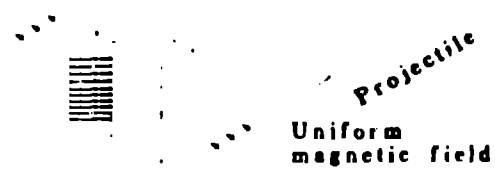
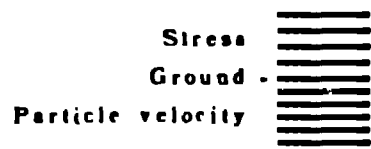

Fig. 5. Combined E-M gauges.

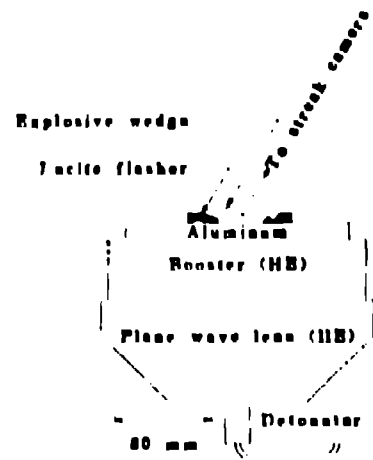

Fig. 6. Typical HE experiment.

TABLE II

Compressed Gas Gun

Recoiling barrel	
Bore	70 mm
Length	7.6 meters
Wraparound breech	
Volume	23 liters
Maximum gas pressure	43 MPa (6250 psi)
Double-diaphragm breech	
Volume	28 liters
Maximum gas pressure	103 MPa (15,000 psi)

EXPLOSIVELY PRODUCED SHOCKS

One datum that is used to characterize each HE is the distance a shock must travel before the onset of detonation for a given input shock strength. This datum is usually collected using another HE to generate the input shock (Fig. 6). The HE of interest is wedge-shaped and a rotating mirror camera is used to record the position of the shock wave as it breaks out of the sloping wedge face. Detonation is characterized by a (usually) sharp change in the shock velocity. Reference 3 is another example of research being done that uses one HE to study another.

ELECTRICALLY-DRIVEN FLYER FACILITY

Our electrically-driven flyer facility is capable of accelerating a one-half-inch-square Mylar flyer to 3.2 km/s. Energy is stored in capacitors (56 μ F at 20 kV total). Instruments used in conjunction with this facility include a pulsed ruby laser for stereo photography⁴ and an electronic streak camera. A Fabry-Perot interferometer is being assembled for use with all the facilities described above.

REFERENCES

1. Jerry Wackerle, R. L. Rabie, M. J. Ginsberg, and A. B. Anderson, Proceedings of the Symposium on High Dynamic Pressures, Paris, France, p. 127, 1978.
2. Allan B. Anderson, M. J. Ginsberg, W. L. Seitz, and Jerry Wackerle, Seventh Symposium on Detonation, Office of Naval Research (to be published) (1981).
3. R. L. Spaulding, Jr., Seventh Symposium on Detonation, Office of Naval Research (to be published) (1981).
4. W. L. Seitz and S. D. Gardner, SPIE 94, 100 (1976).