

**Edited by Paul W. Henriksen, Group IS-11**  
**Prepared by Paul W. Henriksen, Group IS-11**

***An Affirmative Action/Equal Opportunity Employer***

*This report was prepared as an account of work sponsored by an agency of the United States Government. Neither the United States Government nor any agency thereof, nor any of their employees, makes any warranty, express or implied, or assumes any legal liability or responsibility for the accuracy, completeness, or usefulness of any information, apparatus, product, or process disclosed, or represents that its use would not infringe privately owned rights. Reference herein to any specific commercial product, process, or service by trade name, trademark, manufacturer, or otherwise, does not necessarily constitute or imply its endorsement, recommendation, or favoring by the United States Government or any agency thereof. The views and opinions of authors expressed herein do not necessarily state or reflect those of the United States Government or any agency thereof.*

**THIEF**

*Version 1.0*

*An Interactive Simulation of  
Nuclear Materials Safeguards and Security*

*W. D. Stanbro*

*P. W. Henriksen*



**MASTER**

# CONTENTS

<b>I. INTRODUCTION</b> .....	<b>1</b>
<b>A. Overview</b> .....	<b>1</b>
<b>B. Setting and Assumptions</b> .....	<b>2</b>
<b>1. Threat</b> .....	<b>2</b>
<b>2. Facilities Description</b> .....	<b>2</b>
<b>II. SYSTEM REQUIREMENTS AND INSTALLATION</b> .....	<b>2</b>
<b>A. System Requirements</b> .....	<b>2</b>
<b>B. Installation</b> .....	<b>2</b>
<b>1. Installation on a Hard Disk</b> . . . . .	<b>2</b>
<b>2. Installation on a Floppy Disk</b> . . . . .	<b>3</b>
<b>3. Files Supplied with THIEF</b> .....	<b>3</b>
<b>III. STARTING THIEF</b> .....	<b>3</b>
<b>IV. RUNNING THIEF</b> .....	<b>4</b>
<b>A. Options</b> .....	<b>4</b>
<b>B. Playing the Game</b> .....	<b>6</b>
<b>V. ADDING OR CHANGING SCENARIOS</b> .....	<b>8</b>
<b>VI. ARCHIVING DATA FILES</b> .....	<b>13</b>
<b>A. Input Data Files</b> .....	<b>13</b>
<b>B. Output Data Files</b> .....	<b>13</b>
<b>VII. OUTPUT FILE FORMAT</b> .....	<b>14</b>

1

**THIEF**  
**Version 1.0**  
**AN INTERACTIVE SIMULATION OF**  
**NUCLEAR MATERIALS SAFEGUARDS AND SECURITY**

by  
W. D. Stanbro and P. W. Henriksen

**ABSTRACT**

This is a users manual for the prototype of **THIEF**: an interactive simulation of safeguards and security at a nuclear facility. The program puts the user in the position of an insider trying to steal special nuclear material from a facility. The program runs on IBM PC compatible microcomputers with a minimum of 640K of RAM, an EGA or VGA graphics card, and preferably a color monitor.

---

## **I. INTRODUCTION**

### **A. Overview**

**THIEF** is an interactive game that simulates the relationships between physical protection and materials control and accountability (MC&A) elements. **THIEF** does this by placing the player in the role of the insider trying to steal special nuclear materials (SNM) from a facility. The user may also take on the role of a facility designer setting up a model facility to mirror an existing or planned nuclear processing plant. The computer plays the facility. The physical layout of the plant, process details, physical protection precautions, and MC&A elements may all be modified within certain constraints. The nature of the insider can be modified by controlling his access to information about the plant and the flow of nuclear materials and even the thief's physical access to various parts of the plant at various times of the day.

The program employs a "user friendly" graphical interface to allow people with limited computer experience to use the simulation with ease. The program is implemented in Turbo C for IBM PC compatible computers with 640K of RAM and EGA or VGA graphics and, if available, a color monitor.

## B. Setting and Assumptions

1. *Threat.* In THIEF the threat is a plant employee who desires to remove significant amounts of nuclear material from the plant. To do this, the thief will not resort to violence, but will use any other avenue to steal SNM. The thief has access to at least some areas of the plant where nuclear materials are processed and also may have access to information about the plant's materials accounting system. The thief's physical and information access can be varied to simulate different groups of employees. For example, the thief may be allowed access to specific buildings in the plant or to any building in the plant; the thief's knowledge of materials accounting reports, published each accounting period, and the cumulative data on the accounting system's performance may also be restricted. Limiting access increases the probability of detection if the thief carries on any action in a restricted building. The hours the thief can be in the plant can also be limited. Actions outside of normal working hours also increase the probability of detection.

2. *Facilities Description.* The plant facility is described in THIEF on three different levels. The highest level describes the plant's arrangement of fenced enclosures and buildings. The thief's movements are tracked in terms of his position with regard to these enclosures or buildings. The model is presently limited to one enclosure and two buildings.

The second level indicates the processes in each building. The processes are designated by symbols that indicate the pipes, reactors, mixers, separators, etc. For a complete list of the possible parts of the plant see Section V. The parts are numbered for convenient reference.

The final level of detail describes the attributes of the user-defined points throughout the facility. A thief acts with reference to these points. The points are uniquely numbered and include the physical barriers in the facility and the parts of the plant through which the SNM flows. For example each portion of the fence has a number; if the thief wants to throw some SNM over the fence, the user must specify the part of the fence over which it will be thrown. Other numbered points include the location in a process stream where material enters a materials balance area (MBA) and the portals through the enclosures and buildings. Such points might have instruments to measure concentration and flow for accounting purposes, or a detector to indicate the presence of radioactive material or unusual amounts of metal. A map of the enclosure and buildings with the parts numbered is included in Section IV.

## II. SYSTEM REQUIREMENTS AND INSTALLATION

### A. System Requirements

THIEF runs on IBM PC compatible computers with at least 640 Kbytes of memory. An EGA or VGA graphics card is also required. The program runs under PC-DOS or MS-DOS version 2.0 or later. A math coprocessor chip is not required, but will be used if it is available. THIEF is best run from a hard disk. However, it can be run from a high density 5 1/4 in. floppy disk or either a high- or low-density 3 1/2 in. floppy disk.

### B. Installation

1. *Installation on a Hard Disk.* Create a directory on your hard disk to hold the THIEF program and its data files. Next copy all of the files from the distribution disk into this directory. THIEF will always look in the current default directory for its input files. It will also save its output files to this directory. You are now ready to run THIEF.

**2. Installation on a Floppy Disk.** Copy all of the files on the distribution disk to the floppy disk. THIEF assumes that the floppy disk with the program and the data will be in the computer's default drive. The floppy disk must be a high-density 5 1/4 in. disk, a low-density 3 1/2 in. disk, or a high-density 3 1/2 in. disk.

**3. Files Supplied with THIEF.** Two types of files are supplied on the THIEF distribution disk. Files with the extension .EXE contain the executable code. Files with the extension .DAT contain the input data for a sample scenario. When it is run, THIEF produces a third file type with the extension .PRN. This file, an ASCII text file that is Lotus 1-2-3 compatible, contains the output data. THIEF expects all of these files to be in the default drive and directory when it runs.

### III. STARTING THIEF

To start THIEF, first make the drive and directory containing the THIEF files the default drive and directory by typing `cd \thief <ret>`. Next type `thief <ret>`. You will see a title screen. Follow the directions on the screen until you get to the Main Menu, as shown below.

#### THIEF

I)input or edit a scenario (Archive old scenarios first)  
 A)rchive or retrieve an old scenario  
 R)un THIEF (Archive output first)  
 archive O)utput  
 Q)uit

Choice: \_\_\_\_

Option I, described in Section V, allows you to create your own THIEF scenario by editing the supplied scenario or entering a completely new facility description. This choice will change the present scenario, so first archive it (choice A) if you wish to save it. Saving the standard scenario is highly recommended the first time you attempt to change it because it is complete and will be useful for reference later. This archiving scenarios option is explained further in Section VI.

The R option runs the THIEF program. This is explained in Section IV. Running THIEF will destroy the existing output file, which contains the results from the previous playing of the game. Use choice O, described in Section VI, to save an existing output file for later evaluation.

The final choice, Q, exits THIEF.

**Practical Note:** Type the single letter preceding the closing parenthesis to access that option. Subsequent menu choices are activated in the same way.

## IV. RUNNING THIEF

### A. Options

By selecting the **R** option from the main menu, the user will see the main **THIEF** screen as follows. If the scenario is changed, the main **THIEF** screen will change to reflect the new scenario.

**THIEF**

<b>S)art</b> <b>P)ause/restart</b> <b>C)ommand action</b> <b>E)rase window</b> <b>Q)uit</b>	<b>M)aps</b> <b>D)escription</b> <b>clock R)ate</b> <b>T)hief profile</b> <b>F)acility status</b>	<b>Day:</b> <b>Hour:</b>
---	---	-----------------------------

**Thief's location: Enclosure- Building-**

<b>Cached in Building 1:</b>	<b>Cached in Enclosure 1:</b>
<b>Cached in Building 2:</b>	

**Carried by Thief:                      SNM-Shielding-**

**Total Stolen:**

**Diverted this period from MBA 1:**

**Diverted this period from MBA 2:**

This screen lists the available options and keeps score for the game by reporting the game time and the amount of SNM diverted, stolen, cached in various locations, or held by the thief. The area just below the day and hour displays messages such as the arrival and departure of vehicles or if the game has been "paused." The display also shows the current position of the thief. All other information displayed during the game is shown on a series of windows that "pop up" against this background.

Before starting the game the user should look through the various options to gain a feel for the nature of the scenario. The thief may take no actions until the game starts. Starting the game displays a window giving the MC&A information for the most recent accounting period if the thief has access to this information. A similar window will be displayed the day after each accounting period ends. The player will also be informed when a vehicle enters or leaves the facility.

The functions of the various options on the main menu are shown in Table I. Amplification of the more complicated options is provided below.

**Table I. Main Screen Options**

<b>Option</b>	<b>Description</b>
<b>S)tart</b>	Starts a game
<b>P)ause/restart</b>	Toggles between pausing and running game
<b>C)ommand</b>	Commands the thief to perform an action
<b>E)rase</b>	Erases topmost window from the screen
<b>Q)uit</b>	Quits game, but asks for confirmation
<b>M)aps</b>	Displays maps of Enclosure 1 and Buildings 1 and 2
<b>D)escription</b>	Describes points, instruments, detectors, and map symbols
<b>clock R)ate</b>	Allows choice of game clock rate
<b>T)hief profile</b>	Displays thief time, building, and information access
<b>F)acility Status</b>	Displays facility inventory difference and schedules for facility vehicle traffic

The **C)ommand** option directs the action of the thief at the command of the user by displaying a menu showing the options and the two letter code to activate the option. Table II lists the available actions and the codes to access them.

**Table II. Thief Codes and Actions**

<b>Code</b>	<b>Action</b>
<b>MO</b>	Move through Portal
<b>LO</b>	Load SNM or Shielding
<b>UN</b>	Unload SNM or Shielding
<b>BR</b>	Breach a Barrier
<b>TH</b>	Throw SNM over a Fence
<b>UT</b>	Use Utility Line (as conduit for removing SNM)
<b>VE</b>	Load SNM on a Vehicle



The **D**escription option provides detailed information about the points, instruments, detectors, and map symbols used in the game. Points and map symbols are defined by number, while instruments and detectors are defined by name. Lists of these names and numbers are included in Section V. After specifying the desired number or name, the program will show a screen with all pertinent information about that location or machine, such as the inflow and outflow of SNM, or the safeguards at that spot.

At any of the prompts deriving from the command menu the user may enter **M**, **D**, **T**, or **F** to access the Map, Description, Thief Profile, or Facility Status options from the main menu. These options open a second window on the screen. Maps for the enclosure and the buildings may be viewed with the **M** option, but the building and enclosure maps for the example scenario are included in this manual for handy reference. All actions in the game are taken with reference to a specific point in the facility, for example point 22, the portal into the enclosure. See figures 1, 2, and 3 below.

The clock **R**ate option allows you to specify how fast time passes in the game. You might want to set the clock to run quickly at night and on weekends if the thief is only allowed to be in the facility during normal working hours during the week. At other times you might want the clock to run slowly.

## B. Playing the Game

The goal of the game is to steal enough SNM from the facility to create an improvised nuclear device (bomb). For the game this amount is set at 5 kg. The simulation starts with the thief outside the facility (enclosure 0 and building 0). The first action that the user can take upon starting the game is to move into the enclosure, but not into one of the buildings. The first command screen requires the user to answer enclosure 1, building 0, and portal 22, if the example scenario is used. The next action is up to the user, both buildings may be entered, or the thief may try to breach the walls, although that is heavy-handed. After that the thief can move in and out of the buildings and pick up and move shielding or SNM. Keep the maps, Figure 1, 2, and 3, handy because all actions are made with reference to them. Changing scenarios will change the available options. The thief's primary actions are to divert various amounts of SNM from the process lines and get it out of the facility. To do so requires cunning. Taking too much at once makes it likely that the portal monitors will catch the thief. Taking too little makes it probable that the repeated actions will become obvious to someone else in the plant and the thief will be caught. Deciding how much to take is up to the thief.

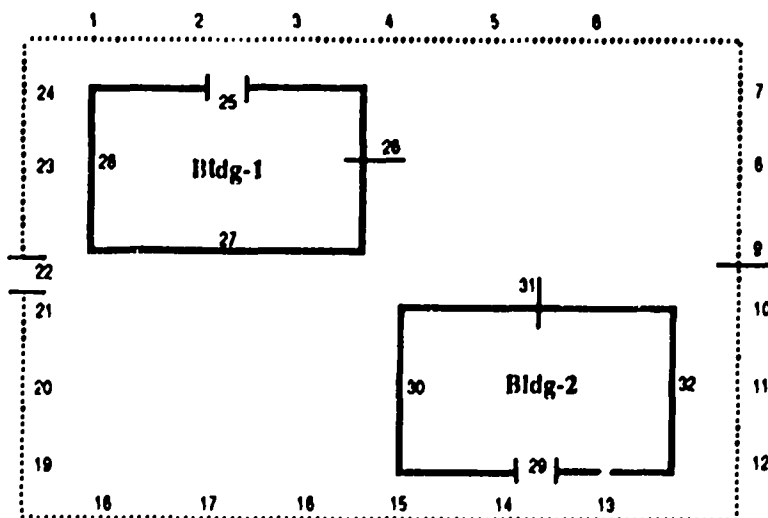

Figure 1. Enclosure and building map for the example scenario.

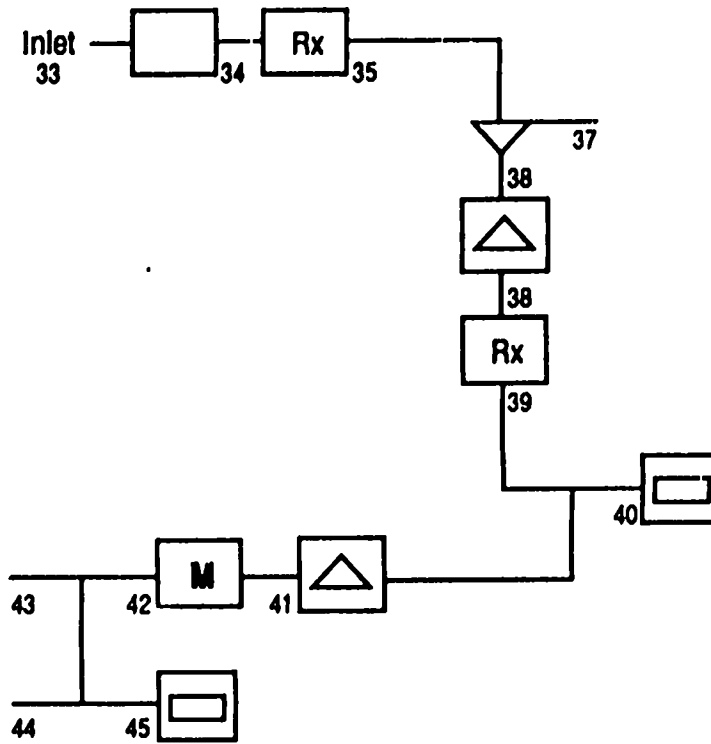

Figure 2. Process map for building 1 in the example scenario.

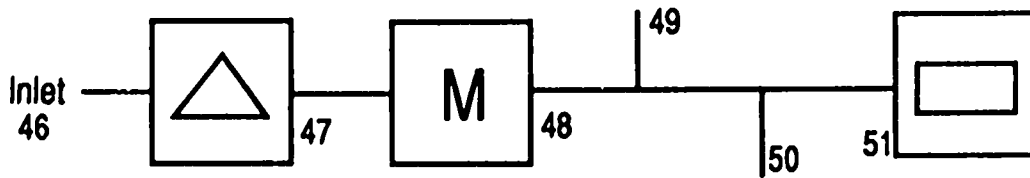

Figure 3. Process map for building 2 in the example scenario.

## V. ADDING OR CHANGING SCENARIOS

An example scenario is provided with the game. Creating an entirely new scenario or changing the provided scenario is optional. (Option I under the Thief Main Menu.)

Perhaps the most difficult task associated with THIEF is creating a new scenario because a large amount of information is necessary to define a scenario and some degree of abstraction is necessary to put real facility information into the program. The scenario input module facilitates this process by prompting the user in a logical way for the required information. The following screen is displayed when the input option is selected.

### THIEF SCENARIO GENERATOR

**D)efine scenario**

**U)iew scenario**

**Q)uit**

Option **D** allows the user to define a new scenario or edit an existing scenario. Both options follow the same basic format. The user is presented with a series of items for which the characteristics can be changed or left at the default value, which is in parentheses.

Option **U** allows the user to view the portions of the current scenario. Any changes made during a session will be saved to the current input data files. Therefore, it is important to archive files as described in Section VI to prevent their destruction.

Option **Q** quits to the main menu.

In the **D)efine scenario** option it is logical to first enter the characteristics of the detectors and instruments, followed by the enclosure structure with its point labels, and then the process details with their point labels. An instrument must be defined before it is installed in the facility; following the screens in order will accomplish this automatically. Once the point labels have been defined, the characteristics of each point can be entered. This can be followed by the safeguard system features, the vehicle schedules, and the thief access characteristics. Instruments are characterized in terms of their random and systematic or bias errors. Detectors are given a minimum and maximum probability of detection along with a sensitivity. The sensitivity limit corresponds to the amount of material that will give the maximum detection probability. The response between zero material and the amount equal to the sensitivity is assumed to be linear. In general, as the user is queried for information, the current value is shown, usually in parentheses. Pressing a return will reenter the default numerical value, but text strings, such as building labels, must be reentered and followed by a return to prevent total chaos.

**Practical note:** At some places in this option typing **q** will allow you to quit that option. Be sure not to type in **q** at any option in which a text string is the desired response. Typing **q** will substitute **q** for the name of the instrument. Once the name of the instrument is entered, THIEF will prompt for the systematic error and random error. Enter a number if you want to change the default.

You will encounter the following items if you choose the complete scenario option.

**Instruments.** First define the number of instruments in the facility, then define each type of instrument. Ten different types may be specified (six are included in the example), and

you can specify other kinds of instruments, or specify more than one of any kind, and change the characteristics to make the instruments different. The null instrument is number 1. This could be used if you want no instrument at a certain place in the facility, however instruments can be inserted at any time. A chemistry instrument (any chemical analysis instrument) is number 2. An nda (nondestructive assay) instrument is number 3. The fourth is an ms (mass spectroscopy) instrument. The fifth instrument is labelled count for item counter. It counts the number of items passing through the facility. The sixth type of instrument is labelled flow for flow rate meter.

**Detectors.** This portion of the program allows you to specify the types of detectors allowed in the facility. Five detectors are available in the game, for the following quantities: radiation, metal, eyeball (a human detector), breach, and motion. In each case the game will ask for the sensitivity, the minimum detection probability, and the maximum detection probability (numbers between 0 and 1) for each detector.

**Facility.** This section lets you specify the number of buildings and their location on the board used in the game. Choose the number of buildings, 1 or 2, and the location. The location is specified by the row and column numbers, 0 to 7, as shown in Figure 4. The coordinates designate the center of the building. The option then asks for further information on the facility, i.e. the walls, fences, and plant processes. To fill in the physical map, you must decide on the row number and column number from Figure 4, and the symbol number from Figure 5 and the point number for the item. You decide the point number. In the plant processes section, you will fill in information on the Process Map through the row, column, and symbol numbers, and the point numbers. These questions are repeated for building 2 if it is in the facility.

	0	1	2	3	4	5	6	7
0								
1								
2								
3								
4								
5								
6								
7								

Figure 4. Sample grid for placing buildings and barriers on the playing screen.











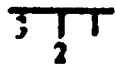















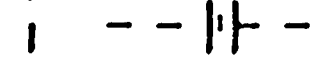
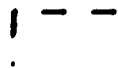
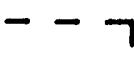







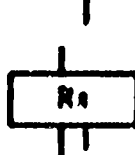



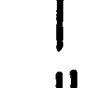

Number	ID	Symbol
0	Blank	
1	Inlet	Inlet 1
2	Tank	
3	Tee	
4	Pipe	
5	Pipe	
6	L. joint	
7	L. joint	
8	Wall	
9	Wall	
10	Door	
11	Door	
12	Wall corner	
13	Wall corner	
14	Wall corner	
15	Wall corner	
16	Fence	
17	Fence	

Figure 5. The symbol designations shown here and on the facing page should be used when describing portions of the facility for a new scenario.

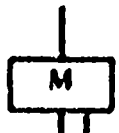
18	Gate		
19	Gate		
20	Fence corner		
21	Fence corner		
22	Fence corner		
23	Fence corner		
24	L		
25	L		
26	Tee		
27	Blender		
28	Separator		
29	Reactor		
30	Reactor		
31	Tank		
32	Furnace		
33	Furnace		
34	Vault		
35	Vault		
36	Machine		
37	Machine		
38	Utility Lines		
39	Utility Lines		
40	Utility Lines		
41	Utility Lines		

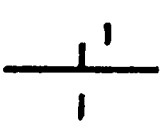
**Point Data.** The game will prompt you for the point number or a Q to quit. To specify a point on the game board, type in the number of the point, such as 1. These points will have already been defined by you in previous steps discussed above. The game is now looking for data concerning the points. It first asks for building designation (0 for no building, 1, or 2). Then it asks for flow rate in kg/day, concentration in kg/kg, inventory in kg, and the fraction of inventory change (a number between 0 and 1).

**Safeguards.** The game will ask first for the number of accounting periods (the more accounting periods, the more difficult it will be to sneak out a large amount of SNM), then whether or not the two man rule is in effect (this means that someone besides the thief will be in all areas of the plant at all times), and then for the number of MBA's. Then it asks for the point to safeguard or Q to quit. Here you must specify one of the numbered points previously defined in the scenario. You will first be prompted for the MBA for that point (specify 0 if the point is not to be in an MBA. The next piece of information is the point type, choose from I)input, O)output, IN)ventory point, or none of the A)bove. Input, output, and inventory point choices all bring up the same series of screens. First you are asked for the volume or mass flow. Type in the number you have chosen for that point, but do not specify the units. Units of kg/day or liters/day are implied for the two flows. Concentration comes next. Here the program is looking for a number in kg/l or kg/kg. Be consistent with the volume or mass flow. Inventory measurement comes next. Specify the name of the instrument to make the measurement, such as a counter or a mass spectrometer. Finally specify the number of measurements per accounting period. Then it will prompt you for the kinds of detectors to be used to safeguard the point. Answer yes or no to each of the prompts.

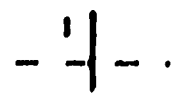
**Vehicles.** Here you may specify the hours of the day at which they enter and leave the facility (in military time).

**Thief profile.** This section lets you specify the information to which the thief will be given access.

The final specifications are for the starting and ending times of the game.

The **View scenario** option operates in much the same way as the information screens in the game. The Map, Descriptions, and Thief options are also available in the scenario input part of the module when the user is presented with the underscore prompt. To access these options enter an M, D, or T. The enclosure and building maps are the same as in the game section. The thief option gives one screen of data on the thief's access possibilities. The vehicles option gives the schedules for the vehicles.

The safeguards option specifies the MC&A system: the number of MBA's, the accounting period, and if the two man rule is in effect. The second screen lists the input, output, and inventory points for the first MBA and the third screen lists the same information for the second MBA. More screens follow if more MBA's are specified.

The Descriptions section contains the most information. It discusses points, instruments, detectors, and symbols; lists the instruments and detectors; and gives the map and grid numbers for the playing field. Under point description, type in the number of the point and the game will display the flow rate, the concentration, the inventory, the instruments at that point, and the detectors at that point. Under instruments, it will ask you to specify an instrument. Enter the name of the instrument from the previously discussed list: chemistry, nda, ms, count, or flow. The program will display the systematic and the random error associated with each instrument. Under detectors, it will display the sensitivity of the detector and tell you the minimum and maximum probabilities of detection for each one. Five types of detectors are discussed: radiation, metal, eyeball, breach, and motion. Under symbols, it will display each of the 41 symbols used in the game, identify each symbol, and display the symbol itself. A complete list was provided in Figure 5 on pp. 10-11. Under the list of instruments and detectors, it simply prints a list of all the instruments and detectors used in the

game. The Map grid numbers give the coordinates of each point on the game board. The numbers are used to place items on the screen when defining the buildings. The same numbers are used to place the processes in the buildings.

## VI. ARCHIVING DATA FILES

### A. Input Data Files

Choosing option **A)** for archive under the main **THIEF** menu lets you put aside any scenario or run file for later use. You should always use this option before identifying a new scenario, just in case you want to use the previous scenario again. **THIEF** expects input data files to have a standard name with the extension **.DAT**. To save input data files the **A)** option in the main menu allows the user to change the extension from **.DAT** to some other sequence. The **A)** option also allows old scenario input files to be made the current input files by being changed to **.DAT** again.

You might also want to archive output files to save the results of playing the game. This is option **O)** under the main menu. See part **B)** below.

Choosing the **A)** option gives you the following screen.

#### Thief Archive Utility

**A) Archive run files**

**C) Convert archived files to run files**

**O) Quit**

Choice: \_ \_ \_ \_ \_

Choice **A)** asks you for the archive filename extension for the file to be saved. Type in a three letter file name extension and it will convert the **.DAT** filename extension to the new one. Giving it more than a three letter name will result in the first three letters being used for the extension. The program will save the file and send you back to the Thief Archive Utility screen. To get an archived file back, use the **C)** option, and reenter the extension at the prompt.

### B. Output Data Files

The output data file is named **TSAVE.PRN**. To avoid writing over this file when a new **THIEF** run is made, the file must be renamed. The new file will retain the **.PRN** extension so it is still Lotus 1-2-3 compatible. To archive an output file select **O)** from the main menu. You will be asked for the new file name without the extension. Give it any name you wish up to eight letters. As usual the DOS rules apply to the characters you may use in specifying the file name. You will then be sent back to the Thief main menu.



## VII. OUTPUT FILE FORMAT

THIEF's output file contains information useful for documenting and reconstructing a run of the program. This information is stored as an ASCII text file that is capable of being read by Lotus 1-2-3. The information is arranged as a matrix with the rows corresponding to different events and the columns containing the information shown in Table III.

**Table III. Column Identification in Output File**

Column Number	Explanation
1	Day
2	Hour
3	Minute
4	Action Code (see below)
5	Enclosure where thief is located
6	Building where thief is located
7	Amount of SNM (kg) held by thief
8	Amount of SNM (kg) diverted but not removed from site
9	Amount of SNM (kg) stolen (removed from site)

The Action Code indicates that an action has been successfully completed by the thief or gives the reason for a game's termination. The meanings of the Action Codes are shown in Table IV.

**Table IV. Action Code Meanings**

<b>Action Code</b>	<b>Meaning</b>
0	Thief moves through portal.
1	Thief loads SNM or shielding from cache or point.
2	Thief unloads SNM or shielding to cache or point.
3	Thief breaches barrier to remove SNM.
4	Thief throws SNM over fence.
5	Thief uses utility line to remove SNM.
6	Thief loads SNM on to a vehicle.
1000	Thief detected crossing portal with SNM.
1001	Thief detected loading SNM from a point.
1002	Thief detected unloading SNM to a point.
1003	Thief detected breaching a barrier to remove SNM.
1004	Thief detected throwing SNM over a fence.
1005	Thief detected using a utility line to remove SNM.
1006	SNM detected on a vehicle moving through a portal.
1100	Thief victory. Greater than 5 kg of SNM diverted.
1200	Inventory difference detected above alarm level.
1250	Inventory difference trend detected is above alarm level (0.5% false alarm rate).
2000	User terminated game.