

RECEIVED
APR 11 6 1998
OSTI

*Design-only Conceptual Design
Report for Pit Disassembly and
Conversion Facility*

*Project No. 99-D-141 for the Department of Energy
Office of Fissile Materials Disposition (DOE-
OFMD)*

DISTRIBUTION OF THIS DOCUMENT IS UNLIMITED

MASTER

Los Alamos
NATIONAL LABORATORY

*Los Alamos National Laboratory is operated by the University of
California for the United States Department of Energy under
Contract W-7405-ENG-36.*

**Design-only Conceptual Design Report for
Pit Disassembly and Conversion Facility**

Project No. 99-D-141

for the

Department of Energy

(DOE)

Office of Fissile Materials Disposition

(OFMD)

Prepared by

**Stanley Zygmunt
Lowell Christensen
Charles Richardson**

**University of California
Los Alamos National Laboratory
The Facilities, Security and Safeguards Division
Los Alamos, NM 87545**

and

**Fluor Daniel, Inc.
Española, NM**

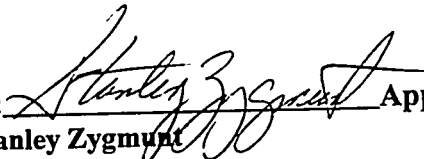
Submitted by:  **Approved by:** _____

**Stanley Zygmunt
Team Leader
Los Alamos National Laboratory**

**Andre Cygelman
Director, Materials and
Immobilization Group
Office of Fissile Materials Disposition**

**December 12, 1997
Revision 0.**

DISCLAIMER

This report was prepared as an account of work sponsored by an agency of the United States Government. Neither the United States Government nor any agency thereof, nor any of their employees, makes any warranty, express or implied, or assumes any legal liability or responsibility for the accuracy, completeness, or usefulness of any information, apparatus, product, or process disclosed, or represents that its use would not infringe privately owned rights. Reference herein to any specific commercial product, process, or service by trade name, trademark, manufacturer, or otherwise does not necessarily constitute or imply its endorsement, recommendation, or favoring by the United States Government or any agency thereof. The views and opinions of authors expressed herein do not necessarily state or reflect those of the United States Government or any agency thereof.

DISCLAIMER

Portions of this document may be illegible electronic image products. Images are produced from the best available original document.

Table of Contents

EXECUTIVE SUMMARY	v
1.0 GENERAL DESCRIPTION OF PROJECT	1
2.0 PROJECT JUSTIFICATION.....	2
2.1 Impact if Not Funded.....	2
3.0 DESIGN CONCEPT	3
3.1 Process Description	3
3.2 Assumptions.....	3
3.2.1 Program Assumptions	3
3.2.2 Process-specific Assumptions	3
3.2.3 Site Options	3
3.3 Project Cost and Schedule.....	4
3.3.1 Project Cost	4
3.3.2 Project Schedule.....	4
3.4 Integration with Other DOE Sites.....	5
4.0 CONSIDERATIONS EXTERNAL TO THIS PROJECT	6
4.1 Alternatives to Proposed Project	6
4.1.1 No Action	6
4.1.2 New Greenfield Facility.....	6
4.1.3 Existing Buildings	6
4.1.4 Other Alternatives	7
4.2 Relationship to Other Projects.....	7
5.0 DESIGN BASIS	8
5.1 Process Description	8
5.1.1 Pit Receiving and Staging	10
5.1.2 Pit Disassembly.....	10
5.1.3 Conversion to Plutonium Oxide	11
5.1.4 Product Packaging, Decontamination, and Nondestructive Assay	12
5.1.5 Product Storage Vaults and IAEA Inspection.....	13
5.1.6 Product Shipping.....	13
5.1.7 HEU Processing and Staging	14
5.1.8 Declassification Processing.....	14
5.1.9 Waste Management	14
5.1.10 IAEA Accommodations	15
5.2 Site and Building Requirements	16
5.2.1 Capacity	16
5.2.2 Building Design.....	16
5.2.3 Utilities and Services	18
5.2.4 Communications.....	20
5.2.5 Instrumentation and Control	20
5.2.6 Human Factors Engineering.....	21
5.2.7 Safety	21
5.2.8 Operability and Maintainability	22
5.2.9 Decontamination and Decommissioning	23
5.2.10 Confinement and HVAC.....	24

5.2.11 Safeguards and Security	25
5.2.12 Environmental Safety and Health Monitoring	26
5.2.13 Criticality	26
5.3 Process Functional Requirements	27
5.3.1 Pit Receiving and Staging	27
5.3.2 Pit Disassembly	30
5.3.3 Conversion to Plutonium Oxide	32
5.3.4 Product Packaging, Decontamination, and NDA	35
5.3.5 Product Storage Vaults and IAEA Inspection	39
5.3.6 Product Shipping	41
5.3.7 HEU Processing and Staging	42
5.3.8 Declassification Processing	44
5.3.9 Waste Management	44
5.3.10 Analytical Lab	45
5.3.11 Control Room	45
5.3.12 Change Room	46
5.3.13 Offices and Related Facilities	46
5.4 Management and Information Systems	46
5.5 External Drivers	47
6.0 DESIGN CONCEPT	48
6.1. Project Design Description	48
6.1.1 Process and Process Support Design Descriptions	49
6.1.2 Facility Systems/Elements	57
6.1.3 Systems Engineering	70
6.2 Energy Conservation Approaches	71
6.3 Utility Assessment	71
6.4 Environmental Considerations	71
6.4.1 Air Quality	71
6.4.2 Water Quality	72
6.4.3 Waste Generation	73
6.4.4 Pollution Prevention	73
6.5 Facility and Equipment Maintenance Considerations	73
6.6 Safety Considerations	74
6.7 Safeguards and Security Considerations	74
6.7.1 Physical Security	74
6.7.2 Material Control and Accountability System	74
6.8 Host Site Integration	76
6.9 Conceptual Drawings	78
6.10 Preliminary Equipment List	78
7.0 PROJECT MANAGEMENT AND IMPLEMENTATION	79
7.1 Project Management Team and Responsibilities	79
7.1.1 OFMD Project Manager	79
7.1.2 Contracting Officer	79
7.1.3 Contracting Officer's Representative	79
7.1.4 Operations Office Project Manager	79
7.1.5 Architect-engineer Project Manager	80
7.1.6 Laboratory Technical Design Consultant	80
7.2 Project Management System	80

7.2.1 Work scope and Technical Baseline Management.....	80
7.2.2 Cost Control.....	80
7.2.3 Schedule Control.....	80
7.3 Project Execution	81
7.4 Procurement Strategy	81
7.4.1 Privatization.....	81
7.4.2 Method of Performance	81
7.5 Risk Assessments	81
7.6 Quality Assurance	81
7.6.1 Project Quality Management Plan.....	81
7.7 Work Breakdown Structure	81
8.0 SCHEDULE BASIS	84
8.1 Engineering Schedule.....	84
8.2 Construction Schedule	84
9.0 COST AND FUNDING PLAN.....	85
9.1 Estimate Basis	85
9.1.1 General Assumptions.....	86
9.1.2 Work Breakdown Structure	86
9.1.3 Total Project Costs.....	86
9.1.4 Construction Wage Rates	86
9.1.5 Indirects and Taxes	87
9.1.6 Engineering and Management.....	87
9.2 Estimate Assumptions and Methodology	88
9.2.1 Sitework.....	88
9.2.3 Site Support Facilities	88
9.2.4 Procurement Equipment.....	88
9.2.5 Main Process Building.....	88
9.2.6 Other Project Costs	88
9.2.7 Management and Operation Costs.....	89
9.3 Contingency	89

References

Acronyms and Abbreviations

Units of Measure

Appendix A: Major Rules, Regulations, Codes, Guidelines, and Standards Impacting the PDCF

Appendix B: Conceptual Design Drawings

Appendix C: Conceptual Design Equipment List

Appendix D: Project Schedule

Appendix E: Cost Summary Reports

EXECUTIVE SUMMARY

This design-only conceptual design report (DOCDR) was prepared to support a funding request by the Department of Energy (DOE)-Office of Fissile Material Disposition (OFMD) for engineering design of the Pit Disassembly and Conversion Facility (PDCF) Project No. 99-D-141. The PDCF will be used to disassemble the nation's inventory of surplus nuclear weapons pits and convert the plutonium recovered from those pits into a form suitable for storage, international inspection, and final disposition.

The PDCF is a complex consisting of a hardened building that will contain the plutonium processes in a safe and secure manner, and conventional buildings and structures that will house support personnel, systems, and equipment. The PDCF uses the Advanced Recovery and Integrated Extraction System (ARIES), a low waste, modular pyroprocessing system to convert pits to plutonium oxide.

The PDCF project consists of engineering and design, and construction of the buildings and structures, and engineering and design, procurement, installation, testing and start-up of equipment to disassemble pits and convert plutonium in pits to oxide form.

The facility is planned to operate for 10 years, averaging 3.5 metric tons (3.86 tons) of plutonium metal per year. On conclusion of operations, the PDCF will be decontaminated and decommissioned.

The project schedule is as follows:

Activity	Duration month/calendar year
Title I Design	10/1998-10/1999
Title II Design	10/1999-3/2001
Construction and Startup	10/2000-10/2004

The Design cost is estimated to be \$46.7 M.

The siting for the Pit Disassembly and Conversion Facility will be determined pursuant to a site-specific Surplus Plutonium Disposition Environmental Impact Statement in a Plutonium Disposition Record of Decision in late 1998. The candidate sites for the facility are Pantex Plant, Savannah River Site, Idaho National Environmental Engineering Laboratory, and Hanford Site.

1.0 GENERAL DESCRIPTION OF PROJECT

The Pit Disassembly and Conversion Facility (PDCF) project consists of design and construction of the buildings and structures, and design, procurement, installation, testing, and start-up of equipment to disassemble pits and convert the plutonium metal to plutonium oxide. The PDCF accepts surplus fissile material in pit form or as plutonium metal and produces plutonium oxide packaged and suitable for storage, international inspection, and disposition. To remove plutonium from the pits, the pits are separated into hemishells with a cutting device, and plutonium is removed from the hemishells by a hydride/dehydride process. The plutonium separated from the pits is converted into oxide. The oxide product is sealed in metal cans, which are leak checked and electrolytically decontaminated. Canned plutonium is placed in storage and ultimately transferred to the disposition process, which is separate from the PDCF. Nonplutonium parts of the pits are separated and recovered for reuse or declassified and disposed of as waste.

The PDCF includes hardened space, a thick-walled concrete building that houses the plutonium processing activities. The plutonium processing building will be a material access area and house the following systems: pit receiving, pit assay and storage, pit disassembly, plutonium metal extraction and conversion to oxide, plutonium oxide packaging, and shipment. Also included are facilities for recovery, decontamination, and declassification of other special nuclear material (SNM) and non-special nuclear material resulting from pit disassembly. Facilities to accommodate International Atomic Energy Agency (IAEA) safeguards are provided for specific portions of the process and facility. In addition to hardened space, conventional buildings and structures house offices, change rooms, an analytical laboratory, a central control room, and systems for packaging, storage, and shipment of waste.

2.0 PROJECT JUSTIFICATION

The Department of Energy (DOE) Record of Decision for the Storage and Disposition of Weapons-Useable Fissile Materials Programmatic Environmental Impact Statement, dated January 14, 1997 announced that DOE's strategy for disposition of surplus plutonium is to pursue an approach that allows immobilization of surplus plutonium in a glass or ceramic materials and burning of some of that surplus plutonium as mixed oxide (MOX) fuel in existing, domestic, commercial reactors. The capability to disposition surplus plutonium does not exist. Accordingly, DOE decided to construct and operate a pit disassembly/conversion facility to convert certain surplus plutonium metals to a plutonium oxide form suitable for disposition by immobilization or reactor burning, as well as other facilities for the disposition of surplus plutonium.

The DOE Record of Decision cited above supports President Clinton's Nonproliferation and Export Control Policy issued in response to the growing threat of nuclear proliferation by providing the Nation with a capability to disposition surplus weapons-useable fissile materials.

2.1 Impact if Not Funded

This project provides the Nation with the capability to convert surplus plutonium in pits and other pure plutonium metals to a form suitable for disposition. If this project were not funded the result would be failure to carry out President Clinton's policy to reduce the threat of nuclear proliferation.

3.0 DESIGN CONCEPT

3.1 Process Description

The Advanced Recovery and Integrated Extraction System (ARIES) is a modular, low-waste system that can disassemble pits and convert the plutonium to a stable, unclassified oxide form, assayed and packaged in a decontaminated container. ARIES consists of interconnected glove box modules and a nondestructive assay (NDA) module without glove box containment. The modular approach provides system flexibility.

3.2 Assumptions

The following section describes assumptions used to scope the project, to develop the conceptual designs, and to prepare design cost estimates. Assumptions are divided into program assumptions and process-specific assumptions.

3.2.1 Program Assumptions

Program assumptions are high-level assumptions that bound the scope of the project. The program assumptions are the following.

- The PDCF will be designed to process 35 metric tons (38.6 tons) of plutonium from pits and clean metal over a 10-year period.
- The PDCF will be designed to Nuclear Regulatory Commission (NRC) standards, as applicable, with regulatory oversight by the Defense Nuclear Facilities Safety Board (DNFSB).
- The PDCF will be an "IAEA eligible facility".

3.2.2 Process-specific Assumptions

Process-specific assumptions are lower level assumptions that were used to prepare the conceptual layout of the facility and to determine costs in this document. Process-specific assumptions are the following.

- The number and types of pits to be handled are based on "Advanced Recovery and Integrated Extraction System Source Term Fact Sheet" (LA-CP-97-93), a classified document.
- Sufficient process equipment is assumed to provide the capability to process 30% more plutonium than contained in the incoming pits and metal. This provides capacity to recycle products that are off specification and recover from unplanned downtime.
- Process rooms are shielded and spaced so that radiation sources in one room do not contribute detectably to radiation exposures in adjacent rooms at levels above background.
-

3.2.3 Site Options

The PEIS ROD identified four candidate sites for locating the PDCF. The four sites identified are Pantex Plant, Savannah River Site (SRS), Idaho National Engineering Environmental Laboratory (INEEL), and Hanford Site. The location for the facility will be determined in a follow-on, site-specific Surplus Plutonium Disposition Environmental Impact Statement (SPD EIS) ROD. The design of the PDCF is influenced by site location, construction of a new building contrasted to using an existing building, and collocation with the proposed MOX Fuel Fabrication Facility and/or the Immobilization Facility.

The approach for each site, as well as options for collocating the MOX Fuel Fabrication Facility and/or the Immobilization Facility are summarized as follows.

- Pantex Plant – Construct the PDCF as a new building in Zone 4 at the site. Collocation of the MOX Fuel Fabrication Facility as a new building is an option.
- SRS – Construct the PDCF as a new building adjacent to the Actinide Packaging and Storage Facility (APSF) so as to share some common functions with that building. The APSF is a 1997 line-item project designed to receive, store, restabilize, and can plutonium metal and oxide. Collocation of the MOX Fuel Fabrication Facility and/or the Immobilization Facility as new construction adjacent to the APSF are options.
- INEEL – Construct the PDCF in the Fuel Processing Facility (FPF) located at the Idaho Chemical Processing Plant (ICPP) at INEEL. FPF is an existing building that was never used. The MOX Fuel Fabrication Facility would be collocated as a new building if the PDCF is located at INEEL.
- Hanford Site – Construct the PDCF in the Fuels and Material Examination Facility (FMEF) at the site. FMEF is an existing building that was never used. The PDCF would occupy the bottom three levels of the six-level building. Either the MOX Fuel Fabrication Facility or the Immobilization Facility could be located in the FMEF with the PDCF. Construction of the MOX Fuel Facility as new construction adjacent to the FMEF is also an option.

3.3 Project Cost and Schedule

3.3.1 Project Cost

The Design cost is estimated to be \$46.7 M.

The preliminary total project cost (TPC) is estimated to be \$586.4 M.

3.3.2 Project Schedule

The project schedule is summarized as follows.

Project Schedule

Activity	Duration month/calendar year
Facility Title I Design	10/1998–10/1999
Facility Title II Design	10/1999–3/2001
Construction Phase	10/2000–9/2003
Permitting/License Phase	10/1998–3/2004
Startup	10/2003–10/2004
Operation Phase	10/2004–10/2014
Decontamination and Decommissioning	10/2014–10/2016

3.4 Integration with Other DOE Sites

Pits that feed the PDCF will be shipped from the Pantex Plant. Transuranic (TRU) waste generated by the PDCF will be shipped to the Waste Isolation Pilot Plant (WIPP). Highly enriched uranium (HEU) recovered from pits will be shipped to the Y-12 plant at Oak Ridge.

4.0 CONSIDERATIONS EXTERNAL TO THIS PROJECT

4.1 Alternatives to Proposed Project

Alternatives to the project that were considered include:

- no action,
- new greenfield sites, and
- use of existing buildings.

4.1.1 No Action

Under the no action alternative, a pit disassembly and conversion facility would not be constructed nor operated and surplus plutonium could not be dispositioned. Facilities for long term storage of the plutonium would need to be constructed. The no action alternative would preclude carrying out President Clinton's nonproliferation and export control policy on weapons of mass destruction.

4.1.2 New Greenfield Facility

The PEIS analyzed construction of new buildings for the PDCF at greenfield locations at the DOE sites to bound environmental impacts. A greenfield location is an undeveloped area. The greenfield alternative was not further considered for the location of the PDCF because of the relative costs and schedule advantages of using developed sites and existing buildings.

4.1.3 Existing Buildings

OFMD considered the use of existing buildings at the four sites included in the ROD for the PEIS as possible locations for of the PDCF. The following is a brief summary of the buildings proposed and the determinations made at each of the four sites.

Pantex Plant

Pantex proposed a series of existing buildings in Zone 12 to house the PDCF. These included buildings 12-117, 12-66, 12-86, 12-44, 12-42, and parts of 12-116. Because of the lack of consolidated space and the tightness of the space available to house the PDCF in the existing buildings, these building were not considered acceptable for the PDCF.

INEEL

INEEL proposed five buildings at three different locations to house the PDCF. The buildings proposed were: Zero Power Physics Reactor (ZPPR), Fuel Manufacturing Facility (FMF), FPF, Fluorinel Dissolution Process Area (FDPA), and Hot Cell Facilities (TAN-607). ZPPR, FMF, FDPA, and TAN-607 required significant redesign and were not considered acceptable. FPF is being considered for locating the PDCF.

Hanford Site

Hanford proposed two buildings, the FMEF or the Storage Complex (2736-Z) as possible homes for the PDCF. Building 2736-Z was found to be too small. FMEF is being considered for locating the PDCF.

Savannah River Site

SRS proposed using space in F-Canyon. The future of F-Canyon after 1999 is uncertain, insufficient space is available, and the configuration of the space does not complement layout of the PDCF. F-Canyon is not a viable location for the PDCF.

4.1.4 Other Alternatives

One other alternative that was considered was commercialization of the PDCF. This is addressed under procurement strategy in Chapter 7.

4.2 Relationship to Other Projects

The PDCF supplies the plutonium oxide needed to operate the MOX Fuel Fabrication Facility and the Immobilization Facility. Therefore the operation of the PDCF must precede the operation of these two related projects.

5.0 DESIGN BASIS

This section includes the PDCF processes, the functional requirements for the PDCF processes, the management and information systems required, the site and building requirements, and the external drivers—the regulatory requirements that must be satisfied.

Process descriptions and functional requirements are based on using the ARIES process as the baseline technology for pit disassembly and conversion. Functional requirements are sufficiently detailed to allow identification and estimation of design costs for the facility, the process, and the support systems.

5.1 Process Description

This section describes the processes of the PDCF, from receiving pits as input material, through processing and generation of plutonium oxide product, to handling and disposition of other parts and materials. The discussion is based on and supported by a library of technical fact sheets that describe each process in detail. The description follows the processes shown schematically in Fig. 5-1, Material Balance. These processes are defined by the Logic Flow Diagram for Pit Disassembly and Conversion for Fissile Material Disposition (LA-UR-97-753), Fig. 5-2, which illustrates in more detail the processing steps and decisions required in each area and processing module.

A classified version of Fig. 5-1 has been prepared showing the yearly average flow of all materials in the pits identified for material disposition. The classified material balance provides fundamental information used to bound the facility conceptual design and the cost estimates given in this document. The material totals are classified information and cannot be presented in this document.

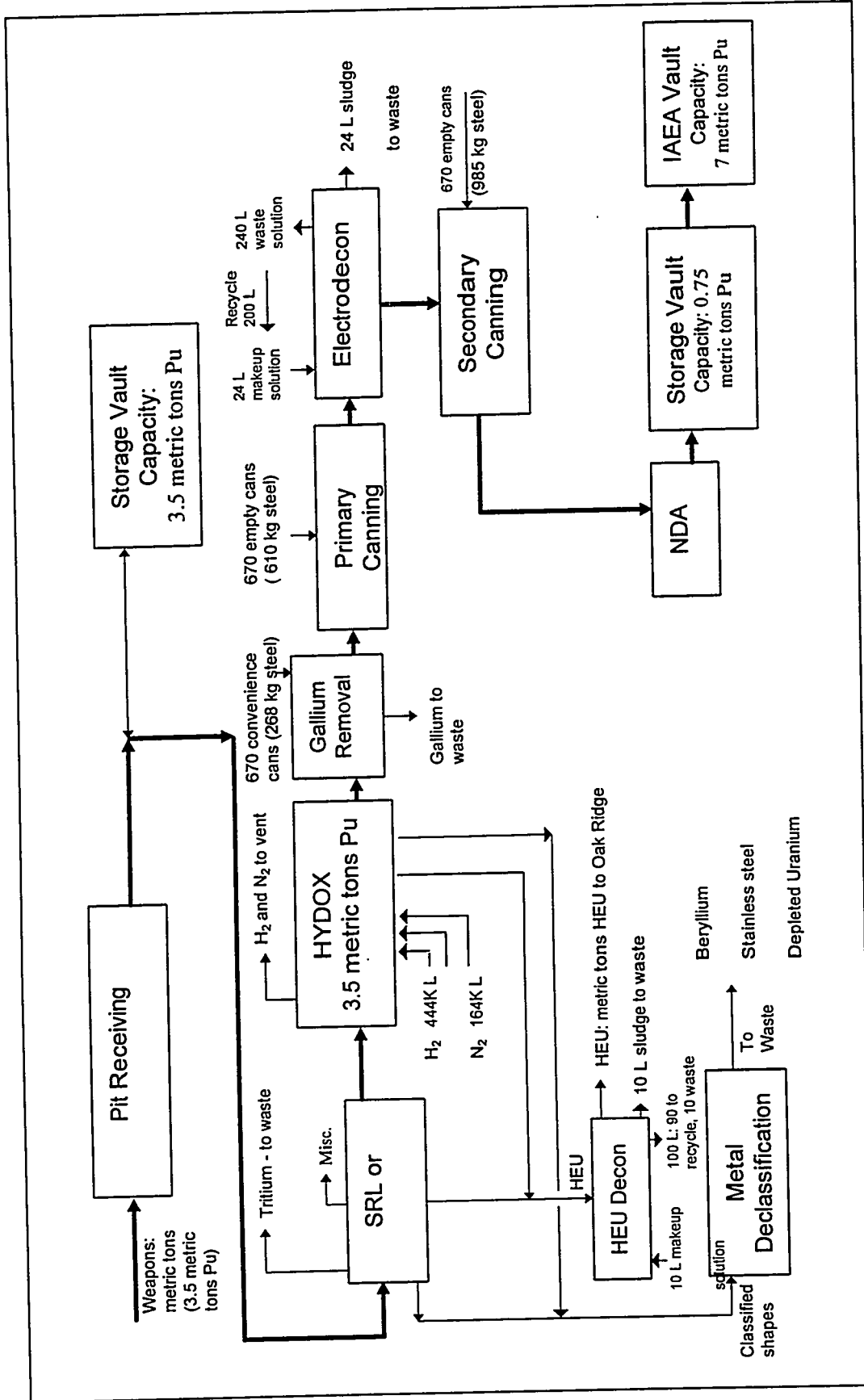

Fig. 5-1. Material balance, yearly throughput.

5.1.1 Pit Receiving and Staging

Pits and plutonium metal are transported to the PDCF from various DOE sites. This section focuses on how the pits and plutonium metal are received, unpacked, and put in temporary storage until processing in the PDCF.

5.1.1.1 Pit Receiving

Pits are transported in fail last (FL) containers attached to a cargo-restraining transport (CRT) fixture in a secure safe transport (SST). The SST arrives at the site, the CRTs are unloaded from the truck, and the FL containers are removed from the CRTs.

A transfer check and material confirmation are completed on the FL container. If the shipment is accepted, the FL container is moved to a short-term storage vault. If the shipment is rejected, the FL container is loaded back onto the CRT, which is loaded back onto the SST to be returned to the shipper.

The FL container is moved from the short-term receiving vault and unpacked. The atmosphere of the inner container holding the pit is tested for tritium. If the pit container atmosphere contains tritium, the pit will remain in the inner FL pressure container and either be moved directly to the special recovery line (SRL) or to vault storage.

If the pit container atmosphere does not contain tritium, the pit is removed from the inner FL pressure container and swiped for surface contamination. If it has no surface contamination, a decision is made whether or not the pit can go directly to processing in the bisector module. If the pit cannot go to processing, it is packed in a holder (referred to as a birdcage) and placed in a pit storage vault. If there is surface contamination, the pit will be stored in the inner pressure container in the vault or sent to hydride/oxidation (HYDOX) processing.

Empty FL containers are surveyed, decontaminated if needed, certified clean, and repacked in CRTs for shipment and reuse.

5.1.1.2 Pit Staging Vault

Clean pits in holders, metal pieces in shipping containers, or contaminated pits in their inner FL pressure containers are stored in the pit vault. This vault will hold up to one year's capacity to provide surge capacity between shipping and processing.

5.1.2 Pit Disassembly

Pits are disassembled in one of two processes, depending on the nature of the pit. Generally, pits are opened in the bisector module, and those pits containing tritium are handled separately in the SRL.

5.1.2.1 Special Recovery Line

Those pits containing tritium are disassembled in the SRL. Pits moved to this line are unpacked from the inner FL pressure container and enter the line using equipment and techniques that capture tritium. The inner FL pressure container is decontaminated, certified clean, and returned to pit receiving for reassembly in an FL container.

Plutonium and HEU are separated from parts that are not SNM in the SRL. Plutonium metal is processed in a vacuum furnace that drives off tritium and produces a metal ingot. The tritium is captured and packaged as low-level waste (LLW). The plutonium ingot is assayed to provide input

FIG. 5-2.
 LOGIC FLOW DIAGRAM FOR PIT
 DISASSEMBLY & CONVERSION FOR
 FISSILE MATERIAL DISPOSITION

REVISION 2
 MARKED FOR DELETION
 NOTE NOT A REPRESENTATION

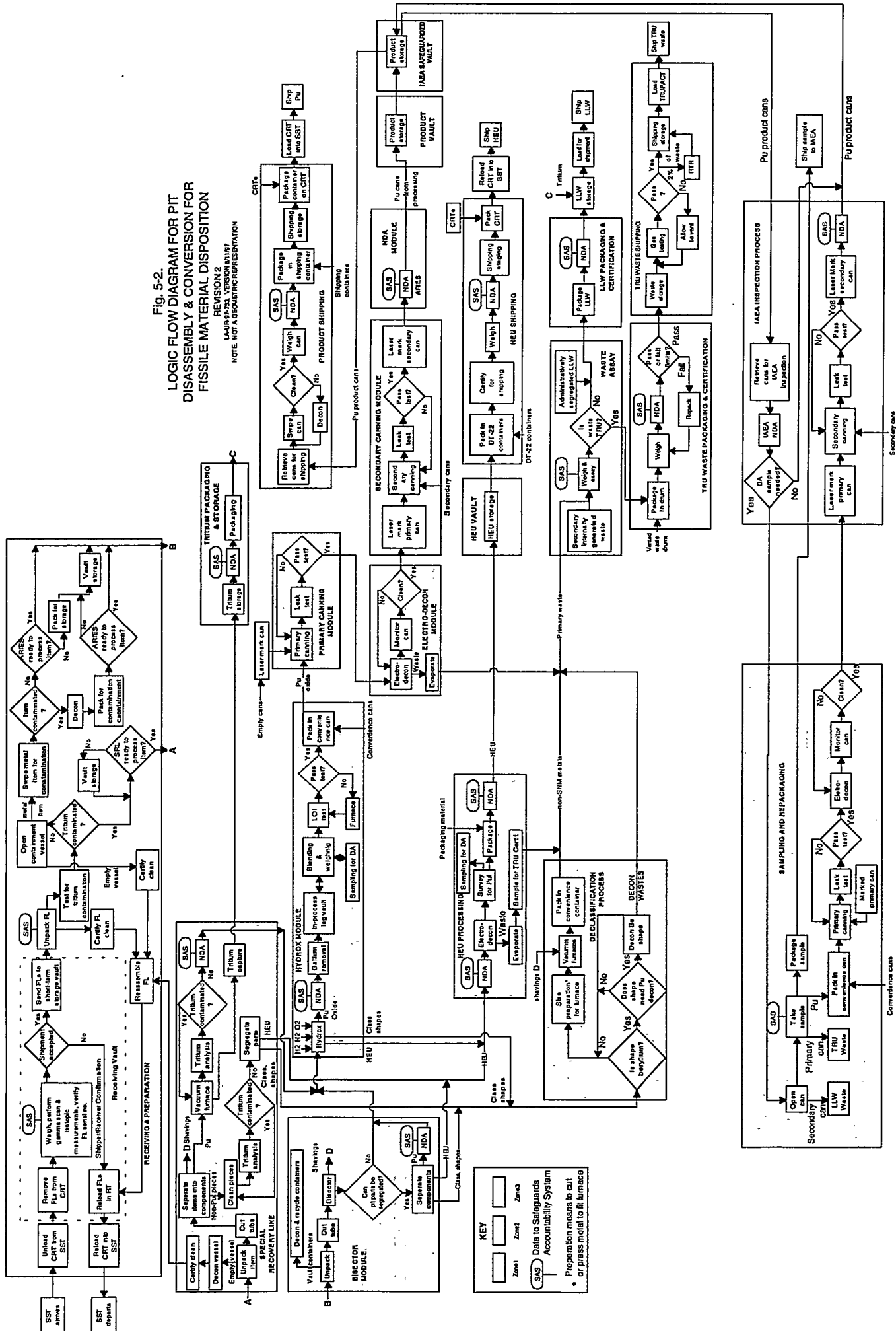

information for accountability. It is tested for tritium and if it is tritium-free, it is sent to a HYDOX reactor in a HYDOX module. If tritium is detected, the ingot is reprocessed in the vacuum furnace.

Nonplutonium pieces are decontaminated and certified clean. HEU from the SRL is then sent to HEU processing and classified shapes are sent to declassification processing. Metal shavings are collected and sent to declassification furnaces.

5.1.2.2 Bisector Module

Those pits that do not contain tritium from pit preparation come to the bisector module. These pits enter the glove box line through a drop box. Surface-contaminated pits moved to this line are unpacked from the vault storage or inner FL container and enter the line using equipment and techniques that control the spread of contamination.

Pit tubes are cut off the pit and the pit is cut into two hemispheres using the pit bisector. Bonded hemispheres are sent to a HYDOX module. If possible, the nonbonded pits are disassembled into plutonium, HEU, and non-SNM classified shapes. The plutonium parts are assayed to provide input information for accountability and sent to a HYDOX reactor in a HYDOX module. HEU is sent to HEU processing and classified shapes are sent to declassification processing. Metal shavings are collected and sent to declassification furnaces.

5.1.3 Conversion to Plutonium Oxide

Plutonium parts are converted to plutonium oxide, PuO_2 , by pyroprocessing. In this process the plutonium is reacted in succession with hydrogen, nitrogen, and oxygen at controlled temperatures and pressures to produce the plutonium oxide product. HYDOX, described below, is the baseline technology for converting plutonium to plutonium oxide. In addition to converting the plutonium metal to oxide, gallium is removed to facilitate disposition.

5.1.3.1 HYDOX Module

Bonded hemispheres from the bisector, plutonium metal from the SRL and from nonbonded pits, and nonpit plutonium metal are conveyed to a HYDOX reactor in a HYDOX module. In the reactor, plutonium reacts with hydrogen to form a hydride. The hydride is reacted with nitrogen to form a nitride that is then reacted with oxygen to produce the oxide product. Hydrogen and nitrogen are vented as reaction products.

The product is collected from the bottom of the reactor and assayed. This assay provides input information for accountability. It confirms that the plutonium metal entering the reactor leaves as oxide. The oxide is then transferred in a convenience can to the gallium removal module.

HEU from the HYDOX reactor goes to HEU processing and non-SNM classified shapes go to declassification processing.

5.1.3.2 Gallium Removal

Plutonium oxide from the HYDOX reactor is placed in a gallium removal reactor where the plutonium oxide is heated and the gallium oxide is reduced to a volatile form that is collected in a vacuum trap. Gallium oxide will be collected and sent to TRU waste assay. The plutonium oxide is stored in an in-process lag vault and then combined in a convenience can with oxide from other batches to meet long-term storage weight requirements.

The oxide in the convenience can is sampled for destructive analysis, and loss-on-ignition (LOI) testing is done on the contents of each can. Oxide that fails the LOI testing is stabilized in a furnace and retested. The oxide is then mechanically sealed in the convenience can and sent to primary canning.

5.1.4 Product Packaging, Decontamination, and Nondestructive Assay

After the plutonium oxide product is assayed and blended, it is sealed into inner and outer cans, also called primary and secondary cans, for storage until final disposition. These cans are designed to meet standards for long-term storage. After the plutonium oxide is placed in a convenience can, the convenience can is placed in the primary can and sealed. The primary can is then decontaminated electrolytically and laser marked. The primary can is put in a secondary can, which is also sealed and laser marked. Finally, the double-sealed package is assayed and sent to a vault for storage. The canning, decontamination, and assay processes are discussed below.

5.1.4.1 Primary Canning Module

Plutonium oxide is moved from the gallium removal module to primary canning in a sealed convenience can. The convenience can is placed inside a stainless steel primary can that is seal-welded closed and leak tested. The can is rewelded if it fails the leak test. The can is moved to the electrolytic decontamination module when it passes the leak test.

Empty cans are laser marked outside of the module with a serial number that allows the can to be tracked.

5.1.4.2 Electrolytic Decontamination Module

Cans from primary canning are wiped clean, then placed in an apparatus where they are electrochemically cleaned. The apparatus is mounted in a wall that separates two parts of a glove box. The glove box on one side of the wall is contaminated; the other side is clean. When the electro-cleaning cycle is done, the can is rinsed and dried inside that apparatus. When the can is dry, the door on the clean side of the apparatus is opened and the can is surveyed for contamination. If the can is still contaminated, the door is closed and the cleaning process is repeated. If the can is clean, it is removed from the apparatus and the glove box and sent to secondary canning.

The electro-cleaning and rinse solutions are recycled within the module. A portion of the solution is filtered to remove accumulations of metals. Decanted sludge, worn electro-cleaning solution, and spent rinse water are periodically removed from the apparatus. The sludge and solutions are either evaporated or solidified. The water can be condensed and recycled or solidified. The waste generated from electro-cleaning is homogeneous and may contain sufficient TRU isotopes to be classified as a TRU waste. The waste must be sampled and analyzed to meet the requirements of the WIPP waste acceptance criteria (WAC).

5.1.4.3 Secondary Canning

Cans from the electrolytic decontamination module are laser marked to add information about each individual can's contents. The primary can is placed in a secondary stainless steel can that is seal-welded closed and leak tested. The can is rewelded if it fails the leak test. After the secondary can passes the leak test, the secondary can is laser marked with information identifying the can and the contents. The secondary can is then moved to the NDA module.

5.1.4.4 NDA Module

Detailed NDA is done for each can leaving secondary canning. Following the assay, the cans are moved to the product vault.

5.1.5 Product Storage Vaults and IAEA Inspection

Cans of plutonium oxide are stored in vaults; first in a product vault, and then in an IAEA-safeguarded vault where the product can be available for IAEA inspection.

5.1.5.1 Product Vault

Cans of plutonium oxide from the NDA module are accumulated in the product vault until the material is transferred to the IAEA for inspection.

Periodic inspection of the cans in the product vault may be needed to meet the surveillance and inspection requirements for long-term storage.

5.1.5.2 IAEA-safeguarded Vault

When ready for transfer to IAEA safeguards, the cans of plutonium oxide stored in the product vault are moved to the IAEA-safeguarded vault. The exchange is made in the presence of, and verified by, IAEA inspectors. Once the material is under IAEA safeguards, IAEA inspectors must have continuity of knowledge of the material and must be able to observe any handling or movement of the material.

Periodic inspection of the cans in the IAEA-safeguarded vault may be needed to meet the surveillance and inspection requirements for long-term storage.

5.1.5.3 IAEA Inspection

The IAEA periodically removes a representative number of cans from storage to verify their contents. These cans are nondestructively assayed using equipment agreed to by, or under the control of, the IAEA.

If samples are required for destructive assay, an IAEA inspector watches as the cans are opened and samples are removed and shipped to the IAEA lab. The oxide is then repackaged in a convenience can and processed through the PDCF primary canning, electrolytic decontamination, and secondary canning modules monitored by IAEA staff. The can's contents are verified with NDA, and the can is returned to the IAEA vault.

5.1.6 Product Shipping

Cans that are to be shipped from the facility are moved from the IAEA-safeguarded vault to product shipping. The cans are surveyed by swiping to ensure they are not contaminated. Contaminated cans are decontaminated and resurveyed. After being surveyed, the cans are weighed and assayed to close accountability for the material. The cans are packed in a shipping container, the shipping container is packaged into a CRT, and the CRT is loaded onto an SST for shipment.

Lessor packaging for shipping may be used if the material is to be moved to another facility on-site.

Once under IAEA safeguards, the material can only be moved to a location that has an agreement in place with the IAEA.

5.1.7 HEU Processing and Staging

Classified shapes consisting of HEU from the SRL, the bisector module, and the HYDOX reactor are moved to HEU processing. The shapes are assayed to provide input information for accountability, then electrolytically decontaminated to remove any plutonium contamination. The HEU shape is surveyed for residual plutonium. The shape is assayed to account for HEU loss during decontamination, bagged out or put into a convenience can, and moved to the HEU vault for storage.

Similar to the can electrolytic decontamination module, the HEU electro-cleaning and rinse solutions are recycled within the module. A portion of the solution is decanted and filtered to remove accumulations of metals. Sludge from the filter, worn electro-cleaning solution, and spent rinse water are periodically removed from the apparatus. The sludge and solutions are either evaporated or solidified. Water can be recovered and recycled or solidified. The waste generated from electro-cleaning is homogeneous and probably will contain sufficient TRU isotopes to be classified as TRU waste. The TRU waste must be sampled and analyzed to meet the requirements of the WIPP WAC.

5.1.7.1 HEU Vault

HEU shapes from HEU processing are accumulated in the HEU vault to ship to Oak Ridge. The HEU is still in classified shapes and the vault must be partitioned from areas to which IAEA inspectors have access. The vault must also be partitioned to keep HEU separate from plutonium to simplify shipping and receiving.

5.1.7.2 HEU Shipping

HEU is shipped as classified shapes to the Y-12 Plant in Oak Ridge, Tennessee. When sufficient HEU has accumulated in the vault, the HEU is moved to HEU shipping where the material is packed into DOE-approved DT-22 containers. The containers are certified for shipping, weighed and assayed to close accountability for the material, and loaded into CRTs. The CRTs are loaded onto an SST for shipment to Y-12.

5.1.8 Declassification Processing

Non-SNM classified shapes and shavings from the SRL, the bisector module, and the HYDOX reactor are moved to declassification processing. Beryllium parts will be decontaminated. The exact process is not yet defined. There may be additional metal surface decontamination processing, but the requirements and processes have not been defined. The shapes are declassified by melting them in one of several different furnaces. Each furnace is designed to handle a different material. Size reduction of classified parts by cutting and/or pressing may be used to fit multiple parts into the furnaces. The degree of preparation needed is a function of the furnace design.

The melted materials are cast into ingots, placed in convenience containers, and moved to waste assay.

5.1.9 Waste Management

Nonprocess sanitary wastes will be sent to the existing sanitary wastewater treatment plant. Room trash and similar solid wastes will be sent to a landfill.

LLW is assayed to verify that it is LLW and then segregated by waste type. Liquid wastes are to be evaporated or solidified. Wastes are packed for storage where they will accumulate and be shipped to a permitted on-site or off-site treatment or disposal facility.

TRU and mixed TRU wastes are segregated by waste type. Liquid wastes are evaporated or solidified. Wastes are packed in vented drums, assayed, and stored. When drums are to be shipped to WIPP, further testing will be done as necessary to meet current WIPP requirements. For example, to meet the 1997 requirements, the drum gas space would be tested and a random 2% would have contents verified by x-ray. Drums will be loaded in transuranic waste package transporters (TRUPACTs) and shipped to WIPP. TRU waste packaging, storage, and shipping requirements are addressed in more detail in "Waste Isolation Pilot Plant Waste Acceptance Criteria Fact Sheet" (LALP-97-54).

5.1.10 IAEA Accommodations

A portion of the PDCF will be an "IAEA-eligible facility" where the stored material will be offered to the IAEA for inspection. This area will include support areas needed for the IAEA to perform the inspection verification. The specific details of the inspections are to be negotiated with the IAEA. Regular technical discussions between IAEA, DOE, and the operator of the PDCF will assure a facility that can accommodate the IAEA. At this time, the important elements to assure accommodation include the following:

- a clearly identified portion of the facility that will be the IAEA-eligible facility,
- provision for sealing and monitoring the containment of the IAEA-eligible facility,
- space identified as a private office for IAEA inspectors,
- space identified for IAEA inspectors to make independent NDA measurements using IAEA or possibly facility equipment,
- procedures developed for IAEA to take small plutonium samples from selected containers,
- inspectors will be foreign nationals, including some from sensitive countries,
- inspectors may require access to the facility beyond normal working hours,
- inspectors may require access to the facility on very short notice,
- inspectors are under escort by the operators,
- inspectors are extensively trained in radiation safety but will receive site-specific training, and
- during any inspection activity, handling of nuclear material is done by the operator under IAEA direction and observation.

5.2 Site and Building Requirements

The PDCF shall be designed, constructed, operated, and decommissioned in compliance with applicable federal, state, and local laws and regulations. The design life for this facility shall be 20 years.

DOE orders for nuclear facilities include design requirements for criticality safety, radiation protection, confinement, waste management, effluent control and monitoring, physical protection, materials safeguards, structural design, and storage of special nuclear material.

5.2.1 Capacity

The PDCF will have the capacity to process 35 metric tons (38.6 tons) of plutonium in 10 years. The exact number of pits and the materials included in these pits is detailed in the classified mass balance sheet and in "Advanced Recovery and Integrated Extraction System Source Term Fact Sheet," LA-CP-97-93, a classified document.

The receiving vault will have that capacity to store pits and metal equivalent to 3.5 metric tons (3.86 tons) of plutonium, which is one year's processing capacity. The IAEA safeguard vault will have the capacity to store the equivalent of 7 metric tons (7.7 tons) of plutonium as plutonium oxide product, which is two year's processing capacity.

5.2.2 Building Design

5.2.2.1 Physical Construction

The PDCF design shall include all necessary structures, systems, material handling equipment, material control and accountability equipment, vault storage facilities, pit material processing modules, and waste management equipment to accept, assay, and process DOE surplus pits and plutonium metal. The plutonium oxide product will be securely stored in an IAEA safeguarded vault, and all other pit materials will be processed as defined in the Logic Flow Diagram for Pit Disassembly and Conversion for Fissile Material Disposition, LA-UR-97-753.

Processing and storage areas shall be designed to control radiation emissions to acceptable levels and limit the extent of potential contamination in the unlikely event of an accident. The design shall provide for ease of personnel access, material handling, decontamination, operation, and adequate ventilation. Radioactive material shall be handled in shielded material handling areas if it is not contained within acceptable packages for handling and transportation. These areas shall provide shielding to minimize radiation exposure to workers. All concrete surfaces of contaminated or potentially contaminated areas shall be lined or have a surface coating to facilitate decontamination.

Heating, ventilation, and air conditioning (HVAC) equipment and auxiliary mechanical and electrical services shall be provided from service areas that facilitate easy access, optimum space utilization, and low installation and maintenance costs while providing building services. Access shall be provided to accommodate the replacement of equipment. Instrumentation, electrical, and mechanical maintenance and repair service areas shall be provided.

A material handling area shall be within a material access area (MAA) boundary and arranged to allow for smooth and efficient flow of material from the SST unloading/loading dock through CRT handling, material confirmation, unloading and accountability measurement, pit processing, and vault storage. Equipment maintenance, and related line support functions within the MAA shall be arranged near the line operations served.

For increased safety of personnel and security of nuclear material, circulation areas for material handling shall be separate from personnel traffic, where possible. Controlled access to material handling shall be provided through portals for personnel, material, equipment, nonnuclear materials and waste.

5.2.2.2 Shielding

Shielding shall be designed to comply with the on-site personnel protection requirements specified in 10 CFR 835, "Occupational Radiation Protection," and DOE/EH-0256T, and with public protection requirements specified in DOE Order 5400.5, "Radiation Protection for the Public and Environment," and DOE/EH-256T. On-site and off-site personnel exposure shall be maintained as low as reasonably achievable (ALARA), as defined in 10 CFR 835 and DOE/EH-0256T.

The shielding and other system and subsystem components shall be designed in accordance with DOE/EH-0256T, with the objective of meeting ALARA goals and of limiting the effective dose equivalent (EDE) to workers to less than 0.5 rem per year from all sources, based on the workers' predicted exposure time in the normally occupied areas. The neutron quality factors used to calculate the EDE shall be in accordance with recommendations given in ICRP-60.

Shielding and other radiation protection measures shall be provided for areas requiring intermittent access, such as for maintenance, component changes, adjustments of systems and equipment, etc. The projected total EDE from all sources (external and internal) shall not exceed 0.5 rem per year.

Concrete radiation shielding shall comply with American National Standards Institute/American Nuclear Society (ANSI/ANS) 6.4 and American Concrete Institute (ACI) 349 and shall consider the material specifications of ANSI/ANS 6.4.2 where it addresses critical confinement or structural function.

For radiation exposure of the public at the site boundary, the goal for routine operations is 1 mrem EDE per year from all pathways. Public exposure criteria shall be based on the annual dose resulting from postulated, planned, or expected releases from the facility, combined with the annual exposure from other facilities at the site. The sum of the EDE from all sources on the site shall be limited in accordance with the public protection requirements of DOE Order 5400.5 and DOE/EH-0256T.

5.2.2.3 Fire Protection

Fire protection is a DOE facility safety requirement. Fire safety requirements are defined in DOE 420.1, "Facility Safety," DOE 440.1, "Worker Protection Management for DOE Federal and Contractor Employees," and G-420.1/B-0, "Implementation Guide for use with DOE Orders 420.1 and 440.1." Fire protection features shall comply with these DOE Orders and the applicable National Fire Protection Association (NFPA) fire codes or standards.

The main fire protection feature shall be provided through the use of automatic sprinkler systems supplemented with automatic fire detection and alarm systems. All active fire protection systems shall be automatically supervised with alarm annunciators sounding in the fire area, the central fire alarm control panel, and the site fire alarm system. The facility shall be compartmentalized into fire areas as appropriate. Fire suppression water must drain to a critically safe, contained area where it can be sampled to verify no contamination before being released.

A fire hazards analysis (FHA) shall be performed to comprehensively assess the fire risk within individual fire areas in the facility in relation to proposed fire protection features. The FHA shall confirm that the objectives identified in DOE Order 5480.7A and "Guidance on Fire Protection for Fuel Cycle Facilities" are met.

5.2.2.4 Quality Assurance

Quality assurance program requirements shall be in accordance with 10 CFR 830, "Nuclear Safety Management." Application of these requirements shall consider the quality levels defined below. Quality levels shall be assigned to all structures and systems during the preliminary design phase. Components shall be analyzed during the Title II phase of design. Quality Level I or II shall be assigned according to the following criteria.

Quality assurance Level I applies to the following:

- safety class and non-safety class safety systems, structures, and components (SSCs) that have been identified as safety class,
- SSCs that have been identified as mission-sensitive, and
- SSCs that have been identified as having a high economic impact.

Quality assurance Level II applies to all other SSCs.

5.2.3 Utilities and Services

5.2.3.1 Support Facilities

Existing support facilities shall be used whenever possible and cost-effective. Construction of new facilities will be required only when necessary to effectively support the PDCF. Assumed existing facilities that can be used in their current condition or that require only small upgrade expenditures to adequately support the PDCF have been identified for each candidate site.

5.2.3.2 Water Utilities

Treated potable water will be provided for general facility use and employee needs such as showers, washrooms, drinking fountains, restrooms, and emergency showers. In material handling, storage, and waste management operations, potable water is to be supplied only for emergency showers.

Tying into the existing sanitary wastewater treatment system at the site will provide for collection and treatment of sanitary waste. To prevent accidental contamination, sanitary facilities shall not be provided in material handling and storage areas or for waste management operations.

Process wastewater treatment will provide for treatment and disposal of wastewater from fire water and general facility users.

A fire water system will provide fire water to all designated areas in the facility.

Storm water collection provides for impounding storm water from the property protection area (PPA) and the protected area (PA) in segregated ponds. Clean storm water will be discharged to natural drainage channels. Contaminated storm water will be directed to process wastewater treatment.

5.2.3.3 Fuel Utilities

A natural gas distribution system will provide natural gas to utility buildings at those sites where gas is needed to heat the building or provide hot sanitary water. Natural gas shall not be supplied to material handling, material storage, or storage support areas.

5.2.3.4 Gas Utilities

A clean, dry instrument and plant air system will provide facility and instrument air to operational, utility, and maintenance users.

A breathing air system will provide a safe and reliable independent air supply to personnel performing special operational and maintenance activities in the material handling, storage, and support areas.

A liquefied and compressed gas system will provide inert gases for glove box inerting, can welding, and processing, analytical laboratory, and vault operations. Nitrogen and argon may be stored in liquid form, if required, to supply adequate quantities of liquid and gas to users in the PDCF.

Reagent gases will be supplied to the material handling areas to meet capacity needs.

5.2.3.5 Process Support Utilities

A dry vacuum system will provide for evacuation of contaminated air from glove boxes and/or gas locks during glove box operation or transfer of materials.

A wet vacuum system will provide for evacuation of any contaminated wet gases that may enter the air space in glove boxes or liquid storage tanks during liquid transfer operations.

Air monitoring and sampling equipment will provide for the detection of alpha particles in areas where there is potential for airborne radioactive contamination.

5.2.3.6 Electrical

The electrical functions shall be met by the provision of equipment and materials required to power the PDCF and shall include features that satisfy safety, reliability, redundancy, simplicity, and flexibility of operation, and maintenance requirements.

The electrical functions include:

- normal power
- standby power and/or emergency power,
- uninterruptible power supply (UPS),
- lighting,
- grounding, and
- lightning protection.

All electrical design shall conform to the NFPA 70-1990, National Electrical Code, ANSI C2 Handbook, and DOE orders.

Electrical power shall be provided to meet material handling, material storage, and support area functional and facility power requirements. Typical power includes power for the following areas.

Room:

- electrical power for cranes and other mechanical and robotic equipment,
- electrical power for hand tools, criticality and continuous air monitoring (CAM) sensors, security devices, and forklift recharging stations,
- regulated, filtered 110 Vac power for instruments and related equipment, and
- rough-in wiring for several 220 V 3-phase outlets.

Glove box:

- 110 Vac power general outlets,
- 110 Vac power for overhead hoist,
- 110 Vac power for glove box lights,
- 110 Vac power for room control system racks, and
- 110 Vac power for small electrical motors.

Facility power shall be supplied via medium-voltage electrical system panels. Standby and/or emergency power shall be supplied by on-site generator sets that feed power users.

Standby and/or emergency power sources shall be equipped with controls that automatically activate and transfer to standby and/or emergency power on loss of normal power, and have a manually activated transfer on restoration of normal power. Specific power users and loads shall be identified, documented, and implemented in the PDCF design.

A UPS shall provide emergency power to required users. Potential users include computers, alarms, critical equipment, and critical facility instrumentation. The UPS shall provide emergency power to facility functions where continuity is essential.

Lightning protection/grounding shall be provided.

A computer-based control system shall be used to monitor, record, and provide secondary control of electrical distribution systems.

In addition to having 110 Vac outlets, PDCF rooms will have wiring and outlets for 220 Vac service for welding and other needs.

5.2.4 Communications

Communications shall comply with DOE criteria for communications, alarms, and automated data processing centers. Information security shall use proven hardware and software that have passed evaluations by the National Computer Security Center.

The PDCF shall provide an adequate communication system that includes voice, data, and video communications within the facility and between outside worldwide communication centers, as appropriate. Linking of individual functions may be required to satisfy specific requirements for transmission speed, reliability, and security. The following functions shall be included in the design of the PDCF:

- telephone,
- public address,
- alarm,
- radio frequency transmission,
- wide area network,
- video, and
- information security.

5.2.5 Instrumentation and Control

Instrumentation and control (I&C) shall provide the equipment and software required to monitor and/or control the facility systems. The I&C functions shall also interface with other facility

secondary systems including: analytical laboratories, material handling, support services, safeguards and security, and fire protection.

Operating monitoring and controls shall consist of closed-loop control systems and other forms of monitoring and control required in the processing modules.

The operation monitoring and control system shall encompass all monitoring and control functions. The system shall include the instruments required to measure physical variables. The design shall incorporate human factors engineering, operator interfaces, standard and/or custom software, and provisions for training and maintenance.

Distributed control shall comply with DOE general controls criteria. The system shall provide the equipment and software required to monitor and control primary process control systems and some secondary systems.

Distributed control shall include the following:

- process monitoring and control and
- energy management

Distributed control shall be special-purpose, functionally distributed, and microprocessor-based, with hierarchical functions supervised or handled by a host computer. The microprocessor distributed controllers shall perform routine process control functions, various interlock and logic routines, and sequential operations.

5.2.6 Human Factors Engineering

Human factors engineering principles shall be applied to the design where human functions are identified as safety class when interfacing with safety class SSCs, or as identified in the safety analysis for protecting the public and the environment. The following human factors elements will be considered in title design:

- system function and task analysis,
- information availability analysis, and
- analysis against human factors standards.

5.2.7 Safety

5.2.7.1 Safety Analysis

A safety analysis shall be performed for the facility in accordance with DOE Order 5480.23 and shall include a hazard analyses and accident analyses. Additional guidance for accident analyses is provided in DOE-STD-1027. Guidance for hazard analyses is provided in University of California Research Laboratory (UCRL)-15910 and DOE-STD-1027.

5.2.7.2 Safety Classification

The results of the safety analysis shall be used to identify administrative controls, engineered safety features, and barriers to the release of materials. These items are designated "Safety Class" and are designed, built, and tested under the quality standards as set forth in 10 CFR 830.120 and project or site-specific implementation guides.

Mission-sensitive SSCs are determined by engineering analysis and/or calculations to identify the structures and systems whose failure could cause extended downtime resulting in significant program delay that would impact mission continuity.

High-economic impact SSCs are determined by engineering analysis and/or calculation to identify the structures and systems whose failure and/or destruction would result in a high financial risk.

Those SSCs that do not meet any of the above-mentioned classification criteria are designated as non-safety class. Non-safety class SSCs that are important to the facility mission or whose failure could have a high impact on the ability of the facility to meet its mission are called mission-sensitive and high-economic impact SSCs.

The results of hazard analyses, accident analyses, and safety class item identification shall be used to assign natural phenomena hazard (NPH) performance goals and corresponding performance categories in accordance with DOE Order 5480.28. The assigned performance goals and performance categories shall be used to determine the NPH mitigation requirements for SSCs in accordance with DOE Order 5480.28. Additional guidance is provided in DOE-STD-1021 and in DOE-STD-1024-92.

5.2.8 Operability and Maintainability

To satisfy ALARA goals, operational areas shall consider cost-effective designs that incorporate remote and automated operation, including visual access attained through remote controlled devices such as closed circuit television (CCTV). Designs shall include provisions to monitor and alarm on detection of abnormal conditions, abnormal radiation levels, and fires.

The equipment shall meet the maintenance requirements of DOE orders and shall be removable for decontamination, maintenance, and replacement by manual methods such as forklift or hand cart.

5.2.8.1 Operability

The PDCF shall be designed to be comfortable and natural for humans to operate and maintain, in accordance with DOE Order 5480.19. Design considerations shall be given to the guidelines contained in MIL-STD-1472d. The following concepts shall be considered and utilized, where practicable:

- Instrumentation shall be located to permit visual monitoring without drastic shifts of body position. Alarms and annunciators shall be located near the operational personnel and convey the proper action required.
- Equipment shall be accessible for ease of operation and maintenance.
- Lighting levels shall be at or above guidelines for the type of location and work to be performed, including remote operations, as specified in Institute for Environmental Studies (IES) standards.
- Facility operator interactive equipment requiring operators to make interpretive judgments beyond their training levels shall be avoided.

In order to reliably meet the capacity requirements, the following concepts shall be considered and utilized, as practicable:

- Maximize equipment interchangeability
- Locate systems and components, including devices having a marginally acceptable probability of failure, in contact maintenance areas
- Operate power transmission devices at or below the manufacturer's rating

- Limit storage vault equipment to only that equipment required to support storage vault functions
- Utilize proven industrial and commercial equipment
- Consider and implement equipment repair/replacement methods and egress routes
- Provide adequate lag storage for material handling flow interruptions affected by equipment failure and/or maintenance

5.2.8.2 Maintainability

Maintainability criteria and guidelines from Institute for Nuclear Power Operations (INPO)-90-008 and DOE Order 4330.4 shall be considered and implemented, as applicable. Adequate space and environmental quality for equipment maintenance and repair materials storage shall be provided in the material handling area for repair and maintenance of electrical/instrument equipment, mechanical equipment, and manipulator maintenance. The size of the repair facilities should be reviewed to ensure that all equipment can be decontaminated, inspected, or repaired.

In radioactive environments failed equipment may have to be removed, disposed, and replaced. Design for such equipment shall consider and implement the following where practicable:

- Locate higher failure rate assemblies to minimize replacement impact on other adjacent equipment
- Operate and/or service by cranes
- Position for visibility by plan view from crane-mounted remote viewing equipment
- Modularize, where practicable
- Minimize the number and standardize, to the extent practicable, remote handling fixtures
- Provide legible identification

Equipment used in radioactive areas, but of such value as to warrant decontamination and repair, shall consider and implement the following design features, where practicable:

- utilize protective coatings resistant to decontamination solutions,
- minimize contamination traps, such as ledges and crevices,
- modularize, as practicable,
- utilize standard fastening devices,
- utilize fastening devices of dissimilar metal to prevent galling, and
- provide the capability for post-repair qualification.

For the equipment that is located in nonradioactive areas and is contact-maintained, the design shall consider and utilize the following guidelines, where practicable:

- utilize standardized equipment and components,
- position consumables for ease of access,
- provide adequate work space,
- provide adequate lighting, and
- provide for safe isolation by mechanical separation, valving, or electrical disconnection.

5.2.9 Decontamination and Decommissioning

The design of the PDCF shall facilitate decontamination and decommissioning (D&D) so that the facility can be economically decommissioned at a future date. DOE Order 420.1 gives general D&D requirements. Additional guidance is provided by DOE Order 5820 and DOE/EV/10128-1 (Decommissioning Handbook).

The following principles shall be considered and employed to the extent practicable:

- Aisles shall be wide enough to facilitate movement of D&D equipment.
- Areas subject to contamination shall be designed to facilitate decontamination. Liners and coatings shall be selected to withstand decontaminating agents and radiation degradation throughout the life of the facility.
- Surfaces shall be free of crevices, ledges, and/or protrusions that could collect radioactive material.
- Penetrations shall be waterproofed for protection during decontamination efforts.
- Fixtures and outlets shall be sealed.
- Floors shall be nonporous and sloped toward drains to facilitate decontamination. Drains and similar piping shall have physical provisions for cleaning.
- Filters shall be placed as near as practical to the source of contamination to minimize contamination of ductwork.

5.2.10 Confinement and HVAC

The HVAC function shall provide the proper environmental conditions for health, safety, and comfort of personnel, for equipment protection, and, where applicable, for confinement ventilation barriers to limit the release of airborne radioactive or other hazardous material to the environment and to minimize the spread of contamination within the facility as determined by the safety analysis. The number and arrangement of confinement zones and their design requirements shall be determined by analysis. In general, the lowest pressure zone is the glove box atmosphere. The next highest pressure zone is the processing room. The next highest pressure zone is the MAA corridors. MAA corridor pressure is to be maintained negative relative to outside atmospheric pressure.

This function may include supply, return, and exhaust air, air intakes, heating, cooling, and air filtration, and air distribution and discharge.

HVAC equipment shall be designed to satisfy heating and cooling load requirements and to meet all general equipment design and selection criteria contained in the American Society of Heating, Refrigerating and Air-Conditioning Engineers (ASHRAE) Fundamentals handbook, ASHRAE Equipment handbook, ASHRAE Systems handbook, ASHRAE Applications handbook, and ASHRAE Refrigeration handbook.

Primary confinement of nuclear material is provided by the primary containment vessel. To mitigate the consequences of an accidental release of radioactive material and to minimize the spread of contamination, facility design features shall confine contamination to the vicinity of the radioactive source. Confinement shall be achieved by ventilation control (differential pressure), by directing air from uncontaminated areas toward areas of higher contamination, by high-efficiency particulate air (HEPA) or equivalent filtration, and by the use of controlled personnel traffic patterns. Contamination control shall also consider compartmentalization (building, area, room), where appropriate, to further limit the extent of potential spread of contamination.

For areas of the PDCF that could potentially become contaminated, a continuous airflow pattern from noncontaminated areas to potentially contaminated areas and then to normally contaminated areas shall be provided. Consideration shall be given to provide separate systems for accurate temperature and humidity control areas, noncontaminated areas, potentially contaminated areas, contaminated areas, air-ventilated process enclosures (e.g., glove boxes, fume hoods, process off-gas vents, etc.), and inert atmosphere process enclosures.

The design of the PDCF shall ensure that occupied operating areas comply with DOE orders for normal operating conditions. In addition, the concept of ALARA shall be used when designing

confinement and ventilation systems to limit airborne contamination levels. The design shall ensure that respirators are not required to meet the dose limits for normal operations. An effective climate control system shall maintain temperature and humidity at an acceptable level between the humans and the environment.

In areas of the facility where plutonium is processed, the following functional requirements apply:

- Primary confinement shall consist of physical barriers, enclosures, glove boxes, fume hoods, piping, vessels, tanks, etc., that contain plutonium, in addition to their associated ventilation system. Its principal function is to prevent the release of plutonium to areas other than where processing operations are normally conducted.
- An inert atmosphere, specified by process requirements, shall be required in each plutonium processing module.
- The supply air to plutonium processing modules shall be filtered by HEPA filters at the ventilation inlet to the enclosure and area confinement barriers to prevent the transport of contamination in the event of a flow reversal.
- HEPA filters shall be installed at the interface between the plutonium processing modules that confine the process and the exhaust ventilation system to minimize contamination of exhaust ductwork.
- Separate exhaust ventilation system ductwork and the initial two stages of filtration shall be designed for exhaust air from enclosures that confine plutonium processing.

5.2.11 Safeguards and Security

Strategies for the protection of SNM and vital equipment shall incorporate the applicable requirements identified in DOE Order 5632.1C, "Protection and Control of Safeguards and Security Interests," in its implementation manual, DOE Order 5632.1C-1, "Manual for Protection and Control of Safeguards and Security Interests," and in 10 CFR 73.

To comply with the DOE orders, the PDCF must be designed to meet the delay time for accessing the nuclear materials by an outside intruder.

A denial strategy shall be used for the protection of a safeguard and security interest where unauthorized access presents an unacceptable risk. Programs shall be designed to prevent unauthorized control.

Safeguards and security interests shall be protected and controlled to preclude or minimize unauthorized disclosure, loss, destruction, modifications, theft, compromise, or misuse.

Protection and control shall be provided in a graded, cost-effective fashion, in accordance with the potential risks to the national security and/or the health and safety of workers, the public, and the environment.

Protection and control afforded safeguards and security interests shall be based upon the Design Basis Threat Policy by the Director of Security Affairs, as well as local threats, and consideration of emergency situations, including disasters.

Physical protection includes a wide variety of security concerns including personnel security, computer/information security, technical security countermeasures (TSCM), classified matter, badging, and protective forces.

The goal of the design is to reduce risks associated with nuclear material diversion/theft and sabotage to an acceptable level while minimizing protection costs.

SNM Category I security requirements for the facility that contains the PDCF must be implemented.

In-process lag vaults will meet requirements for secure storage.

Storage vaults shall meet security requirements defined in DOE orders 5633.3B and 5632.1C. Vaults will be equipped with a CCTV, a door alarm, and motion sensors to control and detect unauthorized entrance.

5.2.12 Environmental, Safety, and Health Monitoring

Environmental, Safety, and health (ES&H) monitoring shall be provided to monitor releases to the environment, personnel at the facility, and conditions at the facility site and surrounding environment in compliance with DOE Order 5400.1. ES&H monitoring shall use manual monitoring operations and data gathering, as well as a special-purpose computer system, to acquire and report data and alarms and to display status. ES&H monitoring shall provide the following minimum functions and equipment to support requirements for sampling, monitoring, data acquisition, and recordkeeping:

- Instrumentation for monitoring and alarm of radiation, radiological contamination, and nonradiation/hazardous material conditions. Alarm for environmental releases and trends for potential exposures and releases. Acquisition and reporting of data from automatic and manual monitoring instrumentation including the following: personnel survey, liquid effluent, stack effluent (isokinetic), hazardous gas, criticality, area radiation monitors, and continuous air monitors.
- Self-monitoring alpha monitoring and alarm equipment will be located near egress portals and at each glove box module.
- Maintenance of data for personnel health records, surveys, inspections and evaluations of hazardous areas, instrument calibration, threshold limits, and administrative records.
- Air sampling and monitoring for radioactive and hazardous materials.

ES&H monitoring shall provide the following functions:

- Display and alarm of radiation, contamination and, if present, nonradiation/hazardous material conditions for facility personnel.
- Display and alarm for environmental releases.
- Data acquisition and display capability for measurement of signals received from monitors located throughout the storage facility.
- Data handling capability including short-term data storage, data retrieval, manual entry, and hard copy generation.
- Interface allowing data transfer to and from other facility computer systems, as required.

An uncontaminated work surface for the radiation control technician's (RCT's) alpha counter, liquid scintillation counter, and associated paperwork will be required in processing areas, as well as storage for standard(s), check sources, swipe material, and other incidentals.

5.2.13 Criticality

Functional design features shall satisfy the nuclear criticality safety requirements of DOE Order 5480.24, DOE 420.1, Section 1300-4, DOE Order 5480.5, and the ANSI/ANS 8 series on nuclear criticality. Operations involving plutonium shall be controlled and conducted such that an adequate margin of subcriticality exists during all conditions.

Structures, systems, and components that ensure nuclear criticality safety shall be safety class and capable of performing their safety functions during and following severe natural phenomena and

man-made events. A criticality monitoring and alarm system (gamma and/or neutron) shall be provided where necessary to meet the requirements of ANSI/ANS 8.3.

5.3 Process Functional Requirements

5.3.1 Pit Receiving and Staging

5.3.1.1 Pit Receiving

The pit receiving area shall be capable of providing the following functions:

- shipping and receiving,
- capability to receive and dock a SST,
- capability for weather protection of the SST,
- capability to unload and stage the contents (CRTs and/or shipping packages) from an SST,
- checking of shipping and receiving papers,
- performing CRT and shipping package smear tests for contamination,
- verifying the integrity of tamper-indicating devices (TIDs), and
- staging of the empty shipping packages and the empty assembly components from one CRT to avoid confusion with those containing SNM.

Cargo Restraint Transporter Handling

The following capabilities shall be provided:

- Disassemble or assemble CRTs using facilities and methods that meet security requirements and minimize operator exposure.
- Perform a smear test on individual shipping packages using methods that minimize operator exposure.

Material Confirmation

The capability shall be provided to perform material confirmation for received packages as specified in DOE Order 5633.3B. A remote material handling and material confirmation measurement method shall be used for performing this operation. This information shall be compared against the shipper's information.

FL Unpackaging/Packaging

An FL is a certified shipping container for shipping pits. It consists of an outer, flanged container and an inner container, sometimes referred to as a "pressure cooker" which holds the pit. The PDCF will include an FL unloading area to include these capabilities:

- sniff test FL containers for tritium,
- remove pit containers from FLs,
- smear-test FLs,
- record weight of pit containers and any identification number, and
- test inner pressure container atmosphere for tritium.

Robotics may be installed to minimize operator exposure from FL unloading activities.

FL Decontamination and Shipping

The capability shall be provided to store empty shipping packages and CRTs apart from those containing SNM. This area may be located outside the MAA. Empty shipping package/CRT storage shall be accessible to both SSTs and commercial trucks for loading and unloading. The capability shall be provided to assay all empty containers and drums leaving the MAA to ensure that they do not contain SNM or actinides.

Functional/Operational Requirements

The PDCF will receive both pits and nonpit plutonium for processing.

Pit receiving and storage are controlled by the rules for the control and accountability of nuclear materials as stated in DOE Order 5633.3B, "Control and Accountability of Nuclear Materials;" DOE excess pits are handled according to this directive.

The facility will be capable of receiving pits in FL containers and plan for the contingency of using AT-400s. The certification of the FL (safety analysis report for packaging [SARP]) expired in May 1997. The FL container may not meet new certification requirements. The baseline mode of arrival for pits at the PDCF is in FL containers delivered by SST. The AT-400 would require new robotic unloading equipment and capability for cutting open the welded containers.

Provision shall be made for testing the atmosphere inside each FL before opening.

The CRTs will be unloaded from the SSTs with a forklift. The receiving area will accommodate the SST and have space for maneuvering the forklift to unload the CRTs in the material access area (MAA). Single FLs will be handled with a drum fixture on a forklift or with a manual drum dolly. Multiple CRTs are shipped per SST, therefore multiple pits will need to be accommodated in the PDCF receiving area.

For a facility to receive a pit, a transfer check is to be done immediately after the SST is unloaded to verify item count, to validate the TID integrity, and to identify and compare the shipping documentation.

The receiving facility then has a timetable that must be followed to strictly comply with the DOE order for external material transfer or must have alternative approved and documented procedures.

A facility would have up to five days to do a material confirmation (if not done at the same time as the transfer check). A material confirmation is accomplished by opening the shipping container, checking the serial number, and completing measurements that verify two measurable SNM attributes. Or the facility has up to 10 days to do accountability measurements consisting of calorimetry and gamma-ray isotopics.

Because some pit designs take longer to complete the receiver's measurement, the facility will have an approved procedure describing what specifically will be done at what time schedule. Where delays in completion of the receiver's measurement will result in a protracted delay in closure of the transaction, a confirmatory measurement may be used to effect a "safeguards closure" of the transaction as stated in the DOE order.

Empty FL containers will be decontaminated, stored, and shipped to other DOE facilities. Storage capacity, separate from FLs containing SNM, shall be available for empty containers.

Decontamination equipment and space will be required to clean empty FL containers and any other contaminated surfaces.

5.3.1.2 Pit Storage Vault

Clean pits in holders or contaminated pits in pressure containers are stored in the pit vault. The pit vault provides surge capacity between receiving and processing.

Functional/Operational Requirements

The storage vault will have storage capacity for one year of operation. This is equivalent to 3.5 metric tons (3.86 tons) of plutonium.

The vault will be built to meet the requirements of DOE's physical protection orders.

The vault will include automated loading and unloading equipment.

Procedures and automated techniques will be in place to periodically verify that unauthorized or unreported changes in inventory have not occurred.

To the extent practical, these operations are to be automated and computer controlled from outside the vault. At the very minimum, these operations shall involve robotic or other mechanical assist equipment such as a crane. Although the control of this mechanical assist may be manual, and the operator may be required to work within the vault, there must be sufficient operator separation that radiation exposure from the items being moved is not a significant concern.

Compartmentalization will be designed to limit the spread of contamination in the event of an accident and to control access to SNM.

The material storage vault shall be provided with a dependable cooling system. Passive convection cooling, if confirmed by detailed analysis, is preferred over an active cooling system for plutonium storage vaults. A passive cooling concept shall not compromise the required confinement capability under all credible circumstances, assuming a single failure in the cooling system.

Remote handling will be designed for placement and retrieval of stored items.

In-place material monitoring and inventory capability will be as required by DOE Order 5633.3B

Items will be physically separated to prevent criticality.

A detection system will warn of unauthorized access to SNM.

A contamination release monitoring and alarm system will be installed.

Structural/Architectural Requirements

The vault walls and roof shall be reinforced concrete, capable of retaining structural integrity during and after design-basis accidents (DBAs) and meeting physical security access delay requirements.

The required openings for air flow shall meet the requirements of DOE 5632.1C. The arrangement of the storage compartments, combined with the fixture holding and the location of stored materials within the compartments shall be designed to assure criticality safe configurations.

The storage compartments shall be designed to retain structural integrity and desired configuration throughout the projected useful life of the facility, including during and after DBAs.

The radiation exposure for personnel from materials stored in this vault should be estimated early in the design process. Shielding will be added to drop exposure to acceptable limits.

Fire Protection – There is no requirement for fire protection in the vault. Combustibles will not be permitted, and fire protection in this area is to consist of only manual extinguishers designed for electrical equipment fires.

5.3.1.3 Preprocessing Material Confirmation

All nuclear materials entering and leaving the PDCF will require material confirmation measurements as detailed in DOE 5633.3B. NDA will be required at the first practical step in the process to get exact accountability information for each pit. This NDA may have to be performed after pit disassembly.

5.3.1.4 Conveyor and Airlock System

A conveyor system will be designed to move materials between PDCF rooms and between processing modules. Processing modules with inert atmospheres will be isolated from the conveyor system by an airlock.

Functional/Operational Requirements

Entry hoods will be available where materials need to be introduced into the conveyor system.

The conveyor system will be designed to move materials efficiently from one processing module to another and from one room to another.

The conveyor system will have sealing systems that prevent the movement of air from the conveyor system into glove boxes with inert atmospheres.

The system will have the capacity to move all materials through the system that will be processed in any given day. This includes pits, pit parts, processed pit materials, and associated tools and materials.

The conveyor system will allow operator control of destination once the trolley device has been called to a given station. (A loaded trolley cannot be called to another location until it is unloaded.)

110 Vac power will be provided for all conveyor control systems, monitors, alarms, and detectors.

5.3.2 Pit Disassembly

5.3.2.1 Special Recovery Line

The SRL will be used to unpack, bisect, and decontaminate pits that are tritium contaminated.

Functional/Operational Requirements

SRL will have the capacity to process 100% of the PDCF throughput rate.

The SRL will include FL inner container unloading, a glove box or area in the bisection glove box for unloading contaminated pits.

The inner FL container will be decontaminated and swiped to verify that it is clean. It will then be sent back to the pit receiving area.

A bisector or lathe will be required to cut pits in half.

Robotics will be developed for pit separation. Nested components will be separated by remote control or with as many remote operations as possible. Separated plutonium will go to the furnace glove box. Oralloid and non-SNM materials will be cleaned, tested for tritium, and sent on to other PDCF processing.

Contaminated plutonium parts will be melted in a vacuum furnace. A small amount of argon will be used to sweep the furnace atmosphere. This will discharge through a light vacuum system into a getter bed that will capture tritium. The vacuum furnace operating time will be the most time-consuming step. The metal will be melted and held at temperature for a set time to ensure tritium removal.

The SRL will include a minimum of two bisectors or lathes, two modules for robotic pit disassembly, four furnaces total, a tritium capture module, and two modules for decontamination and testing of nonplutonium parts.

Furnaces will be resistance or induction furnaces.

Melted plutonium will be tested to verify tritium removal and then sent to HYDOX processing or lag storage.

Each glove box and furnace atmosphere will be pumped through the tritium cleanup glove box where tritium will either be captured in getters or catalytically reacted with oxygen to produce water that will be captured in mole sieves.

Captured tritium will be collected, assayed, and conveyed to the waste management room.

The glove box atmosphere will be argon.

Utility and Service Requirements

Operating induction furnaces each require 25 kW power supplies/frequency controllers. Backup furnaces could share the same power equipment. Resistance heaters require less power—220 Vac power for furnace heaters.

Confinement Barriers and Heating, Ventilation, and Air Conditioning

The SRL room will have a HVAC system independent of the rest of the PDCF because of the possibility of a tritium release.

The room ventilation system would not recirculate room air. It is a once-through system. If the room becomes contaminated with tritium, the room vent system will shut down while the room air is pulled through a tritium decontamination system similar to, but larger than, the tritium decontamination glove box.

Health/Safety Requirements

Tritium monitors will sample room air, and alarms will warn operators of tritium contamination. In alarm conditions, the room air will be interlocked to recycle through tritium-capturing equipment.

5.3.2.2 Bisection

Pits will be removed from storage and conveyed into a bisector module where the pit will be removed from containment, if any, and inspected. Pit tubes will be removed and the pit will be cut in half. Pit parts will be separated if possible, and these pieces will be sent to other modules for processing.

Functional/Operational Requirements

“Bisector” refers to a device that cuts the pit in half. The baseline design is a pit bisector that uses a pipecutter-type blade that minimizes waste. Other bisecting devices, such as lathes, may be used if experience shows a need for another bisection method.

The bisector modules will have the capacity to bisect enough pits in a day to meet the PDCF processing schedule.

The bisector modules have high exposure potential, so robotics and shielding will be in place to minimize operator exposure and to meet the specific exposure limits required by DOE regulations.

Secure glove box storage will be required to store classified vacuum chucks to match the inventory of pit types to be processed. This storage area could serve all bisector and SRL modules.

Secure lag storage will be available where pit halves can be stored to await further processing. Storage capacity will be equal to the daily plutonium processing capacity of the PDCF.

Robotics will be designed and installed to separate nested pit parts.

Each bisector module will require vacuum for the hoist and chuck.

The glove box atmosphere will be argon.

Health/Safety Requirements

A tritium detector and alarm will warn of unexpected tritium contamination.

5.3.3 Conversion to Plutonium Oxide

5.3.3.1 HYDOX

Plutonium metal will be converted to oxide in the HYDOX processing module. The HYDOX process is the baseline technology. In the HYDOX reactor, plutonium will be converted to a hydride. The hydride will react with nitrogen to form a nitride, and the nitride will be reacted with oxygen to form the oxide product.

Functional/Operational Requirements

There will be enough HYDOX reactors to process 3.5 metric tons (3.86 tons) of plutonium in a year. Assume 12 reactors are needed. The number of reactors may change as a result of research and development (R&D) efforts.

Pit parts and plutonium metal will be handled with robotics as much as possible to minimize operator exposure.

Interim secure storage will be available to hold pieces to be processed.

Pit hemispheres and plutonium metal pieces will require separate holding fixtures to hold the piece in position in the reactor.

A reagent-quality hydrogen delivery system will be designed that meets DOE safety review and approval. There will be sufficient capacity to feed each HYDOX reactor in the PDCF.

A reagent-quality nitrogen system will be designed to meet the capacity requirements of all the HYDOX reactors.

Each HYDOX module will have hydrogen measurement and alarm instrumentation. A high hydrogen alarm will sound in the processing room and in the central control room.

Each reactor will have a vacuum system to remove oxide from the reactor crucible and transfer it to convenience cans.

The oxide from each reactor batch will be weighed for input to the accountability system. In addition, there will be NDA performed as needed to meet accountability requirements.

Oxide will be stored in a lag vault to await processing in the gallium removal reactor.

Utility and Service Requirements

Each HYDOX reactor will require 220 Vac power for HYDOX furnace heater. The 220 V powers the power supply external to the glove box. The actual reactor heater is 110 Vdc.

Other Utilities:

- process vacuum system for reactor,
- house vacuum system for overhead hoist,
- limited volume (LV) glove box cooling water, and
- television camera for reactor monitoring.

Reagent Supply:

- hydrogen,
- nitrogen,
- oxygen, and
- helium (for blending with oxygen to control reaction rate)

The glove box atmosphere will be argon.

A reactor heat removal system will be designed to control reactor surface temperature. If chilled water is used, it will be a LV system to meet criticality control limits.

5.3.3.2 Gallium Removal

Several methods for gallium removal have been tested. The baseline approach will be the following. Oxide from HYDOX will be processed in a gallium-removal reactor where gallium sesquioxide, Ga_2O_3 , will be reduced to the volatile gallium suboxide Ga_2O , which will be captured in a cold trap.

Functional/Operational Requirements

Gallium removal reactions and rates are being studied. Assume one gallium reactor will process one batch in 24 hours. Only one reactor will be located in a glove box due to criticality limits.

The following reaction sequence will occur in each reactor:

- Plutonium oxide from two hemispheres will be placed in the reactor crucible.
- The oxide will be heated to approximately 1100°C (2010°F) and a mixture of 6% hydrogen in argon will be directed through the frit crucible bottom, through the oxide. This will continue for at least two hours.
- Gallium suboxide will be captured in a cold trap.
- The reactor will be purged with inert gas to remove hydrogen, and air will be introduced to insure stoichiometric amounts of plutonium and oxygen in the oxide.
- The reactor will cool down, and oxide will be removed from the reactor and sealed in a food-pack can.
- Gallium suboxide will be assayed and packaged as a waste and sent to waste processing.

Utility and Service Requirements

Each gallium removal reactor will require 220 Vac power for furnace heater. The 220 Vac powers the power supply external to the glove box.

Other utilities:

- process vacuum system for reactor and
- LV glove box cooling water

Reagent supply:

- hydrogen,
- air, and
- argon (for blending with hydrogen to control reaction rate).

The glove box atmosphere will be argon.

A reactor heat removal system will be designed to control the temperature in the glove box. If chilled water is used, it will be a LV system to meet criticality control limits.

5.3.3.3 Oxide Preparation

The plutonium oxide from gallium removal will be tested for LOI. If it fails the test, it will be reheated in a gallium removal reactor and retested. After it passes LOI, it will be blended with other oxide batches and loaded into a food-pack can to meet the weight requirements for storage. The food-pack can will be sent to primary canning.

Functional/Operational Requirements

There will be space in the gallium removal module for lag storage of oxide batches for blending.

There will be storage for empty food-pack cans and lids, and there will be a food-pack canning device. Testing, blending, and sealing will be done by remote control as much as possible to minimize operator exposure.

5.3.4 Product Packaging, Decontamination, and NDA

5.3.4.1 Primary Canning

The sealed food-pack can, filled with plutonium oxide in the gallium removal module, will be placed in a stainless steel "inner can" that will be welded in an inert atmosphere.

Functional/Operational Requirements

The stainless steel can, identified as the "inner can," will be used to contain the food-pack can containing processed plutonium oxide.

The inner can is designed to meet the long-term storage requirements of "Criteria for Preparing and Packaging Plutonium Metals and Oxides." (DOE-STD-3013-96, September 1996). The can will be laser-marked with a unique serial number for identification in the ARIES system. Once the plutonium product is placed inside, the inner can will have a lid welded on, and this sealed can will be leak-checked to verify weld integrity.

The PDCF will have two inner canning modules, one as backup. One module will be able to process all cans in the existing production schedule.

Each canning module will include the following equipment:

- Tungsten inert gas (TIG) welder – This welder consists of a power supply located outside of the glove box connected to the grounding cable and torch inside.
- Controller – This controls the welder power and the turntable that turns the primary can during welding. It will be located outside the glove box.
- Turntable system – This holds the primary can and its lid in place and turns at a controlled rate as the welder seals the lid to the can.
- Leak detector – This is a vacuum chamber with a vacuum pump that pulls the chamber gas through a helium detector. The vacuum chamber has a double O-ring seal with an argon purge between the O-rings. This will prevent helium from the glove box leaking into the vacuum chamber to give a false weld-fail indication.
- Space will be available where empty primary cans and lids will be stored in the glove box.
- Robotics will be installed to load the food-pack can into the inner product can and to manipulate the inner can in each processing step in the module.

Utility and Service Requirements

Electrical power requirements:

- welder power supply – 440 V 3-phase, 30 A max.,
- welder controller – 120 Vac 20 A max., and
- turntable motor – 120 Vac 20 A max.

Glove box atmosphere:

- The glove box will have a controlled helium environment for welding with <100 ppm oxygen and <100 ppm moisture. Argon will be supplied to the vacuum chamber for the leak testing sequence.
- Instrumentation will be included to measure oxygen and moisture and transmit the measurement information to the operator's computer console.

- A vacuum system will be connected to the vacuum chamber to evacuate the system to 10^{-6} torr.

5.3.4.2 Electrolytic Decontamination

The welded inner can will be electrolytically decontaminated, checked for contamination, and sent to laser marking.

Functional/Operational Requirements

Two electrolytic decontamination modules will be located in the PDCF, one being for backup. One module has the capacity to meet the PDCF throughput requirements.

Robotics will be developed for moving the inner can through the system weighing, cleaning, and monitoring steps.

The electrolytic decontamination system developed as part of ARIES will be the baseline design.

Each module will have the following equipment:

- Decontamination fixture – This fixture is mounted in the partition separating the radioactive and nonradioactive chambers of the glove box. The radioactive chamber is open to the conveyor system. The fixture has two doors. One opens to the radioactive side for loading, the other opens to the nonradioactive side for unloading.
- Electrolyte manifold and treatment system – The electrolyte and rinse water storage tanks, pumps, and automatic valving used in the decontamination sequence will be isolated from the radioactive side of the decontamination fixture.
- Decontamination solution tank – A tank holds sodium sulfate solution. A pump circulates filtered solution through the decontamination fixture.
- pH control pump – The decontamination solution pH is controlled at >10 by a control system that measures pH and adds 10% sodium hydroxide solution with a small metering pump.
- Rinse water tank – This tank holds rinse water and a small pump circulates the water through the system.
- Heater – An air heater will heat air blowing through the fixture during the drying cycle.
- Alpha measurement system – This will measure the alpha contaminant level on the primary cans immediately before and after removal from the decontamination fixture. The contamination level must be <500 disintegrations per minute (dpm)/ 100cm^3 direct reading (fixed) and 20 dpm/ 100cm^3 swipable reading to go on to the laser-marking process.
- Scales – These will weigh the can so the weight loss associated with electrolytic decontamination can be recorded.

Utility and Service Requirements

Waste treatment systems will be developed for the following wastes:

- Electrolyte solids – The electrolyte solution will periodically build up flocculent iron, nickel, and actinide solids that will be decanted and removed from the decontamination tank. These will be filtered, dried, and packaged as waste.
- Chromium(VI) solution – The filtered solution will contain chromium(VI) that will be reduced to chromium(III) at low pH. This will be precipitated at a pH of 10 and decanted, filtered, and dried.
- Rinse water – Rinse water will be evaporated or solidified and disposed as waste.

Electrolytic decontamination utilities:

- Air purge system – Dry compressed air will be used to purge the decontamination solution tank to dilute and remove hydrogen. Compressed air will also be used to clear the lines after decontamination and after rinsing.
- Direct current power supply # 1: 20 Vdc, 50 A – This controls the electrodes at 4 Vdc and 40 A. It is located outside of the glove box.
- Direct current power supply # 2: the on-off solenoid valves are 24 Vdc, and the control system will include a power supply to actuate the valves.
- Vacuum system – The vacuum system will pull a vacuum on the fixture system to remove water. A wet and/or a dry vacuum system will be used.

Reagents required:

- sodium sulfide,
- sodium hydroxide, and
- sodium metabisulfite to reduce chromium(VI) to chromium(III)

5.3.4.3 Laser Marking

Storage cans will be laser marked with identifying text numbers and codes.

Functional/Operational Requirements

Three laser marking stations will be located in the PDCF: (1) A laser marking station for labeling empty cans before they are put into the canning modules, (2) a robotically loaded and unloaded station for labeling the sealed inner cans, and (3) a robotically loaded and unloaded station for labeling the filled outer can.

The information to be laser-cut on the can surface will be defined by DOE. Cans will be marked to meet the requirements of DOE-STD-3013-96.

Utility and Service Requirements

Electrical power connection: 208 Vac ($\pm 5\%$), 60-Hz, 3-phase, 40-A power connection

Cooling water: 22-22L/min (6-9 gal./min), 10-15°C (50-60° F), 2.7 atm (40 psi) (or Lumonics water chiller).

Operating environment: temperature of 13-30°C (56-86° F) and noncondensing relative humidity, and ventilation system to evacuate any metallic fumes and dust or other airborne contaminants generated from the material being marked.

5.3.4.4 Secondary Canning

The sealed, labeled inner can will be placed in an outer can that will be seal welded in a helium atmosphere and leak checked to verify weld integrity. This outer can is designed to meet DOE-STD-3013-96.

Functional/Operational Requirements

The PDCF will have two outer canning modules, one as backup. One module will be able to process all cans in the existing production schedule.

Each canning module will include the following equipment:

- TIG welder – This welder consists of a power supply connected to the grounding cable and torch inside a chamber that contains a purified helium atmosphere.
- Controller – This controls the welder power and the turntable that turns the secondary can during welding.
- Turntable system – This holds the secondary can and its lid in place and turns at a controlled rate as the welder seals the lid to the can. The outer can may have a top and bottom weld depending on the final design. Bottom welds could be done ahead of time.
- Leak detector – This is a vacuum chamber with a vacuum pump that pulls the chamber gas through a helium detector.
- Robotics will load the inner can into the outer can and move the outer can to the processing stations in this module.

Then processing sequence is as follows.

- A sealed inner can from laser marking will be placed into an outer can.
- The outer storage will be placed on the welding turntable, and a top lid will be positioned and held in place by a fixture that positions it during welding.
- The welding operation will take place in a controlled helium environment.
- The welder controller will start and control the welder and turntable position.
- The welded can will be removed from the welder turntable and placed in a vacuum chamber where a vacuum pump will evacuate the system to 10^{-6} torr. The chamber will be flooded with argon, and the system again evacuated, this time through a helium detector. The system will be engineered to prevent a false reading from the glove box atmosphere. If helium is detected, the outer can will be re-welded and rechecked for leaks.
- After a secondary can passes the leak check, it will be labeled and sent to NDA testing and storage.

Space will be available where empty primary cans and lids will be stored in the glove box.

Utility and Service Requirements

Electrical power requirements:

- welder power supply – 440 V 3-phase, 30 A max.,
- welder controller – 120 Vac 20 A max., and
- turntable motor – 120 Vac 20 A max.

The welding module will have a controlled helium/argon environment for welding with <100 ppm oxygen and <100 ppm moisture.

Health/Safety Requirements

Robotics will be provided to minimize operator exposure.

5.3.4.5 NDA Module

All nuclear materials entering the IAEA vault will require accountability measurements as detailed in DOE 5633.3B.

Functional/Operational Requirements

The product NDA equipment will have the capacity to measure all plutonium oxide product cans coming from the processing modules. It will have the added capacity to measure cans pulled from the IAEA vault for inspection and for shipping.

The NDA methods chosen for assaying product cans must be capable of providing the required accuracy and precision for control of SNM. Material control and accountability (MC&A) criteria require that NDA methods be of proven design and capability.

The product NDA module will consist of instrumentation that will meet or exceed the applicable DOE Order 5633.3B criteria.

The quality assurance (QA) requirements for the assays performed by the measurement system should be met by the facility requirements for measurement control. These requirements include selecting and qualifying the measurement method, training and qualifying the measurement personnel, a sampling program, routine testing and calibration, and statistical analysis. The equipment must be self-calibrating, or the calibrations must be automated easily, using appropriate nuclear material standards.

Safety performance must be enhanced by automatic (robotic) loading of the equipment. An automated system will conduct the assays by robotic manipulation of input components between the various instruments. This will reduce handling and radiation exposure to operating personnel.

Robotics – A programmable robot will be used within the NDA module to transfer the input components between the various assay instruments. The robot will be capable of moving and manipulating any anticipated PDCF load up to 10 kg (22 lb).

Utility and Service Requirements

NDA equipment utilities:

- SNM working standards for calibration and measurement control,
- liquid nitrogen (LN) service for the segmented gamma-ray scanner (SGS) and gamma-ray infrared scanner (GRIS), and
- chilled water to cool equipment such as calorimeters.

Security/Safeguards Requirements

Robotic equipment will be employed to permit unattended operation in the NDA room. The walls separating this area from other areas within the MAA must be of concrete and have door frames designed to permit the addition of securely lockable and alarmed doors when required. Provision for addition of other types of remote surveillance shall be provided. Shielding walls will be designed to meet NDA design requirements.

Computer interfaces will be designed to prevent IAEA access to restricted information.

5.3.5 Product Storage Vaults and IAEA Inspection

5.3.5.1 Product Vault

Plutonium oxide stored in long-term storage cans will be stored in a PDCF product vault to await being transferred to the IAEA.

Functional/Operational Requirements

The product vault will have storage capacity for three months of PDCF production.

The construction requirements will be the same as for the IAEA vault defined below.

5.3.5.2 IAEA Vault

Plutonium oxide stored in long-term storage cans will be stored in a vault safeguarded by the IAEA.

Functional/Operational Requirements

The IAEA vault will be sized to hold the oxide product from two years of operation.

The vault will be built to meet the requirements of DOE physical protection orders.

The vault will include loading and unloading equipment.

A system will be set up to periodically verify that unreported changes in inventory have not occurred.

To the extent practical, these operations are to be automated and computer controlled from outside the vault. At the very minimum, these operations shall involve robotic or other mechanical assist equipment such as a crane. Although the control of this mechanical assist may be manual and the operator may be required to work within the vault, there must be sufficient operator separation that radiation exposure from the items being moved is not a significant concern.

Compartmentalization will be designed to limit the spread of contamination in the event of an accident.

The material storage vault shall be provided with a dependable cooling system. Passive convection cooling, if confirmed by detailed analysis, is preferred over an active cooling system for plutonium storage vaults. A passive cooling concept shall not compromise the required confinement capability under all credible circumstances, assuming a single failure in the cooling system.

Remote handling will be designed for placement and retrieval of stored items.

In-place material surveillance and inventory capability will be installed as required by DOE Order 5633.3B.

Items will be physically separated to prevent criticality.

A detection system will warn of unauthorized intrusion.

A contamination release monitoring and alarm system will be installed

Structural/Architectural Requirements

The vault walls and roof shall be reinforced concrete, capable of retaining structural integrity during and after DBAs.

The arrangement of the storage compartments, combined with the fixture holding and the location of stored materials within the compartments shall be designed to assure criticality safe configurations.

The storage compartments shall be designed to retain structural integrity and desired configuration throughout the projected useful life of the facility, including during and after DBAs.

The radiation exposure for personnel from materials stored in this vault should be estimated early in the design process. Shielding will be added to drop exposure to acceptable limits.

Fire Protection – There is no requirement for fire protection in the vault. Combustibles will not be permitted, and fire protection in this area is to consist of only manual extinguishers designed for electrical equipment fires.

Confinement Barriers and HVAC

Except for penetrations for cooling air, the vault will have no exterior penetrations.

Security/Safeguards Requirements

Vault – The vault shall meet DOE security requirements and the security requirements negotiated with the IAEA.

Vault control room – The personnel access into this area shall be controlled.

The area will be equipped with a CCTV, a door alarm, and motion sensors to detect unauthorized entrance.

5.3.5.3 IAEA Inspection Area

Functional/Operational Requirements

The PDCF will have an IAEA inspection room to contain IAEA NDA equipment. The IAEA inspection room may be collocated in the product NDA area if that accommodation is negotiated with the IAEA.

The NDA equipment will identify contents of product cans under IAEA safeguards. Handling of nuclear material will be done by PDCF operators under IAEA direction and observation.

Security/Safeguards Requirements

Physical protection, access control, and computer/information security measures will be required to assure that the IAEA will not be permitted to view any process associated with classified information and will not have access to computer systems or operational processes that handle or generate classified information. When agreed to by the US government, the IAEA may have direct access to measurement information generated on the PDCF NDA equipment, but will not have access to the accountability database. Specifically, the IAEA will not have access to information/data that the IAEA has not been granted access to by treaty or other agreement with the United States.

5.3.6 Product Shipping

Functional/Operational Requirements

Product shipping will be under IAEA oversight.

Space will be required for CRT assembly and disassembly.

Cans of oxide will be transferred to DOE-approved oxide shipping containers and loaded on CRTs.

Engineering controls will be in place to minimize exposure

Material confirmation measurements will be documented at the PDCF shipping area and at the receiving site.

Security/Safeguards Requirements

The loading and shipping will be done with no IAEA access to classified materials or parts.

5.3.7 HEU Processing and Staging

5.3.7.1 HEU Processing

HEU (oralloy) pit parts will be electrolytically decontaminated, stored, and shipped to the Y-12 Plant at Oak Ridge.

Functional/Operational Requirements

HEU parts will be electrolytically decontaminated in a decontamination fixture.

An electrolyte manifold and treatment system will be required. This will include:

- Decontamination solution tank – This tank holds sodium nitrate solution. A pump circulates solution through a filter where a flow-controlled side-stream is diverted into the decontamination fixture.
- Rinse water tank – This tank holds rinse water that is circulated through the fixture. A single pump is used to circulate both decontamination and rinse solutions.
- Air purge system – Dry compressed air will be used to purge the decontamination solution tank. Compressed air will also be used to clear the lines after decontamination and after rinsing.

Processing sequence:

- An oralloy part will be wiped with nylon rags to remove surface contamination.
- The oralloy part will be placed in the decontamination fixture.
- Sodium nitrate solution (200 g/L - 1.6 lb gal.) will be pumped through the fixture as the power supply is turned on to start electrolysis. The decontamination step takes five minutes.
- The fixture will be emptied by blowing through the lines with compressed air. The fixture rotates to allow draining all the decontamination solution.
- The fixture will be rinsed, and the rinse solution cleared with compressed air.
- The fixture will be opened, and the part removed and dried with nylon rags.
- Direct count instrumentation will be used to measure if the surface has <20 dpm/cm². If the part meets this specification, it will be placed in a plastic bag and sent to vault storage. If it has a high count, it will be processed through the electrolytic decontamination step once again.

Utility and Service Requirements

Waste treatment systems will be developed for the following wastes:

- Electrolyte solids – The electrolyte solution will periodically build up solids that will be decanted and removed from the decontamination tank. These will be filtered, dried, and packaged as waste.
- Rinse water – Rinse water will be evaporated or solidified and disposed as waste.

Direct current power supply of 20 Vdc, 50 A. This controls the electrodes at 3 Vdc and 30 A. It is located outside of the glove box.

5.3.7.2 HEU Vault

Functional/Operational Requirements

The HEU vault will have storage capacity for six month's operation.

HEU will be classified shapes stored in plastic bags.

The vault will be built to meet the requirements of DOE physical protection orders.

Procedures will be in place to periodically verify that unauthorized or unreported changes in inventory have not occurred.

Compartmentalization will be designed to limit the spread of contamination in the event of an accident and control access to SNM.

In-place material monitoring and inventory capability will be as required by DOE Order 5633.3B.

Items will be physically separated to prevent criticality.

A detection system will warn of unauthorized access to SNM.

Structural/Architectural Requirements

The vault walls and roof shall be reinforced concrete, capable of retaining structural integrity during and after DBAs and meeting physical security access delay requirements.

The required openings for air flow shall meet the requirements of DOE 5632.1C. The arrangement of the storage compartments, combined with the fixture holding and the location of stored materials within the compartments, shall be designed to assure criticality safe configurations.

The storage compartments shall be designed to retain structural integrity and desired configuration throughout the projected useful life of the facility, including during and after DBAs.

Fire Protection – There is no requirement for fire protection in the vault. Combustibles will not be permitted, and fire protection in this area is to consist of only manual extinguishers designed for electrical equipment fires.

5.3.7.3 HEU Shipping

Functional/Operational Requirements

HEU classified shapes will be loaded into DT-22 shipping containers—two hemispheres maximum per shipping container.

The shipping containers will be loaded onto SSTs for transport.

The HEU loading and shipping activity can use the same equipment and space as pit receiving.

5.3.8 Declassification Processing

Non-SNM metals will be crushed and melted in furnaces. These metals include stainless steel, aluminum, beryllium, and depleted uranium.

Functional/Operational Requirements

Approximately eight furnaces will be used to declassify non-SNM metals. Each furnace will usually be used for a specific type of metal.

Resistive heaters may be used, but induction furnaces have the advantage of heating and melting the metal faster.

Beryllium pieces may be decontaminated before melting, and the PDCF should provide for this contingency.

Non-SNM metals can be accumulated and melted together. Not all furnaces will be operating at once. Melted metals will be packaged and sent to the waste management area.

Utility and Service Requirements

Induction furnaces each require a 25 kW power supply/frequency controller. These are fairly large, 0.6 m wide x 0.9 m deep x 2.1 m high, (2 ft wide x 3 ft deep x 7 ft high) or larger. There will be a capacitor bank of similar size for each power supply. This equipment can be located in a utility room adjacent to or below the processing room. Switching may be utilized to allow more than one furnace to operate from one power supply.

The induction furnace coil is cooled by a limited-volume chilled water system.

5.3.9 Waste Management

Functional/Operational Requirements

All generated wastes and residues shall be processed for final disposal.

TRU wastes will be shipped to a DOE-approved facility.

LLW shall be immobilized and disposed of at a DOE-approved disposal facility.

Solid Waste Handling

The function of solid waste handling shall be to collect and dispose of all solid waste generated at the site. It shall perform the following functions:

- Collect and segregate solid waste into TRU waste, LLW, mixed-TRU waste, mixed LLW, hazardous waste, and nonhazardous waste.
- Compact or process the waste, as required, and package it for further processing or disposal.
- Assay and certify solid waste.
- Provide a waste storage area to stage a 90-day capacity of TRU waste, LLW, mixed-TRU waste, and hazardous waste. Provide 5-year storage capacity for mixed LLW pending on-site or off-site treatment and disposal.

5.3.10 Analytical Lab

Functional/Operational Requirements

Analytical services shall provide laboratories to perform chemical and nuclear analysis necessary to support operation of the facility.

The analytical laboratory will include glove box space for sample preparation. A 5–10 g (0.01-0.02 lb) sample of metal oxide from each batch to be sampled will be sufficient for all required analyses.

Analytical processes will be selected to minimize sample size and waste generation.

Following is a list of probable analyses that will be done in the analytical lab. The complete analysis list will depend on MOX acceptance criteria that are not fully defined.

Analysis	Possible analytical equipment or technique
Isotopic analysis	
Trace element analyses. This includes gallium.	Inductively coupled plasma (ICP) mass spectrometer
Surface area of oxide measurement	Brunauer-Emmett-Teller (BET) Method
Oxide particle size measurement	Laser scattering
Oxide particle characteristics	Scanning electron microscope (SEM)
Carbon and nitrogen measurement	Leco
Plutonium/oxygen ratio in the oxide	Modified Lyons method
Halide analysis	
Bulk or tap density	

Analytical laboratory support

The lab will be staffed by two analytical chemists and two technicians.

Analytical laboratory data-handling computers will support analytical laboratory sample tracking, data acquisition, analysis, reporting, data storage, QA, and laboratory management activities.

The laboratory will include the capability of evaporating or solidifying any liquid radioactive or liquid mixed waste generated as part of the laboratory operation.

5.3.11 Control Room

Functional/Operational Requirements

Equipment in the control room will provide for monitoring of facility conditions and facility and process systems as well as on-site and off-site communications.

The control room shall provide space for desks, classified file cabinets, video monitors, security equipment, CCTV, and communication equipment. The control room shall have provisions for monitoring classified data.

The control room must be habitable following an emergency. Primary and backup means of communications shall be available and capable of operating with other DOE elements, and with other federal, state, tribal, and local response organizations.

Heating, cooling, ventilating, and air cleaning with filtration for the control room shall be designed to provide habitability following an emergency. This function shall be designed to maintain a positive pressure in the center to enhance cleanliness and safety and to provide the proper environment for personnel, as well as for the electronic equipment located in the center.

All equipment in the control room (including remote terminals, printers, and memory devices) shall be afforded physical security protection commensurate with the most highly classified material processed. Security controls to safeguard the physical equipment apply not only to the computer equipment and its terminals, but also to all removable input or output media (e.g., magnetic tapes, magnetic disk packs, or optical storage media).

5.3.12 Change Room

Functional/Operational Requirements

A change room shall be centrally located next to the main personnel portal, waste management, and analytical services so that personnel can change into and out of protective garments when entering or leaving these areas. Personnel circulation within waste management and analytical laboratory areas shall be segregated from other nonrelated support area operations to limit personnel exposure to hazardous materials.

5.3.13 Offices and Related Facilities

Functional/Operational Requirements

Sufficient restrooms, lunchroom facilities, and lockers shall be provided for personnel.

Personnel decontamination showers, eyewashes, and safety showers shall be provided.

Office and workstation space shall be provided for radiation monitoring and operations, and shift support supervision. Plant engineering and other office requirements shall be determined during the conceptual design phase.

5.4 Management and Information Systems

Management of information shall include all computer-based data systems not covered by other facility systems. Because of security considerations, management of information is divided into classified and unclassified portions. Classified matter shall be handled in accordance with DOE orders. The information system shall include custom operational software.

Management of information shall provide:

- database management,
- distributed control system (DCS) support, and
- interface functions.

MC&A Data Handling

MC&A data handling contains the custom software required to perform the safeguard functions defined in DOE Order 5633.3B. The MC&A computer system shall interface with NDA instruments and other computer systems.

The MC&A computer will support data acquisition, data tracking, data storage, and reporting for MC&A activities. It shall provide instantaneous (real-time) status of all stored material, and be capable of handling both classified and unclassified data and shall include sufficient safeguards to prohibit the inadvertent commingling of classified data with unclassified data.

The MC&A computer shall include the capability to interface with continuous inventory-monitoring systems and/or the capability to interface with machine-readable labels for item identification. It shall be capable of assessing MC&A data, as required, from remote locations such as the material handling area.

The MC&A computer system shall protect access by use of keylocks, passwords, and other security capabilities deemed necessary to limit access to MC&A data. It shall include the capability for timed backup of systems data, as well as manual backup upon request.

The system shall have the capability of performing self-diagnostics. The system shall be provided with redundant power systems and shall be provided with the capability for automatic system recovery following a power failure. A system availability of at least 99% is expected.

The IAEA vault and other areas where the IAEA has access will have no link to the classified MC&A system; however, a MC&A system must support the needs of the IAEA.

5.5 External Drivers

Regulations, DOE orders, and select standards and guidance applicable to the PDCF are listed in Appendix A. The impacts of these requirements have been addressed in the scoping, preconceptual, and conceptual design efforts leading to this document.

Standard building and construction codes are not included in the table because those are inferred by DOE orders and may vary with site selection. The PDCF will meet the standard construction and life-safety codes and standards.

6.0 DESIGN CONCEPT

This section defines the equipment and facilities that respond to the functional requirements and that were used for preparing the cost estimates. The Pantex Plant is used as the reference site for conceptual layout of the PDCF and development of costs.

The facility elements are divided into two groups: (1) primary process functions defined as the primary/essential elements of the ARIES process and the associated process-support functions, and (2) facility systems/elements.

6.1. Project Design Description

The general layout of the processing area is illustrated in drawings titled Architectural Floor Plan First Floor Level (A01), and Basement Level (A02) (included Appendix B). These drawings show the PDCF material handling/process areas. Operations are compartmentalized into rooms so that in the unlikely event of contamination occurring in one area, operations can continue in adjacent areas. Rooms are arranged to provide for efficient and logical movement of material as plutonium is processed and prepared for storage in the IAEA vault. Certain operational rooms are designed as vault-type rooms that can function as in-process SNM storage vaults during maintenance shutdown.

The material handling system will include proven remote/robotic technology to limit personnel radiation exposure levels to ALARA. Movement of material containers in most areas is accomplished using automated guided vehicles (AGVs) via dedicated AGV aisles. Separate personnel corridors are provided to reduce worker radiation exposure, to eliminate a potential AGV accident, and to minimize personnel access to SNM.

Although the operating areas are designed to be normally free of contamination, contamination incidents must be considered. Therefore, the facility is designed to facilitate decontamination and confinement of plutonium and tritium. The pit container, which is packaged at the donor site, is a robust container. Under normal circumstances, material is confined within the container from the time it arrives at the facility until the pit is disassembled in a glove box and converted to oxide. After conversion, plutonium remains within glove boxes until its placement into welded inner containers. The facility design incorporates safety systems and features necessary to protect workers, the public, and the environment from consequences of potential accident conditions. Mitigating engineering features are included for most postulated accidents.

The primary functions accomplished within the PDCF are shown on drawings M201 and M202 in Appendix B. The material is moved between the operational areas within an enclosed conveyor system. The system operational areas listed below follow the order of flow of material through the plant.

- SST/truck bay
- Empty shipping package and CRT storage
- Loading/unloading dock/CRT handling
- Material confirmation
- Receiving vaults (staging)
- Unpackaging/packaging
- Bisector module
- Special recovery line
- Metal declassification
- HYDOX module and gallium removal
- Product packaging
- Product CRT assembly/loading dock
- Product vault
- HEU processing /packaging
- IAEA vault
- IAEA NDA
- Satellite waste collection
- Waste management
- Analytical services
- AGV maintenance

- Primary canning and decontamination
- Secondary canning
- Product NDA
- Equipment decontamination and maintenance
- Personnel decontamination

6.1.1 Process and Process Support Design Descriptions

6.1.1.1 SST/Truck Bay

Space The SST/truck bay is weather-protected and sized to receive one SST. The SST forms part of the secure facility boundary when it is in place.

Equipment A forklift is used to unload the SST.

6.1.1.2 Empty Shipping Package and CRT Staging

Space This area is located outside the MAA adjacent to the SST/truck bay. This area provides space to store empty shipping packages and disassemble CRTs. The area is sized to accommodate the number of empty shipping packages equivalent to the capacity of one SST.

Equipment Empty shipping packages are moved from the CRT assembly/disassembly area into the staging area by passing through a californium shuffler. This detects plutonium and/or uranium to ensure that empty packages are really empty. Shipping packages are stacked using a manual drum handler. A commercial manual pallet handler is used for stacking CRTs in the staging area.

6.1.1.3 Loading/Unloading Dock and CRT Assembly/Disassembly

Space The CRT-handling area includes an area sufficient to handle the capacity of one SST and a staging area for one empty CRT and four associated shipping packages.

Equipment The CRTs are removed from the SST and transported by a manually operated shielded forklift to the dock where shipping/receiving documentation is verified.

The CRT handling area is equipped with a jib crane for the assembly and disassembly of the CRTs.

A station will be available where all shipping packages are smear-tested before being moved by a conveyor to the next operation.

The use of proven automated material handling equipment is maximized to limit radiation exposure levels to ALARA.

All empty shipping packages returned to this area from the unpackaging/packaging area for staging outside the MAA are inspected in a californium shuffler to confirm the packages are free of SNM.

Health physics operations are performed to ensure that all material to be

removed from the SST is free of contamination before its removal.

6.1.1.4 Material Confirmation

- Space** The material confirmation area is where shipping measurements are confirmed for each shipping package. The reference shipping container is the FL.
- Equipment** A jib crane places the shipping package on a conveyor in the CRT-handling area for transfer to the material confirmation area. Equipment in the material confirmation area determines gamma and neutron fingerprints and the gross weight of the shipping package to confirm the shipper's information.

6.1.1.5 Receiving Vaults (Staging)

- Space** The vaults are located at two floor levels. The primary function of the staging vaults is to provide lag storage for shipping packages (FLs for pits and DT-22s for HEU classified components) and pit inner containers. The DT-22 shipping packages are used for shipping HEU classified parts

The first floor vault is sized to stage 100 FLs, 50 DT-22s, and 10 pit inner containers. The basement vault can accommodate a one-year supply of pit and plutonium metal as feed and HEU produced over six months of operations.

- Equipment** The packages are moved in and out of the vaults by remotely operated AGVs. Shipping package transfer to the basement level vault is performed with an elevator located next to the material confirmation area on the first floor. Appropriate criticality spacing is maintained by a fixed-type storage rack system.

6.1.1.6 Unpackaging/Packaging

- Space** The 260 m² (2800 ft²). unpackaging area is below the receiving area.

- Equipment** Shipping packages are transferred from the material confirmation area to the unpackaging/packaging area in the basement using the horizontal conveyor system, the AGVs, and the elevator. The unpackaging/packaging area is designed to disassemble a bolted shipping package using a track robot. The typical unpackaging operation is performed under a hood and consists of performing a gas sniff test on the shipping package internals, removing the lid from the shipping package, removing the inner container, smear testing the inner vessel, and removing the pit from the inner container.

All functions are performed remotely to limit personnel radiation exposure levels to ALARA.

6.1.1.7 Conveyor System

- Equipment** The material from each glove box line is moved to an overhead, horizontal conveyor system by a vertical conveyor. The material is transferred to the next processing area by an overhead conveyor system and lowered to the glove box

level by a vertical conveyor. The material transfer path from the vertical conveyor to the glove box is through an airlock system.

A motorized transfer cart system travels on tracks the entire length of the horizontal conveyor. The transfer cart carries a motorized carriage that transfers material from the horizontal conveyor into glove boxes through the airlock. The carriage travel path is at 90° to the transfer cart in the horizontal conveyor.

HVAC The conveyor system has an air atmosphere that is connected to the Zone 1 ventilation system.

6.1.1.8 Bisector Module

Space There are two pit bisection areas, each with 140 m² (1500 ft²) of floor space.

Glove boxes Pits are transferred to this area from the unpackaging/packaging area via a conveyor system consisting of both vertical and horizontal conveyors. Each area contains two glove boxes for bisecting pits into hemishells and one NDA glove box for performing accountability measurement on pit parts. The three glove boxes in each bisection area are arranged in series with an airlock system isolating the vertical conveyor from the glove box.

All glove boxes will be argon purged.

Glove box Equipment Each bisector glove box will contain one pit bisecting machine and mechanical equipment for de-nesting pit hemispheres.

6.1.1.9 Special Recovery Line

Space The SRL is in four rooms with a combined total of 285 m² (3050 ft²) of floor space.

Glove boxes The SRL area uses three lines of inert glove boxes with each line composed of four glove boxes. The glove box arrangement is shown on the drawing M201. All glove boxes will be argon purged.

Glove box Equipment Each line of gloveboxes will include a pit bisecting machine, a robotic apparatus for separation of hemisphere parts, vacuum furnaces, and tritium recovery equipment.

HVAC The SRL room has a HVAC system that can be isolated from the balance of the plant in the event of a tritium leak. If a tritium leak occurs, the SRL room is isolated and air in the SRL room is automatically directed through a tritium getter system before it is exhausted to the building HVAC system.

6.1.1.10 Metal Declassification

Space The 140 m² (1500 ft²) metal declassification area is located adjacent to the SRL.

Glove boxes The declassification area is equipped with two lines of glove boxes, each containing two argon-filled glove boxes. Non-SNM classified shapes are moved into the declassification furnaces from glove boxes in the SRL, the bisector area,

and HYDOX module.

Glove box Equipment One hydraulic press will be used to crush metal pieces. Eight furnaces will be used to melt metal pieces. The classified non-SNM material is declassified by casting it into an ingot, placed in a waste container, and moved to the waste NDA room located next to the HEU processing/packaging area.

6.1.1.11 HYDOX Module and Gallium Removal

Space There are two independent 360 m² (3900 ft²) areas provided for the HYDOX and gallium removal modules.

Glove boxes Each area contains two vertical conveyors, eight glove boxes, and a horizontal conveyor at glove box elevation. There are four glove boxes on each side of the horizontal conveyor.

Glove box Equipment Drawing M202 identifies the HYDOX modules and gallium removal modules. Each of these modules includes an oxide removal system.

The HYDOX glove boxes are provided with reagent-quality hydrogen, nitrogen, oxygen, and helium. A dedicated vacuum system is provided for the HYDOX reactors. The gallium removal glove boxes are provided with hydrogen, nitrogen, and argon.

6.1.1.12 Primary Canning and Decontamination

Space The 195 m² (2100 ft²) primary canning room contains a sample preparation module (for IAEA sampling), a primary canning module, and an electrolytic decontamination module.

Glove boxes Two glove boxes in this area receive material in convenience cans via the conveyor system. The operations performed these glove boxes involve placement of convenience cans in the inner container, welding, leak checking, and inner can electrolytic decontamination. The third glove box is used for sample management.

Glove box Equipment The primary canning module includes a welding station and a leak-check station. The electrolytic decontamination module contains a cleaning fixture and associated electrolytic decontamination solution preparation, circulation, and storage equipment. The glove boxes are provided with process vacuum service, clean dried air, argon, and helium to support canning and decontamination operations.

6.1.1.13 Secondary Canning

Space This 195 m² (2100 ft²) room contains two secondary canning stations and two laser marking stations.

Glove boxes The canning and laser marking do not require Zone 1 glove boxes, but shielding and material conveyors will be required to minimize exposure.

Glove box Each secondary canning module includes a welding station and a leak-check

Equipment station.

Laser marking machines will be remotely operated.

Shielding and transfer – Operations such as laser marking, final canning, and leak checking are shielded and kept far apart from each other to reduce worker exposure to radiation. Robotic material transfer is not included in the cost estimate, but some robotics may be required to meet ALARA requirements.

6.1.1.14 Product NDA

Space Welded product cans are conveyed to the 185 m² (2000 ft²) product NDA room.

Equipment Accountability measurements are performed on outgoing product cans. The conveyor system transfers a single can from the final canning area to the accountability measurement area. The accountability measurements are performed using calorimeters, gamma-ray isotopic instruments, a neutron coincidence counter, and weight scales. A robotic crane is used to place cans in the accountability measurement equipment. A shielded area is provided to stage 12 cans and store calibration standards. It enables personnel to enter the area without removal of the staged items. After the completion of accountability measurements, cans are loaded into a special pallet that holds four product containers. The pallets are moved from the product NDA area to the product vault located east of the equipment corridor with the AGV.

6.1.1.15 Product Packaging

Space The cans are prepared for shipment in the 120 m² (1300 ft²) unpackaging/packaging area located at the south end of the PDCF.

Equipment Leak check station – The can is leak checked and smear tested before placing it inside the screw-top 2R container. The 2R container is placed inside the secondary container, and the secondary container is placed inside the shipping package, which has a bolted top. A final smear test is performed on the shipping package before sending it to the material confirmation area.

Material confirmation station – A neutron and gamma fingerprint of the shipping package is taken in the material confirmation area as required by DOE Order 5633.3B.

6.1.1.16 Product CRT Assembly/Loading Dock

Space A shipping package ready for shipment is moved from the unpackaging/packaging area to the CRT assembly/disassembly area located in the southeast corner of the facility.

Equipment CRT loading – Each CRT is assembled by using a jib crane.

Assembled CRTs are moved by elevator and shielded forklift to the SST loading dock located on the first floor. Using a shielded forklift, the CRTs are loaded into SSTs.

6.1.1.17 Product Vault

- Space** The 70 m² (750 ft²) product vault is capable of storing/staging 250 cans and also satisfies the surveillance and inspection requirements for long-term storage.
- Equipment** The oxide cans are loaded onto a special pallet in the product NDA area. Each pallet holds four cans with spacing to prevent criticality. The pallet is moved by an AGV to a receiving station located in the product vault gallery. From here, the pallet is moved by a telescopic AGV to the product vault. The product vault is equipped with a warehouse-type rack system.

6.1.1.18 HEU Processing/Packaging

- Space** HEU pieces are conveyed to the 225 m² (2400 ft²) HEU processing/packaging area.
- Glove box** There are two glove boxes directly connected to the conveyor system. Material is moved manually from one glove box to the next. The operations performed in this area consist of accountability measurements, removal of plutonium contamination, and packaging. The classified HEU shapes are packaged in DT-22 shipping packages and moved to the receiving vault or to the CRT assembly/disassembly area in preparation for shipment.
- Equipment** One glove box contains an electrolytic decontamination fixture and solution transfer system.
- The processing glove box receives process vacuum service and clean dry air to support decontamination operations.

6.1.1.19 IAEA Vault

- Space** The 160 m² (1700 ft²) IAEA vault is located in the unclassified section of the facility and uses the same storage concept as the product vault. The IAEA vault is capable of storing/staging 2000 cans.
- Equipment** Cans are transferred from the product vault to the IAEA vault through a material transfer portal. Two dedicated AGVs are provided on each side of the transfer portal. The transfer is made in the presence of and verified by IAEA inspectors.
- A can selected for destructive assay sampling is transferred to a receiving station located in the IAEA vault gallery. The can is moved by a shielded cart to a sample management glove box located in the primary canning area. After sampling, the can undergoes primary and secondary canning operations, before its placement back in the IAEA vault.

6.1.1.20 IAEA/NDA

- Space** The 65 m² (700 ft²) area designated for the IAEA is used by IAEA personnel to inspect and verify SNM. International inspection activities also include the review of records and information recorded from instrumentation and CCTV cameras provided by the inspection agency.
- Equipment** Equipment located inside the international inspection area is provided by the inspection agency and is operated by the PDCF operators.

6.1.1.21 Satellite Waste Collection

- Space** Process wastes are sent to the 45 m² (500 ft²). satellite waste collection room.
- Equipment** The majority of the waste generated by the PDCF is recyclable nonradiological waste. However, glove box operations will generate TRU and TRU mixed waste and items such as used gloves and wipes, which are LLW. Waste in the MAA is segregated and collected in pails, drums, and boxes near the waste generator. When sufficient quantities of waste are collected, the waste is moved from these areas with an AGV or a manual cart to the satellite waste collection area. NDA equipment is located in an adjacent room to perform accountability measurements on the waste. Waste is transferred from the MAA to the waste management area for packaging and certification via the waste drum portal. At this portal all waste is assayed for SNM in a californium shuffler to prevent inadvertent removal of SNM from the MAA. No major equipment is required in the satellite waste collection area.

6.1.1.22 Waste Management

- Space** Waste from the MAA and noncontrolled areas of the facility are brought to the 290 m² (3150 ft²) waste management area for staging, treatment, and disposal. Waste is segregated and collected as TRU waste, LLW, mixed-TRU waste, mixed LLW, hazardous waste, and nonhazardous waste.
- Equipment** Assay and packaging equipment – Nonhazardous waste is assayed, packaged and, transferred off-site for disposal. Hazardous waste is analyzed, packaged, solidified if liquid, and transferred off-site for treatment and disposal. Mixed LLW and mixed-TRU waste are size reduced or solidified if liquid. Mixed LLW is packaged and assayed for interim storage followed by transfer off-site for treatment and disposal. Mixed-TRU and TRU waste is packaged and assayed for transfer off-site for disposal at WIPP. LLW and TRU waste are sized reduced or solidified, if liquid. LLW is packaged and assayed, and transferred off-site for disposal. Major waste management equipment items are contained within glove boxes. Operations performed within glove boxes include sorting, size reduction, liquid solidification (evaporate, adsorb, and/or solidify), and waste packaging.

6.1.1.23 Analytical Services

- Space** The 460 m² (4950 ft²) analytical lab will analyze metal, oxide, and waste samples from the PDCF processing area.
- Equipment** Analytical services support all facility operations. This includes support of numerous at-line analytical functions, such as NDA for plutonium accountability in the MAA and characterization of waste accumulated in the satellite waste collection area. Analyses are performed in the waste NDA laboratory using a low-level drum gamma system and segmented gamma scanners to survey drums and pails. Because most of the analytical tests and measurements involve small quantities of SNM, most of the analytical laboratory functions are performed outside the MAA in the laboratory. Several types of analysis activities are provided: plutonium isotopic analysis, oxide characteristics, NDA waste characterization, trace element analysis, residue accumulation analysis, organics analysis, analytical laboratory support, and laboratory sample receiving.

6.1.1.24 AGV Maintenance

- Space** Maintenance areas are provided for major robotic, delivery, and mechanical equipment.
- Equipment** AGVs are used extensively and require regularly scheduled maintenance. The AGV maintenance area provides space for the servicing and maintenance of the AGVs within the MAA. The area houses an AGV maintenance shop equipped with a hydraulic lift, electronic/electrical repair equipment, and standard shop tools. The AGV maintenance shop has AGV battery-charging stations and space for a test track that can be used to facilitate AGV repairs. Space is provided in this area for storage of a spare AGV and its associated battery-charging station.

6.1.1.25 Equipment Decontamination and Maintenance

- Space** The PDCF is designed as a low-maintenance facility that will not normally encounter contamination. However, during the anticipated 10-year life of the mission, it can be expected that maintenance of contaminated equipment may be required. Because it is difficult to transfer contaminated equipment outside the MAA for maintenance, a contaminated equipment maintenance area is provided inside the MAA.
- Equipment** Equipment and tools requiring maintenance are decontaminated in place (wiped), if possible. If they cannot be decontaminated in place, they are overpacked and moved to the decontamination area for further decontamination. After decontamination, equipment is moved to the contaminated equipment maintenance area. This area is equipped with an overhead crane and standard shop equipment. A surface finish of special protective coating is provided in the locations where equipment maintenance takes place to facilitate localized decontamination, should it be required. Items requiring maintenance are delivered to this area by forklift or by AGV. Contaminated liquid waste produced in this area is collected and transferred to the waste management area for treatment.

6.1.1.26 Personnel Decontamination

Space	There are five personnel decontamination areas provided.
Equipment	The areas are equipped with personnel showers and radiation monitors. Decontamination areas are accessible from the primary canning area, packaging area, unpackaging area, equipment decontamination and maintenance area near the personnel elevator MAA entry.

6.1.2 Facility Systems/Elements

6.1.2.1 Site Development

For the reference site, the process facility is located within an existing perimeter intrusion detection and assessment system (PIDAS). Most support facilities is located outside the PIDAS adjacent to the process facility to reduce the level of activity within the PIDAS. The project area covers approximately 20 ha (50 acres).

Site Preparation

The reference site area requires removal of 380 m³ (500 yd³) of clean rubble consisting of clean soil, broken concrete, and reinforcing steel. In addition, a portion of an existing railroad and bisecting road will be removed.

The new facilities within the PIDAS include the following:

- process facility,
- source calibration facility,
- emergency generator building,
- unit substation building,
- effluent monitoring system/meteorological towers,
- liquefied gas supply area, and
- service roads and pedestrian access.

The remaining support facilities will be constructed outside the PIDAS. It is anticipated that this area is clean and does not contain any hazards. The facilities outside the PIDAS include the following:

- electrical switch yard,
- fire water storage tank and pump house,
- cooling tower,
- standby generator,
- diesel fuel storage,
- utility building,
- waste storage area,
- parking,
- perimeter service and support roads,
- protected area vehicle entry portal,
- protected area personnel entry portal,
- protected area SST entry portal, and
- construction laydown area/support facilities.

Site Grading and Storm Water Management

New facilities are planned to fit the current topography with a minimum amount of grading. Measures are taken to control erosion and minimize sediment transfer. All facilities and buildings should preferably be located above the critical flood elevation (CFE) for potential flood sources or be hardened to mitigate the effects of the flood source so that performance goals are satisfied.

Site drainage will comply with the regulations of the governing local agency. The minimum design level for the storm water management system is 25-yr, 6-h storm, but potential effects of larger storms up to the 100-yr, 6-h storm will also be considered.

Facilities in performance categories above Performance Category 1 (PC-1) will be constructed with the lowest floor of the structure above the level of the 500-yr flood. This requirement can be met by siting and flood protection. When possible, all facilities, including their basements, in all performance categories will be sited above the 100-yr floodplain.

There are storm water ponds at the reference site that could be used for storm water management to support the PDCF project.

Utilities

Electrical power, potable water, fire water, sanitary wastewater, natural gas, utility wastewater, plant and instrument air, chilled water, steam, and natural gas are required utility services at the process facility.

New utility facilities are located west of the process facility outside the PIDAS. Utility service lines are routed from these new utility facilities to the process facility. When appropriate, utility services are installed below grade. Piped utilities are protected against freezing and corrosion.

Potable and sanitary wastewater systems comply with the requirements of the Uniform Plumbing Code and the American Society of Civil Engineers (ASCE)-37. There are no interconnections between storm water systems, sanitary waste systems, and radioactive or other hazardous material handling systems. The PDCF is serviced by the existing sanitary/wastewater treatment system. Existing plant and potable water supply is available at the site. A new fire water storage tank and pumping facility is required to augment the existing fire water system at the site. A new central chilled water system is supported by a new cooling tower facility.

A new electrical switchyard is required to supply electrical power to support the project. Power is routed from the switchyard to the process facility via electrical ducts. Emergency generators are located within the PIDAS to provide backup power to critical services and lighting.

Natural gas is also available at the site to support the project and is extended to the facility. For the reference site, steam is provided to the PDCF from the existing boiler. A new plant and instrument air system is located in the new utility building.

Environmental Considerations

The storage tanks meet state and federal environmental requirements. Secondary containment is provided in the event of an oil spill from the transformers and from the diesel fuel in the generators (refer to 40 CFR 112).

Paving and Surfacing

All vehicle circulation facilities (roads, streets, access drives, and turnaround areas) are paved and comply with standards for geometric design of highways and streets, AASHTO GDHS-90. Vehicle circulation facilities are located to avoid interference with the PIDAS.

Physical Protection and Security

Clearly defined physical barriers, such as fences, walls, and vehicle barricades are used to control, impede, or deny access to the nuclear materials and sensitive information. Fencing is limited to that required for safety, physical security, and activity control. Fencing is grounded around substations, fuel storage areas, and other hazardous areas.

All pedestrian and vehicular traffic access to the process facility is controlled through new or upgraded entry portals through the PIDAS.

Construction

A temporary PIDAS is required to segregate the process facility construction activities from the rest of the protected area.

Temporary construction facilities areas are necessary outside the PIDAS to support construction. The construction facilities include construction laydown, storage and warehousing, parking for construction personnel, and roads for construction deliveries and traffic.

6.1.2.2 Architectural Development

Building Description

The PDCF is a safety class structure for handling of plutonium. All of the systems required to reconfigure plutonium pits into oxide or other nonweapon shapes and to package the material for disposition are contained within a hardened concrete structure. The plutonium-handling activities are located on the main level, which is below grade, with ancillary support on the level above, which is at grade. Activities needed to support the plutonium reconfiguration are either housed in spaces adjacent to the main hardened building or housed elsewhere on the site.

The process area is located on single floor level, below grade, with a wall and portals separating controlled and uncontrolled areas as shown on drawing A02. The total square footage of the floor is approximately 7150 m² (77 000 ft²), including the controlled area at about 5200 m² (56 000 ft²) and the uncontrolled area at about 2040 m² (22 000 ft²).

The facility support areas are located on a floor above the process area at grade level and a single story connected building as shown on drawing A01. These areas occupy approximately 10 770 m² (116 000 ft²). The area directly above the process area houses the mechanical and electrical equipment and occupies approximately 6600 m² (71 ,000 ft²). The office wing area is about 3250 m² (35 000 ft²).

The total building gross area is approximately 18 030 m² (194 000 ft²).

Code Basis

Construction type is Type I (all nonflammable materials) and the area separation between occupancies is 2-h construction in accordance with uniform building code (UBC); however, generator rooms are provided 2-h separation regardless of adjacent occupancy.

Code Compliance

Process areas are fully accessible and in compliance with ANSI Standard A117.1 and the Uniform Federal Accessibility Standard, 41 CFR 101-19.6.

Partitions are drywall type, fire rated in accordance with the UBC. Wall framing is minimum 24-gauge galvanized metal studs.

Occupied spaces are suitably lighted and ventilated for safe habitation at all times in accordance with the UBC.

Access and Egress

Access and egress complies with the NFPA-101, Life Safety Code.

Building Envelope

The roof system is rigid insulation and a single-ply membrane on the roof deck with galvanized metal flashing.

The building envelope is insulated and sealed sufficiently to allow maintaining an internal negative pressure.

Penetrations through fire-rated assemblies and at each floor of vertical pipe chases are sealed with a fire-rated material commensurate with the fire-rating of the wall.

Support structure exterior cladding and windows are designed to resist wind or missiles up to 31.2 m/s (70 mph).

Exterior doors are designed to meet security requirements and to protect against design-basis wind missiles.

Architectural Finishes

Process area floors, walls, equipment, and exposed structure are coated with decontaminable epoxy or lined with stainless steel where abrasion or impact dictates more robust finishes.

An access floor system with antistatic, high-pressure plastic laminate surface and grounding connectors over recessed slab is provided in the control room and with grated panels in rooms, where necessary, to contain possible contamination.

Plumbing

Floor sumps with drains are included throughout to collect sprinkler discharge and to contain contaminated effluent. A radioactive waste area is provide to collect and treat effluent waste as necessary. The collection system is designed to prevent a criticality accident.

Controlled restrooms are provided with radioactive waste collection and secure venting.

Radiation Control

Shielding is provided by solid, continuous concrete walls, floors, and roofs in vaults; however, in other areas as necessary, material is shielded by glove box walls, containers, or by shielding devices located within working areas.

Monitoring is provided at all transition zones and the personnel decontamination station at the main MAA entrance and exit.

Fire Protection

The building will be built to meet the fire protection requirements in DOE orders. Portable fire extinguishers are provided in accordance with NFPA 10.

Sprinkler systems are located in all areas of the facility, except storage vaults.

6.1.2.3 Structures

Description of Facilities

The main process portion of the PDCF is a two-story, heavy, reinforced concrete building. This building is characterized as a PC-4 facility, and as safety class. Seismic resistance is provided by shear walls. The roof and first floor are concrete slabs supported by concrete beams and columns. The first story is a basement and the foundation will be a base mat. Exterior walls will be a minimum of 20-cm (8-in.) thick above grade and 30-cm (12-in.) thick below grade. The pit vault, DT-22 vault, and IAEA vault have floor-to-floor concrete walls of 20 cm (8-in.) minimum thickness.

The analytical lab and the office (one story) are one building, seismically separated from the process building. The analytical laboratory and office building is a PC-2, essential occupancy, nonsafety class facility. The lab/office building is a steel-framed building with steel beams and columns. The roof is a steel deck with concrete fill. The second floor is a concrete slab. The first floor is a concrete slab on grade. Foundations are spread footings. The seismic resistance is provided by braced and/or movement-resisting frames. Exterior walls are insulated steel panels with windows as appropriate.

Structural Requirements

Design for the process building is in accordance with DOE orders, and applicable provisions of the UBC are used.

Design for NPHs, including wind and earthquakes, is in accordance with DOE-1020-94 for the process, laboratory, and office buildings. Supplemental site-specific NPH criteria will be incorporated as applicable.

For the process building, loads, load combinations, and design requirements are in accordance with ACI-349 (for concrete) and ANSI/AISC N690-1994 for steel structures (if any). Thermal loading shall be analyzed and included as applicable. Structural design of the process building to meet safeguard and security requirements is in accordance with applicable DOE standards.

For the lab and office building, steel construction conforms to the AISC Design Specifications and Manual of Steel Construction. Concrete design conforms to ACI-318.

Requirements for structural design of equipment foundations, supports, piping, ducts, conduits, architectural elements, and other nonstructural components are in accordance with applicable provisions cited above.

A geotechnical/foundation investigation will be required to supplement existing data to determine various foundation design parameters. Data required includes, but is not limited to, permissible soil bearing pressures for foundations, lateral soil pressures and distributions for below-grade walls, and various parameters needed to assess seismic effects including soil-structure interaction.

Seismic Design and Qualification of Systems and Components

Nonstructural systems and components of the facility (including process systems, support systems, and facility systems) require seismic design and qualification. Items requiring seismic design and qualification include: distribution systems, such as piping, conduit, ducting, and all related foundations, supports and bracings, mechanical and electrical equipment, supports, foundations and bracing, control systems, including computers, control panels, supports and bracing, and architectural elements, such as suspended ceilings, lighting panels, access floors, windows, wall panels, and related supports and bracing.

Items in PC-3 and PC-4 facilities are evaluated for a design basis earthquake. In PC-2 facilities, items are designed to enhanced UBC requirements.

Seismic design and qualification is to meet requirements of DOE standard 1020-94, as well as various appropriate nuclear and nonnuclear standards particular to each discipline. Seismic qualification to assure functionality of safety-related items is provided by analysis and design, testing, experience and historical data, judgment, and combinations thereof.

6.1.2.4 HVAC and Confinement Zones

The HVAC systems provide for proper environmental control for equipment protection and the health, safety, and comfort of the operating personnel. The HVAC system also functions to provide confinement ventilation that minimizes the spread of potentially radioactive airborne contaminants within the facility and limits releases to the environment within the ALARA guidelines.

The HVAC system consists of fans, filters, cooling and heating coils, and air distribution and exhaust ducting.

Codes and Standards

The design of the HVAC systems is per the following applicable design standards:

- ASHRAE,
- American Refrigeration Institute (ARI),
- National Electric Code (NEC),
- NFPA,
- American Society of Mechanical Engineers (ASME),
- ANSI,
- Sheetmetal and Conditioning Contractors National Association (SMACNA), and
- DOE orders.

Confinement

Confinement ventilation is achieved by directing the airflow from areas of low potential for contamination toward areas of high potential for radioactive contamination. This is controlled through pressure differentials between the confinement boundaries.

There are three basic ventilation zones for the facility and are described as follows:

Zone 1 areas are the glove boxes, fume hoods, and conveyor enclosures.

Zone 2 areas have the next-highest potential for contamination and these are the process rooms.

Zone 3 areas are the MAA corridors and other areas that support the process.

The following are the zone pressures that would support the confinement philosophy of flow from low to high potential for radioactive contamination;

Zone 1: (-) 1.77 cm (0.70 in.) water gauge (WG) with respect to the atmosphere

Zone 2: (-) 0.63 cm (0.25 in.) WG with respect to the atmosphere

Zone 3: (-) 0.38 cm (0.15 in.) WG with respect to the atmosphere

Results of the preliminary ventilation zoning analysis are reflected in the zoning drawings M105 and M106.

Airflow Rates

Airflow rates are calculated to satisfy two conditions: airflow required for cooling and airflow based on air change rates. Therefore, flow rates are established based on the criteria below.

Zone 1: 35–40 air changes per hour or as required for cooling; the higher of the two airflows will be used.

Zone 2: 10–12 air changes per hour or as required for cooling; the higher of the two airflows will be used.

Zone 3: 7–8 air changes per hour or as required for cooling; the higher of the two airflows will be used.

System Description

The HVAC system for the glove box and conveyor systems is shown on drawing M102. The HVAC system is comprised of two 100% capacity outdoor air-supply units. Air passes through a series of filtration systems and conditioned for supply to the conveyor and glove boxes. Effluent air passes through three HEPA filter stages and discharges to the Zone 1 exhaust stack. HEPA filters are provided between the process modules and the ventilation ducts to minimize contamination of the ducting system. Inserted glove boxes will have argon recirculation and makeup system with a HEPA-filtered exhaust connection to the Zone 1 exhaust system for negative pressurization.

The analytical laboratory, waste management areas, and the change rooms will have an independent HVAC system. The flow diagram of the HVAC system is shown on drawing M103. The system employs a once-through ventilation system with two 50% capacity supply air-handling units with HEPA filters and conditioning water coils. Air is supplied at ceiling level and exhausted at floor level through multiple exhaust points. Each floor exhaust is a box/plenum housing single-stage high-efficiency filters to prevent contamination of the ductwork. The room exhaust shall be filtered through two HEPA filter stages before discharge to the atmosphere. The glove boxes and fume hoods will have independent exhaust systems of two HEPA filter stages and fans, each discharging to the Zone 1 exhaust stack.

The MAA areas will have an independent supply for the Zone 3 areas, a cascade system of Zone 3 air supplied to Zone 2 areas, and an independent supply system for the SRL areas. The HVAC systems are shown on drawing M101. The Zone 3 supply system consists of high-efficiency filters, single-stage HEPA filters, conditioning coils, and fans. Zone 3 air is cascaded to the Zone 2 area via the Zone 2 transfer system that consists of two stages of HEPA filters and coils. The SRL supply system consists of high-efficiency filters, single-stage HEPA filters, and cooling/heating coils designed to condition 100% outdoor air supply to the SRL areas.

Room exhaust from the Zones 2 and 3 areas passes through two stages of HEPA filters and discharges to the Zones 2 & 3 exhaust stack. Exhaust from the SRL tritium getter and hood exhaust will pass through a minimum of three stages of HEPA filters and discharge to the Zone 1 exhaust stack.

Heating Hot Water

A steam-to-hot-water converter will provide heating water to the air conditioning system. Heating water shall be pumped to the hot water users through distribution piping with control valves and other accessories.

Controls and Monitors

The design of the HVAC control systems will include provisions for monitoring of pertinent operational data, such as flows, temperatures, and pressures. All exhaust stacks will be provided a redundant CAM system.

HEPA filtration systems will be provided with test sections and instrumented in accordance with the requirements of ASME AG-1.

HVAC System Interface

The HVAC system will interface with the following systems:

- Communications systems and exhaust monitoring
- Electrical systems to provide electrical power to the HVAC equipment
- Instrument/plant air systems to provide instrument air for the pneumatic control components
- Fire protection system to provide for fire detection and alarm
- Instrumentation systems to provide for the HVAC control and alarm systems wiring

6.1.2.5 Safety Support Systems

The conceptual design of the PDCF SSCs did not include a safety analysis in accordance with DOE Order 5480.23. The engineering estimate for Title I and Title II does consider this effort. However, in order to provide some guidance for the parametric capital cost estimate, potential safety-class systems and components are located in hardened concrete structures. Also, emergency generators have been included for critical loads associated with these systems and components. Typical potential safety-class items include HVAC, emergency power generators, vault storage racks, process glove boxes, nuclear incident monitors, UPS, and other safety-related instrumentation and alarms.

6.1.2.6 Utility and Process Support Systems

Argon Purification System

The purpose of the argon purification system is to limit the gaseous chemical contaminants in the glove boxes that operate under an argon atmosphere. Oxygen, nitrogen, and water vapor content are limited to <5 ppm.

The argon gas purification unit is a stand-alone self-contained system mounted beneath one of the glove boxes it services. Typically, a unit services three glove boxes. The purification units consist of a blower, catalytic oxygen removal unit, regenerable desiccant-type or molecular sieve water drier,

nitrogen removal unit, and a HEPA filter. The system includes pressure regulators, alarms, and distribution piping. The purification unit requires vacuum for desiccant drier regeneration, and regeneration gas (94% Ar, 6% H₂) for oxygen removal.

This system interfaces with the HVAC system and process vacuum system.

Bottled Gases System

The purpose of the bottled gases system is to provide small quantities of gases, such as helium, hydrogen, oxygen, chlorine, regeneration gas, and P-10 calibration gas to various users.

The compressed gas bottles are stored in mechanical equipment rooms outside the MAA, where practical. The system includes bottle racks, pressure regulators, alarms, and distribution piping to the applicable users.

This system interfaces with the plant and instrument air system and central alarm system.

CAM System

The CAM system provides microprocessor-based monitoring of alpha particles throughout the PDCF. The system uses CAMs installed throughout the facility wherever potentially airborne radioactive materials are present. Data communication paths for remote monitoring and alarming are provided.

Monitoring and alarming of airborne alpha contamination is accomplished with the CAM system and in-line samplers. A CAM head is provided at each HVAC exhaust register within the controlled area, and an additional two to four CAMs are provided in each room, depending on room size and activities within the room. The air is continuously monitored, CAM output is connected to the central monitoring system and to local readouts. Local readouts of the CAMs are provided at the entrance to each room so that current conditions in a room are known before entry into the room.

These vacuum systems operate continuously and loss of vacuum is alarmed through the central alarm system. In addition to CAMs in the controlled areas, 100% redundant isokinetic in-line sampling units are provided in the HVAC building exhaust stack.

Equipment provided in this system consists of piping, filters, vacuum blowers, samplers, and instrumentation.

The system interfaces with the HVAC system for off-gas exhaust, the electrical system, the central alarm system, compressed air system, and the HVAC chilled water system for cooling the blowers. The isokinetic units interface with the UPS system.

FAS System

The fixed head air sampling (FAS) system monitors the MAA for airborne alpha particles. The system uses FASs installed throughout the facility wherever potentially airborne radioactive materials are present.

Monitoring of airborne alpha contamination is accomplished with the FAS system. A FAS head is provided at each HVAC exhaust register within the controlled area, and an additional two to four FASs are provided in each room depending on room size and activities within the room. All FAS locations are easily accessible for calibration, filter changes, and source checks that are performed on a frequent basis.

This vacuum system operates continuously and loss of vacuum is alarmed through the central alarm system. Equipment provided in the system consists of piping, filters, vacuum blowers, samplers, and instrumentation.

The system interfaces with the HVAC system for off-gas exhaust, electrical system, central alarm system, compressed air system, and HVAC chilled water system for cooling the blowers.

HYDOX Reactor and Dry Vacuum Systems

The HYDOX reactor and dry vacuum systems provide high vacuum service specific to the HYDOX glove box operations and standard vacuum service to the facility for airlock evacuations, respectively.

The required vacuum system consists of a HEPA inlet filter, dry vacuum pumps, piping, and instrumentation.

This system interfaces with the HVAC and process chilled water systems.

Limited Volume Cooling Water System

The LV cooling water system provides a heat sink within a glove box. The cooling so provided is geometrically safe and minimizes the potential for the spread of contamination beyond the interior of the glove box.

The LV cooling water system consists of liquid-liquid heat exchanger to an external process chilled water source, a circulating pump, a small volume reservoir, and discharge filter, piping, and instrumentation.

The LV cooling water system interfaces with the process chilled water system.

Liquefied Argon System

The liquefied argon system meets the process requirements for liquid and gaseous argon.

The liquefied argon system consists of a truck unloading pad with argon metering instrumentation, a cryogenic storage vessel, argon vaporizer, point-of-use liquid argon metering system, controls, instrumentation, a jacketed vacuum-insulated liquid argon piping system, and gaseous argon distribution piping.

The liquefied argon system is independent of other systems.

Liquefied Nitrogen System

The LN system provides the process requirements for liquid and gaseous nitrogen.

The LN system consists of a truck unloading pad with nitrogen metering instrumentation, cryogenic storage vessel, nitrogen vaporizer, point-of-use LN metering system, controls, instrumentation, a jacketed vacuum-insulated liquid nitrogen piping system, and gaseous nitrogen distribution piping.

The LN system is independent of other systems.

Polished Deionized Water System

The purpose of this system is to produce polished deionized water (DIW) from deionized water and distribute it to users, as required.

The polished deionized water system is a package unit comprising mixed bed polishing tanks, filters, piping, instrumentation, and piping associated with distribution of deionized water to users. The unit is located outside the radiologically controlled area and piped to users. The portable remotely regenerative ion exchange cartridges are periodically exchanged.

The polished DIW system interfaces with the deionized water system.

Process Chilled Water System

The process chilled water system provides cooling water to those operations with the potential for radioactive contamination.

The process chilled water systems consist of a liquid-liquid heat exchanger, a process chilled water reservoir, two 100% circulating pumps, piping, controls, and instrumentation.

The process chilled water system interfaces with the plant water system, central chilled water systems, and the central control system.

Tritium Gettering/Removal System

The tritium getting and removal system prevents the release of tritium through the HVAC system.

The tritium getting system routes all exhaust ducting from special recovery line operations to a tritium removal system. The removal system consists of a catalytic reactor, molecular sieve beds, piping, and instrumentation.

The tritium getting and removal system interfaces with the HVAC system, the SRL operation glove boxes, the central alarm system, and waste management system.

Chilled Water System

The chilled water system is the central chilled water system that provides cooling services to the HVAC equipment and the process chilled water system.

The chilled water system is a closed-loop recirculating system that is composed of a packaged commercial chiller, chilled water expansion tank, circulation pumps, distribution piping, instrumentation, and controls. Make-up water to the chilled water system is provided from the DIW system. Refrigerant condensing is accomplished with cooling tower water.

The chilled water system interfaces with HVAC equipment, the DIW system, the process chilled water system, the cooling tower system, and the central control and alarm system.

The chillers and pumps will have sufficient redundancy/capacity to allow service and/or maintenance of this equipment without interruption of service operation.

Cooling Tower System

The cooling tower system supplies cooling to the chilled water system.

The cooling tower system consists of a cooling tower, tower basin, circulation pumps, pH adjustment system, multimedia filter beds for make-up water, a chemical injection package unit for corrosion inhibitor, controls, instrumentation, and distribution piping.

The cooling tower system interfaces with the chilled water system, sulfuric acid receiving and storage system, sanitary wastewater system, and the central control and alarm system.

Emergency/Standby Power Generation System

The emergency/standby power generation system provides independent emergency or standby power to the facility. The fuel storage portion of the emergency system provides diesel fuel to the emergency generator day tank. The fuel storage portion of the standby system provides the ability to transfer backup fuel to the natural gas-fired steam boiler, transfer fuel to the diesel-driven fire water pump, and provide fuel to the standby power generator day tank.

The emergency/standby power generation system fuel supply consists of two independent fuel delivery systems with metering stations, diesel storage tanks, diesel fuel distribution pumps, filters, controls, and instrumentation. Diesel-driven emergency and backup power generation units are package units, consisting of a diesel engine, generator, day tank, controls, and instrumentation.

The emergency/standby power generation system interfaces with emergency power users, such as the central control and alarm system and monitoring systems. The standby system interfaces HVAC equipment and the chilled water system.

Fire Water System

The fire water system provides a source of fire water to protect buildings and facilities.

The fire water system consists of fire water storage tank, fire water pumps, hydrants, monitors, and an underground piping loop. One electrically driven fire pump and a diesel-driven fire pump are used to supply fire water. A jockey pump is provided to maintain piping loop pressure. Make-up water and initial fill of the fire water storage tank is from the plant water system.

The fire water system interfaces with the central control and alarm system.

Plant and Instrument Air System

The plant and instrument air system provides general-use plant air and specification instrument air to users at the PDCF.

The plant and instrument air system consist of single-stage compressors and an air purification system. One compressor was chosen to supply the required volume of air; a second machine of identical capacity is the spare. The compressors are included in package units that include aftercoolers.

The air purification system consists of regenerative air dryers, particulate filters, and air receivers. These components are also specified as a package system. The compressed air system is split into an instrument air supply and a plant air supply. The plant air supply is subjected to back pressure regulation, which shuts off plant air supply when system pressure falls.

Instrument air pressure is controlled by loading compressor suction valves. If instrument air supply pressure falls, pressure control instrumentation begins throttling the instrument air supplied to plant air users and supplying it to HVAC instrumentation on the highest priority.

The system includes two air receivers to provide operating flexibility and reliability and minimize space requirements. The receivers are each sized to provide a 3-minute surge capacity of instrument air in the event of compressor shutdown.

The plant and instrument air system is dependent on the chilled water system to provide jacket cooling and cooling water to the after coolers. The system also interfaces with the electrical system, central alarm system, and sanitary sewer system.

User interface conditions for compressed air pressure is 6.8 atm (100 psig) at 18° C (65° F), with a dew point of -40° C (-40° F). Air receiver vessels are each sized for a 3-min capacity.

Breathing Air System

The purpose of the breathing air system is to provide clean, properly humidified air for consumption by personnel while conducting decontamination or maintenance tasks.

To meet health requirements, compressed air meeting Compressed Gas Association Grade D breathing air specifications is supplied from tube trailers with backup bottled gas.

This system has no dependence on other systems.

Potable Water System

The purpose of the potable water system is to supply cold and hot potable water to users.

The existing potable water system is extended to the PDCF. This water line is split into hot and cold potable water distribution systems. Potable cold and hot water are provided to restrooms, change rooms, decontamination room, and janitors' fixtures. Potable cold water is provided to the DIW system. The supply of potable hot water is provided by local electric hot water heaters. All potable water fixtures are fitted with vacuum breakers.

Sulfuric Acid Receiving and Storage System

The sulfuric acid receiving and storage system provides for cooling tower water pH adjustment.

The sulfuric acid receiving and storage system consists of a truck unloading pad, truck unloading pump, diked sulfuric acid storage tank, metering pumps, piping, controls and instrumentation. The system is provided with a sulfuric acid area sump. The sump receives spilled acid from the truck unloading station, wash-down water from pad cleanup, condensate from steam heating of the acid storage tank, and any liquid that might accumulate within the dike. Provision is made to neutralize the sump with 18% NaOH. A sump pump is provided to transfer waste chemicals from the sump to the utility wastewater treatment unit.

The sulfuric acid receiving and storage system interfaces with the cooling tower system and the utility wastewater system.

Utility Wastewater System

The utility wastewater system receives cooling tower blow-down water. The waste stream is chemically neutralized, sampled, and passed to the steam system condensate polisher.

The utility wastewater system consists of a blow-down collection tank, utility wastewater pump, a package brine concentrator for salt removal, piping, instrumentation, and controls. The brine concentrator requires a supply of CaCl₂ and sulfuric acid. The product of the brine concentrator is the

feed to the condensate polisher. A small volume chemical waste stream from the brine concentrator is directed to an evaporation pond.

The utility wastewater system interfaces with the cooling tower and the central control and alarm system.

6.1.2.7 Instrumentation and Control

The pit disassembly and conversion facility processes both classified and unclassified SNM material. The philosophy for instrumentation and control has the remote processing operator handling the normal operation of the processes during two shifts, and the operations center handling the emergency situations in the absence of the remote processing operator.

The operations center monitors process status and alarms, criticality alarms, security alarms, fire alarms, and normal utilities including the HVAC system.

A block diagram for the digital distributed control system is shown in drawing E02.

Uninterrupted power is supplied for critical systems, including the operations center, security, personnel health systems, and the MC&A central computer.

6.1.2.8 Electrical

The electrical distribution system for the reference site for the PDCF is via a 480 V unit substation which consists of two 1500 kVA power transformers and 480 V switchgear. The switchgear is double ended with normally closed tie breaker. Each side of the switchgear will feed the motor control center and switchboard. The electrical one line diagram (drawing E01) shows the general electrical system configuration.

The equipment sizes were calculated taking into consideration the demand and diversity factor. The electrical connected load for PDCF is estimated to be close to 2900 kVA and the operating load is about 2200 kVA. This includes electrical load for HVAC and lighting for the facility.

Motor control centers (MCCs) will distribute 480 V power to all electrical loads rated 480 V. Chillers are the exception and will be powered directly from the double-ended switchgear. Power and lighting panel boards will be fed either directly from the 480 V switchboard via 208/120 V transformers. Numerous 480-208/120 V transformers and associated panelboards will be located for convenience receptacles and other small loads.

Essential loads such as the health physics systems (HPS) and DCS will be provided with uninterruptable power. During normal power failure, critical loads will be provided power via two 100 kW emergency generators. Loads such as for HVAC and chillers will be provided with standby power via a 1000 kW diesel generator.

6.1.3 Systems Engineering

Design Requirements analysis will be performed in accordance with DOE Order 430.1, 'Life-Cycle Asset Management' (LCAM.) This requires a breakdown of the project components into systems or elements that perform distinct functions. Each system is then analyzed to develop associated requirements. These requirements are developed in detail based on the PDCF functional and operational requirements (F&OR); and from applicable regulatory codes and standards. The associated documents are the project design requirements document (PDRD) and the standards and requirements identification document (SRIDS), respectively. The interfaces for each system should

be controlled in an interface control document and defined in drawings that denote the limit of the system and the interfaces at those limits. The systems engineering analysis will be performed in accordance with the Good Practice Guide, GPG-FM-010, associated with the LCAM.

6.2 Energy Conservation Approaches

The design of the facility will consider energy-conserving design. Such approach will apply the basic ASHRAE Standard 90 and other potential energy saving designs such as: (1) cascading of air from low potential to high potential for contamination with backflow protection, (2) recirculation of air on independent confinement zones with HEPA, and (3) heat recovery systems so long as the health and safety of personnel is not compromised. The energy conservation analysis will be initiated during Title 1 design.

6.3 Utility Assessment

During Title 1 design it will be necessary to conduct site-specific condition assessments of the utility systems. Site utility usage plans will need to be reviewed, and the condition and age of each system will need to be established. This includes determination of existing loads on and capacities of each system. The design basis at the reference site assumes that some utility services are available and have sufficient spare capacity to support the new PDCF. Existing reference site utilities include medium pressure steam and condensate systems, plant and potable water systems, and a sanitary wastewater treatment facility. Other utilities will be provided as part of the PDCF. Assumptions for the integration of utilities at the reference site are given in Section 6.5, Host Site Integration.

6.4 Environmental Considerations

One of the desirable attributes of the AIRES process is that no direct liquid wastes are produced. Particulate from the process is contained within the glove box or retained by filtration systems on the glove box exhaust system. Off-gases may be treated to remove potential hazardous gases. The management of waste is performed primarily within the facility until waste is packaged for disposition. Tritium is concentrated by getters and/or catalytic conversion. Retained tritium is concentrated/collected and packaged (all within the facility) for safe disposal. The minimization of waste production, combined with the overall facility design to contain potential contamination will minimize adverse environmental impact. Provision is made to collect potentially contaminated fluids, such as fire water or site run-off, in order to test for acceptable conditions before release.

Highly reliable effluent monitoring provides confidence that the expected low level of environmental impact is realized.

Estimates of emissions and waste generation have been made for the PDCF and applicable regulations were reviewed. Major environmental considerations are air quality, water quality, waste generation, and pollution prevention.

6.4.1 Air Quality

The National Emission Standards for Hazardous Air Pollutants (NESHAPs) are applicable to the PDCF, specifically regulating emissions of beryllium and radionuclides to the ambient air. NESHAPs limits beryllium emissions from stationary sources to 10 g (0.02 lb) over a 24-h period. Emissions of radionuclides from DOE facilities are limited so as not to cause any member of the public to receive a dose equivalent of 10 mrem/yr. The radionuclide limitation includes all sources at

the site and is determined at the site boundary. The beryllium limit may be applied to individual facilities or to the entire site based on state interpretations of the regulations.

An application for approval of construction or modification of an existing source is mandatory for the owner or operator of beryllium or radionuclide operations. However, a preconstruction approval application can be exempted if the EDE is less than 0.1 mrem/yr, and for beryllium, if the ambient concentration limit in the vicinity of the stationary source is $0.01 \mu\text{g}/\text{m}^3$, average over a 30-day period. The application process for preapproval of construction under NESHAPs generally takes about 3–6 months.

Beryllium is handled in the PDCF as relatively large pieces. The pit cutting operations will make beryllium chips and turnings, but these are relatively large particles not easily entrained. All beryllium operations are conducted in glove boxes. The ventilation exhaust from the glove boxes is filtered through three stages of HEPA filters before release to the ambient air. Beryllium emissions should easily meet the regulations.

Radionuclide emissions from the PDCF have been estimated and the current compliance with the 10 mrem/yr dose limit reviewed for each of the candidate sites. The radionuclide emissions from the PDCF should not cause noncompliance with the limit at any of the candidate sites. Monitoring of radionuclides emissions from the PDCF is required.

Other state and local air permits may be required to address carbon monoxide, nitrogen oxide, and sulfur dioxide emissions from the diesel-powered emergency generator and from building heating equipment if fossil fuels are used for that purpose. These permitting activities require that attention is paid to the emission potential of this equipment when it is specified. Meeting the air quality requirements should not require unusual pollution control equipment and obtaining the required air permits should be possible within the project schedule.

6.4.2 Water Quality

Very small quantities of liquid waste contaminated with radioactivity are expected from the process and the analytical laboratory. The process liquid waste is small quantities of electrochemical solutions that can be evaporated in a glove box and handled as solid waste. Similarly, radioactive liquids from the analytical laboratory can be solidified.

Sanitary wastewater from sinks, toilets, showers, and blow-down from the cooling tower are the major wastewater sources from the PDCF. These will be handled by existing wastewater treatment facilities at the selected site.

Depending on the site selected for the PDCF, a National Pollution Discharge Elimination System (NPDES) permit modification may be needed for the wastewater. If the existing sanitary wastewater treatment plant discharges under an existing NPDES permit, the permit may need to be modified adding the PDCF as a source of wastewater to the treatment plant. An application to modify the permit must be submitted at least 180 days before the discharge is intended to commence.

Best management practices (BMPs) as specified by 40 CFR 122.2 must be employed to control storm runoff. Site development must address storm-water runoff control and a storm-water runoff permit must be obtained for the PDCF, or the site permit modified if there is a site-wide storm-water runoff permit.

6.4.3 Waste Generation

TRU waste will be generated and handled in accordance with DOE Order 5820.2A, "Radioactive Waste Management" and packaged to comply with "Waste Acceptance Criteria for the Waste Isolation Pilot Plant," Revision 5.0 (WIPP-DOE-069). Major TRU waste includes non-SNM declassified pit parts, worn parts and tools, and used glove box gloves. TRU waste will be assayed at the PDCF. Storage of TRU waste is limited to that needed to accumulate sufficient volume to efficiently ship to other on-site waste management facilities.

LLWs will be generated at the PDCF and includes general maintenance items from the process area. The residue from solidifying the electrocleaning solutions and sludges are anticipated to be LLW, but may contain sufficient actinides to be TRU waste. A small amount of tritium will be captured on getter beds and disposed of as LLW. LLW will be handled in compliance with the requirements of DOE 5820.2A and packaged to comply with LLW disposal requirements specific to the site at which the facility is located. LLW will be assayed and packaged at the PDCF. Storage of LLW is limited to that needed to allow efficient shipment to other on-site waste management facilities

Very small quantities of hazardous waste, mixed-TRU waste, and mixed LLW are anticipated from the process and analytical laboratory in the PDCF. Handling of hazardous waste in the facility will be limited to accumulation and storage. Accumulation and storage must meet Resource and Conservation Recovery Act (RCRA) regulations. A small accumulation area is anticipated, requiring only notification of the regulatory agency. A RCRA permit is not needed.

6.4.4 Pollution Prevention

Pollution prevention is required to be addressed by a number of federal regulations, executive orders, and DOE orders including RCRA, the Pollution Prevention Act (42 USC et seq. 13101-13109), and DOE 5400.1, "General Environmental Protection Program." DOE 5400.1 requires that each site develop a pollution prevention plan. Pollution prevention has already been considered in the design of the baseline technology resulting in the predicted low emission rates and waste generation rates and will continue to be considered in the subsequent PDCF development. Pollution prevention was formally considered in the PEIS and is being considered in the SPD EIS. A pollution prevention plan covering the PDCF will have to be prepared either as a separate plan or as a modification to a site-wide plan.

6.5 Facility and Equipment Maintenance Considerations

The support area has two small maintenance shops. One shop provides maintenance for contaminated equipment from the analytical laboratory. The other shop is a cold maintenance shop dedicated to the repair or replacement of uncontaminated equipment.

The basic maintenance philosophy for the analytical laboratory is to perform in-situ equipment maintenance where possible. When in-situ maintenance is not practical, the item is brought to the decontamination area and surveyed to determine whether decontamination is required. If decontamination and repair is not deemed appropriate, the item is sent to the waste management area and replaced.

In addition to general maintenance, the cold maintenance shop has the capability to provide some light fabrication and facility repairs (e.g., electrical, piping, plumbing, etc.) for the whole facility.

Maintenance within the facility MAA is facilitated by the compartmentalized arrangement of the process operation areas. Operations can continue in compartments adjacent to maintenance activities.

6.6 Safety Considerations

ES&H monitoring for the PDCF will be provided to monitor releases to the environment, personnel at the facility, and conditions at the facility site and surrounding environment in compliance with DOE Order 5400.1. ES&H monitoring will use manual monitoring operations and data gathering as well as a special-purpose computer system to acquire and report data and alarms and to display status. ES&H monitoring will provide the following minimum functions and equipment to support requirements for sampling, monitoring, data acquisition, and recordkeeping:

- Instrumentation for monitoring and alarm of radiation, radiological contamination, and nonradiation/hazardous material conditions
- Alarm for environmental releases and trends for potential exposures and releases
- Acquisition and reporting of data from automatic and manual monitoring instrumentation including the following: personnel survey, liquid effluent, stack effluent (isokinetic), hazardous gas, criticality, area radiation monitors, and CAMs
- Maintenance of data for personnel health records, surveys, inspections and evaluations of hazardous areas, instrument calibration, threshold limits, and administrative records
- Air sampling and monitoring for radioactive (if applicable) and hazardous materials

6.7 Safeguards and Security Considerations

6.7.1 Physical Security

The design will comply with the requirements of DOE O 420.1, "General Design Criteria," 5632.1C, "Protection and Control of Safeguards and Security Interests," and Draft DOE Order M 473.1-1, "Manual for Physical Protection of Safeguards and Security Interests." The PDCF will be designed to mitigate the threats identified in the DOE "Design Basis Threat Policy for the Department of Energy Programs and Facilities."

6.7.2 Material Control and Accountability System

The safeguards system for the PDCF establishes an integrated system of nuclear materials accounting and nuclear materials control as required by DOE Order 5633.3B and other DOE orders. This system monitors transfer of nuclear materials in the facility to continuously account for all SNM and to ensure that unauthorized removals of SNM do not occur. Performance requirements of the MC&A system is integrated with the physical security system to provide assurance that theft or diversion of nuclear material has not occurred. The safeguards system is designed to mitigate or prevent radiological and toxicological sabotage events.

The material control portion of the safeguards system governs internal transfer (or movement), location, access, and use of nuclear material; and monitors the status of material movement and inventory. The material control system has access to data from the plant process control, criticality safety, ES&H, and the access control systems to detect abnormal situations involving SNM and/or MC&A system components.

The accountability system provides a means of physically accounting for the location and quantity of nuclear material and is supported by proven measurement control methods and procedures. New technologies and automated techniques are implemented, where practical, to reduce requirements for employee access to SNM and to reduce employee exposure to hazardous environments.

Three material balance areas (MBAs) are located within the MAA: one MBA is in the receiving area, the second where conversion to oxide takes place, and the third area is where IAEA operations take place. Outside the MAA, additional MBAs in the analytical laboratory and the waste management

area track Category III and IV materials before final disposition. There is also an existing waste storage building with its own MBA for Category III and IV materials.

Movement of Category I SNM material/items is tracked by use of bar code readers and/or data terminals located adjacent to each operating station or material transfer point. This tracking approach enables the MC&A computer system to maintain near-realtime inventory and location information for all SNM in the facility. Results of measurements are transferred directly to the computer by data link from the MC&A instruments or by input to the data terminals which are strategically located throughout the facility. The MC&A system utilizes NDA instruments located in the material receiving area the shipment and process area, depending on the type of material being measured.

In the material confirmation area, the contents of each shipping package are confirmed by performing a weight and gamma/neutron fingerprint measurement. These measurements should match similar measurements made at the donor site before shipment. DOE Order 5633.3B requires that the confirmation measurements be made within five working days of receipt at the facility for Category IB material (pits and metal).

Certain measurements may be made by independent inspectors in the international inspection area. These measurements (and instruments to be used) will be specified in agreements with the IAEA and will not reveal classified data. CCTV cameras and special recorders may also be used to monitor material movements. The inspectors may also be supplied with unclassified data from the facility computer systems.

MC&A equipment includes the MC&A computer system with operator consoles and peripheral equipment located in the MC&A operating area, scales and NDA radiation measuring instruments, data terminals and bar code readers, and calibration standards.

Input and measurement functions include shipping/receiving data input, NDA measurements, weight measurements, and SNM location data from data input terminals bar code readers, and the material handling system.

Database functions include the working database (near-realtime inventory), the official DOE database for reporting to the National Nuclear Materials Management and Safeguards System (NNMSS), internal and external report generation, inter-facility transfer records, and data archives. The working database includes records by MBA of SNM items bulk materials, process holdup, analytical samples and calibration standards, empty shipping containers, and waste in the MAA. Waste outside the MAA containing reportable quantities of SNM is also included if it has not been transferred to a repository or other entity.

The instrument control subsystem controls and collects data from the NDA and weight instrumentation. It also performs calculations, generates reports, validates data, calibrates instruments, and maintains instrument operator qualification and training records.

The MC&A system interfaces with other computer systems, including the DCS, material handling, work scheduling, physical security, ES&H, CCTV, IAEA remote terminal, and the information security system.

The anomaly detection and assessments system monitors and correlates the activities recorded by the MC&A system and related computer systems to detect any unusual location, occurrence, or pattern concerning SNM. Unusual circumstances are assessed to determine if diversion or theft may be occurring.

Miscellaneous functions include periodic performance testing, operator training and qualification, computer system maintenance and development, periodic inventories, and information security.

6.8 Host Site Integration

The PDCF will be built at an existing DOE site and must integrate with the infrastructure and support systems at the selected site. The following tables include the site integration assumptions used to prepare the conceptual layout of the facility and to determine the life-cycle cost in this document. The assumptions were reviewed against conditions at each site, and while differences exist between sites, the assumptions provide adequate coverage of conditions at all the candidate sites.

Table 6.1
Integration With Site Utility Systems

System	Assumption
Normal electrical power	Electrical service is available at the site and can be extended to the PDCF
Secondary electrical power	Secondary power is available at the site and can be extended to the PDCF
Emergency power	The PDCF will have its own emergency generator
UPS	The PDCF has its own UPS
Ventilation system	The PDCF has its own ventilation system
Building and water heating systems	Building and water heat are provided by PDCF equipment that burns natural gas
Cooling water	The PDCF has its own cooling tower
Chilled water	The PDCF has its own chilled water system
Fire water	The site fire water system is adequate and is extended to serve the PDCF
Domestic water	The site domestic water system is adequate and is extended to serve the PDCF
Fire water collection	Fire water collection is provided as part of the PDCF
Water treatment	The domestic water is treated as required for use in the cooling tower, building heating system, and laboratory
Vacuum systems	The PDCF has its own process vacuum system
Argon system	The PDCF has its own argon storage and distribution system, the system includes recycle of argon
Helium system	The PDCF has its own helium storage and distribution system
Nitrogen system	The PDCF has its own nitrogen storage and distribution system
Hydrogen system	The PDCF has its own hydrogen storage and distribution system
Oxygen system	The PDCF has its own oxygen storage and distribution system
Plant/instrument/breathing air systems	The PDCF has its own air systems
Spare equipment	An inventory of critical spare equipment is maintained at the PDCF
Failed equipment	Contaminated failed equipment is repaired in a separate shop located in the PDCF or handled as waste in the PDCF

**Table 6.2
Integration of Infrastructure Support**

Support item	Assumption
Fitness for duty programs	The PDCF relies on site programs
Environmental monitoring	Site programs provide the overall monitoring program; release points from the PDCF are monitored
Transportation	Transportation support is provided by the site; loading and unloading activities are included in the PDCF
Cafeteria	The PDCF provides a lunchroom, but no hot food services
Emergency response	Emergency response is provided by the site, first response equipment is included in the PDCF
Training	Employee training is provided by the site
Health protection	Dosimetry programs are provided by the site, workplace monitoring is provided as part of the PDCF
Security	Guard forces are provided by the site; access control is provided as part of the PDCF
Fire station	Fire response crews and equipment are provided by the site; fire alarm systems, fire protection systems, and fire extinguishers are provided as part of the PDCF
Receiving/warehouse	Receiving and warehouse services are provided by the site; limited warehousing for consumables is provided at the PDCF
Medical	Medical services are provided by the site; first aid equipment is available in the PDCF
Analytical laboratories	Analytical laboratories are provided as part of the PDCF
MC&A systems	The PDCF has its own MC&A system that can communicate with the site system
Communications	The PDCF has internal communication systems (phones, pager, and alarms) that integrate with the site
Computer support	The PDCF maintains a core competency to maintain computer systems, but relies on the site for major acquisitions and upgrades
Calibration/standards	The PDCF maintains a core competency to calibrate equipment, but relies on the site for maintaining the calibration and standards program
Engineering services	The PDCF maintains a core competency to follow the process and maintain the facility, but relies on the site for major design efforts
Laundry	Laundry is handled by the site external to the PDCF
Maintenance shop	The PDCF has a maintenance shop for contaminated items; craftsmen and major shop efforts are provided by the site

**Table 6.3
Integration of Waste Handling**

Support item	Assumption
Sanitary waste	Sanitary waste is handled by the site in existing facilities
LLW	LLW is assayed, packaged, certified, and accumulated in the PDCF, then moved to site waste management facilities for long-term storage and/or disposal
TRU waste	TRU waste is assayed, packaged, certified, and accumulated in the PDCF, then moved to site waste management facilities for long-term storage and loading for transport to WIPP; final certification procedures for TRU, including gas testing and gas venting, are done at site waste management facilities
Mixed LLW	Mixed LLW is assayed, packaged, and accumulated in the PDCF, then moved to site waste management facilities for long-term storage and/or disposal
Hazardous waste	Hazardous waste is accumulated in the PDCF, then moved to site waste management facilities for packaging, and long-term storage and/or disposal

6.9 Conceptual Drawings

Conceptual design drawings are in Appendix B. An index of the drawings is shown on drawing T01.

6.10 Preliminary Equipment List

The equipment list is in Appendix C.

7.0 PROJECT MANAGEMENT AND IMPLEMENTATION

Project management during the design phase of the project involves establishing a baseline and managing performance of design activities to the baseline. This baseline will have three elements

- Technical basis – ensures that the design meets the technical requirements established in the conceptual phase.
- Cost basis – establishes cost goals and variance thresholds for each element of the design contract
- Schedule basis – establishes schedule and milestones for the performance of design activities

QA requirements will also be established per the OFMD's QA Plan.

7.1 Project Management Team and Responsibilities

The project management team for the design phase will consist of:

OFMD Project Manager
Contracting Officer (CO)
Contracting Officer's Representative (COR)
Operations Office Project Manager
Architect-Engineer Project Manager
Laboratory Technical Design Consultant

7.1.1 OFMD Project Manager

The overall responsibility for the project lies with the Director, OFMD. The OFMD Project Manager designated by the Office Director has overall responsibility for overseeing the preparation of facility design, acting as the main link between the Operations Office and Headquarters, and reporting to the Office Director on project performance. The OFMD Project Manager is responsible for defining programmatic requirements of the OFMD, ensuring that these requirements are included in the project scope and that the programmatic requirements are satisfied.

7.1.2 Contracting Officer

The CO is responsible for the execution of procurement, contracting, and contract administration.

7.1.3 Contracting Officer's Representative

The COR is responsible for providing the necessary liaison between the Architect-Engineer project manager and the CO on technical, cost, and schedule matters. The COR reviews invoices submitted by the contractor, recommends payments based on performance, conducts inspections and acceptance of performance and deliverables, and recommends corrective actions on any noted deficiencies to the CO.

7.1.4 Operations Office Project Manager

The Operations Office Project Manager will have the day to day oversight responsibility for project activities.

7.1.5 Architect-Engineer Project Manager

The Architect-Engineer Project Manager will be responsible for managing design activities and for the delivery of the preliminary and final design, drawings, and specifications, within scope, cost, and on time.

7.1.6 Laboratory Technical Design Consultant

The Los Alamos National Laboratory and the Lawrence Livermore National Laboratory are responsible for providing expert advice and guidance on the contractor's compliance with the PDCF technical, functional, and ES&H requirements through the OFMD Project Manager.

7.2 Project Management System

A project management system will be developed that is in compliance with DOE Order 430.1 based on the risk assessed in the performance of design activities. Elements of the system include technical, cost, and schedule controls graded to the assessed risk of the each of these elements during the design phase. A work breakdown structure (WBS) will be used for the definition of work elements containing individual work scope, cost, and schedule units for planning and performance measurement.

7.2.1 Work Scope and Technical Baseline Management

A systems engineering process will be used to develop and approve tasks/work packages to meet technical objectives. Change control for work scope will be managed by the project team and reviewed by a change control board.

7.2.2 Cost Control

Cost controls will involve the development of individual WBS elements or task budgets and the preparation of cost management reports detailing planned costs for each element. Actual costs reported by the A/E in each element will be reviewed based on an earned value system or an appropriate and equivalent assessment of work performed in terms of deliverables and completion milestones.

7.2.3 Schedule Control

Schedules for the accomplishment of design milestones and deliverable products will be established in each design WBS element. Activity progress will be assessed for each milestone/product based on completion or a percentage completion of the activity progress.

7.3 Project Execution

During the conceptual phase, the program office, using a graded approach, will ensure development of the initial project execution plan (PEP). The initial planning shall include the information identified in the Joint Program Office Direction on Project Management, a companion document to DOE Order 430.1. Over the course of the project, the PEP will be updated.

7.4 Procurement Strategy

In evaluating the procurement strategy, OFMD examined the issue of whether the investment required for this project needs to be undertaken by the government or is there an alternative private sector source that can better undertake this investment. This issue is addressed in the following section.

7.4.1 Privatization

Privatization is not considered practical because of the following:

- The inherently higher risk of inadequate project performance due to the absence of commercial experience in the disassembly of pits and the conversion of plutonium.
- The risk of nonperformance by a private contractor could effect international nonproliferation and disarmament efforts.

7.4.2 Method of Performance

Although the DOE's preferred option is for a fixed price contract for engineering design, the DOE reserves the option of awarding a cost-plus contract. It is anticipated that the construction procurement will be a fixed price contract awarded on the basis of competitive bidding.

7.5 Risk Assessments

A technical risk analysis (TRA) and a preliminary hazards analysis (PHA) have been prepared for the PDCF. The TRA identified technical problems and program issues so that both could be resolved in a manner that complements the development schedule for the PDCF. The PHA was leveraged from hazards analysis for the ARIES pilot demonstration and identifies design features needed to mitigate major hazards. No technical problems, program issues, or hazards were found that preclude the safe design and ultimate mission success of the PDCF.

7.6 Quality Assurance

7.6.1 Project Quality Management Plan

A project quality management plan (PQMP) will be prepared. The PQMP is the top-level QA document which describes how the A/E will meet the applicable QA requirements and identifies applicable implementing project procedures.

7.7 Work Breakdown Structure

Figure 7-1 is the proposed WBS for the DOC DR for the PDCF. It has been structured to be integrated with the other material disposition projects, MOX Fuel Fabrication Facility and the Immobilization Facility. Accordingly, the PDCF, MOX, and Immobilization Facility are shown as Level 1 tasks.

Level 2 tasks include the following:

- Project management – Site management and operations (M&O) contractor who has the overall responsibility for defining and managing subcontracts for engineering design, procurement, construction, and D&D. It is assumed operations will be by the M&O.

- Engineering design – A/E subcontractor for Title I, II, and facility design.
- Procurement – Procurement of special equipment such as HYDOX reactors, glove boxes, etc.
- Construction – Construction subcontractor.
- Other project costs – Activities before Title I activities, testing, and startup.
- Operations – M&O operations staff.
- D&D.

Level 3 includes the following:

- Preliminary design – Includes A/E management, plant design, process design, mechanical design, electrical design, development of specifications, and systems engineering.
- Detail design – Includes A/E management and design deliverables for site, process, and support buildings SSCs, and systems engineering.

Engineering support during construction (Title III).

Pit Disassembly & Conversion Project (PDCF) Proposed Work Breakdown Structure

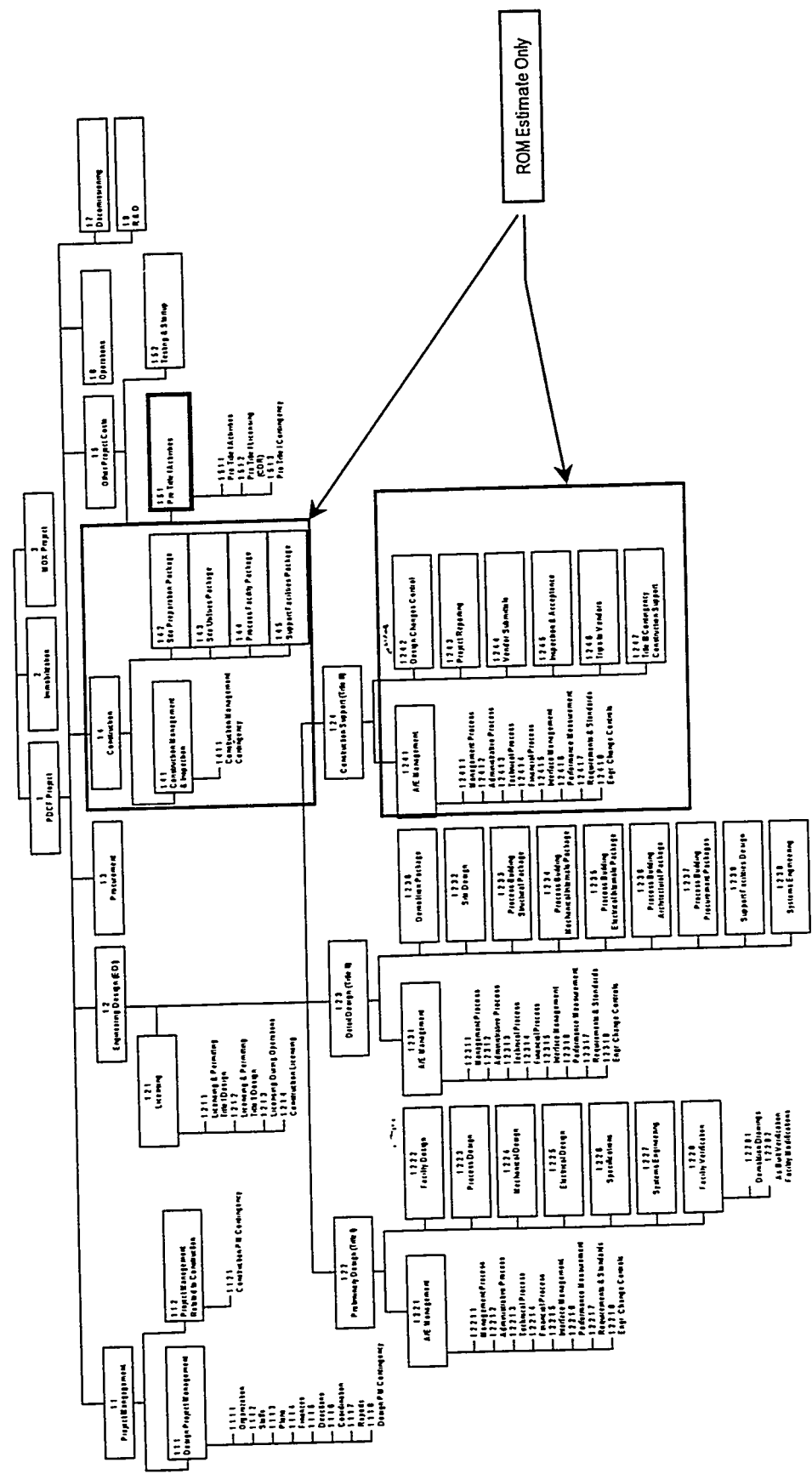

Fig. 7-1. Pit Disassembly & Conversion Project Proposed WBS

8.0 SCHEDULE BASIS

8.1 Engineering Schedule

The project engineering schedule was developed from the labor estimate and comparison of historical data from other project schedules that contain similar engineering activities. The duration for the activities were derived two ways:

- 1) Calculate the total estimated man-hours for the task with the primary focus on the lead resources total man-hours divided by eight.
- 2) Compare historical data. The logical relationship for the tasks was developed by comparisons with other project schedules that contain similar engineering tasks. A network of logical relationships has been established using Primavera[®] project management software.

8.2 Construction Schedule

Construction activities are preliminary. Construction activities identified in the following schedule were developed by an Architect-Engineer, Burns and Roe, and are currently under review by DOE.

The complete summary schedule is located in Appendix D.

9.0 COST AND FUNDING PLAN

A. Engineering Cost and Contingency (in forth quarter FY97 dollars)

Description	Estimated Cost K\$	Contingency K\$	Total Cost K\$
Preliminary Design, Title I	12 495	2985	15 480
Final Design, Title II	20 888	4710	25 597
Project Management (PM) During Design	3908	1758	5666
TEC Design Phase Cost	37 291	9453	46 743
Other Project Costs (OPCs)	10 000	2000	12 000
Total Project Cost (TPC) Design Phase	47 291	11 453	58 743

B. Project Cost and Contingency (in forth quarter FY97 dollars)

Description	Estimated Cost K\$	Contingency K\$	Total Cost K\$
Total Estimated Cost (TEC)	239 559	100 474	340 033
OPCs			246 346
TPC			586 379
Operations Maintenance			527 815
Total Lifecycle Cost			1 114 194

Cost summary reports are in Appendix E

9.1 Estimate Basis

Introduction and Summary

This planning or feasibility estimate presents the lifecycle cost (LCC) of the PDCF in fourth quarter 1997 dollars. This estimate is based upon a reference site located on DOE property and is intended to be a bounding estimate for the cost of the facility.

The cost scope presents the LCC developed for a 10-year operating period. The LCC includes the TPC, M&O costs, and D&D costs. The technical scope used for this estimate includes preliminary drawings, sketches, and equipment lists. Preliminary drawings are in Appendix B and equipment lists are in Appendix C.

9.1.1 General Assumptions

The general assumptions used in the estimate are listed below:

- All costs, LCC and engineering design and inspection (ED&I), are presented in fourth quarter 1997 dollars. Escalation is not included.
- The site is located on DOE land, hence, no land acquisition or permitting fees will be incurred.
- Labor costs are based on a 40-hour workweek with an adequate supply of skilled and unskilled labor in the area.
- It is assumed that the construction site is clean of any contamination before mobilization for construction.
- Engineering and design will be executed by an A/E under a subcontract to the DOE Site M&O Contractor.

9.1.2 Work Breakdown Structure

A WBS developed for the PDCF engineering estimate was used for the LCC estimate.

9.1.3 Total Project Costs

The TPC, in fourth quarter 1997 dollars, include OPCs and TECs. OPC is composed of pre-Title I activities and start-up. TEC is the sum of field direct and indirect costs, construction management, engineering, and project management.

9.1.4 Construction Wage Rates

The burdened construction wage rates include base rate, fringes, travel, State Unemployment Insurance, Federal Unemployment Insurance, Social Security, and Workman's Compensation. The craft wage rates, as supplied by Burns & Roe, are listed in Table 9.1.

Table 9.1. Craft Burdened Wage Rates

Craft	Adjusted Wage (\$/hour)
Boiler Maker	\$29.89
Bricklayer	\$20.52
Carpenter	\$26.10
Electrician	\$26.53
Operator	\$30.34
Laborer	\$13.25
Millwright	\$29.34
Painter	\$17.36
Pipefitter	\$27.43
Roofer	\$18.25
Steam/Pipefitters	\$27.43
Sheetmetal Worker	\$28.39
Sprinkler Fitter	\$27.43
Teamster	\$14.74

The crew rates are developed from craft rates. These rates are shown in Table 9.2.

Table 9.2. Crew Rates

Basic Crew	\$/Man-hour
Excavation & Sitework	\$16.46
HVAC	\$27.95
Interior	\$24.56
Sprinkler	\$26.97
Equipment	\$28.29
Piping	\$26.97
Electrical	\$26.21
Instrument	\$26.52

9.1.5 Indirects and Taxes

The indirect field costs (IFCs) are derived from the direct field costs (DFCs) which include labor, equipment, material and subcontracts (SCs). The IFCs include a \$3.00/man-hour for construction equipment rental (ER), 19% of DFC + ER - SC for contractor overhead (OH), 5% of subcontract for subcontractor management (SF), 5% of DFC + ER + SF + OH - SC for profit (PF), and 1% of DFC + ER + OH + SF + PF for bond.

In lieu of taxes, a 53% surcharge is applied at the total cost of each contract for the first \$500,000.

Construction management is computed to be 10% at the total direct and indirect costs.

9.1.6 Engineering and Management

Engineering and design for Title I and Title II costs are based on a detailed estimate.

The detailed estimate for Title I design was developed at level 5 of the WBS and summarized on a task-deliverable basis for A/E management, facility design, process design, mechanical design, electrical design, outline specifications, and systems engineering at level 4.

The detailed estimate for Title II design was developed at level 5 for A/E management and systems engineering tasks and summarized to WBS level 4 for construction package deliverables for site design, process building structural design, process building mechanical internals design, process building electrical internals design, process building architectural, and support facilities.

Design/engineering labor rates were developed as averages for a generic, major, United States-based A/E company.

Other direct costs (ODCs) are included for each work activity and were calculated based labor hours using average historical data for the design for DOE construction project of a similar magnitude. ODCs included are reprographics/word processing, mainframe computer, supplies and miscellaneous, and communications.

Title III design is a factor at 5% of total field costs.

Project management costs are computed at 7.5% of the total field cost for Title III and construction.

Project management during Title I and Title II were estimated directly.

9.2 Estimate Assumptions and Methodology

The following sections summarize the methodology and assumptions used in the TPC estimate.

9.2.1 Sitework

The sitework costs are based on Flour Daniel, Inc. historical data for cost per acre. The costs include clearing, utility distribution, paving, lighting, etc. Allowances were made for minimal demolition and a temporary PIDAS.

9.2.3 Site Support Facilities

The site support facilities costs are based on Flour Daniel, Inc. historical data of similar facilities. The size and types of facilities were based on the EIS data call response, "Pit Disassembly and Conversion Facility Environmental Impact Statement Data Report - Pantex Plant", (LA-UR-97-2909 -final draft).

9.2.4 Procurement Equipment

The procurement equipment and computer systems costs were based on preliminary priced equipment lists developed by Flour Daniel, Inc.

9.2.5 Main Process Building

The main process building costs are mainly based on historical data of similar plutonium buildings. Square foot costs were developed for the building shell, fire protection, electrical, security, and health physics. Piping and instruments were factored from the equipment costs. HVAC costs were developed from a preliminary priced equipment list developed by Flour Daniel, Inc.

9.2.6 Other Project Costs

The OPCs are divided into two major areas, design phase activities and lifecycle activities. Design phase activities include all engineering efforts prior to validation and approval of title design. These activities include conceptual design, safety analysis report, environmental documentation, and research and development costs. Environmental documentation and research and development costs were provided by OFMD and are based upon current budget projections.

Startup costs are all the activities required after mechanical completion to prepare for the operational readiness review. These activities include nonradioactive and radioactive start-ups, product certification, and hiring and training employees. Start-up staffing was computed using a maximum staffing level of 400 persons.

9.2.7 Management and Operation Costs

The M&O costs are defined for this estimate as the complete operational cost of the plant over its expected life of 10 years. The costs include labor, consumables, maintenance repair, utilities, and waste disposal. Operation management fees and transportation of plutonium to and from the facility are not included.

9.2.7.1 M&O Labor Costs

The labor for operations was developed by staffing the facility for a representative year. The staffing is based on fulltime equivalents (FTEs) as shown in the "Estimates of Staffing for the Pit Disassembly and Conversion Facility, (LA-UR 97-1844). Labor rates for the referenced site were supplied by DOE as annual salaries for each service level.

9.2.7.2 M&O Non-labor Costs

Non-labor costs, include consumables, maintenance/repair, utilities, and waste disposal. Consumable material is computed as 8% of operating labor. Maintenance/capital replacement costs were developed as 2.5% of TEC without contingency per year.

9.2.7.3 Utility Costs

Utility costs are the electrical, natural gas, and diesel fuel consumption is based on data from the EIS data call response. The utility rates used are:

electricity \$.0354/kwh

natural gas \$2.40/mcf

diesel fuel \$1.50/gal.

9.2.7.4 Waste Disposal Costs

Waste disposal includes sanitary, hazardous, and radioactive low-level waste. There is no high-level waste from this facility. Sanitary and hazardous waste disposal is assumed on-site or locally with the costs included in consumables. The TRU low-level waste is to be sent to WIPP in New Mexico at a disposal fee of \$5000 per barrel. Other low-level waste will be sent to Envirocare in Utah at a cost of \$70/ft³.

9.3 Contingency

A probabilistic risk analysis (PRA) was performed on the engineering estimate for Title I and Title II to determine the appropriate contingency. This analysis involved development of high, low, and median values for each of the Level 5 WBS elements. These values were used to establish the probability distributions for each level 4 WBS element which were then combined into a single probability distribution by utilizing a random sampling program. In this particular case the model utilized was Latin Hypercube with 2000 iterations. The result of this analysis was a range of contingency values for various levels of confidence. The level selected was a 90% confidence level which means that there is a 90% probability that the resultant will not be exceeded. This analysis was performed for the engineering effort at the reference site. There are currently four sites under consideration. However, the preliminary analysis indicates that the reference site is the bounding case.

A deterministic risk assessment was performed on the construction and operating activities to determine appropriate contingencies. The contingency percentages were discussed with a team of experienced estimators from three separate A/E firms and a consensus reached on the appropriate contingency levels. This analysis assumed that the technology under development in the R&D program develops successfully. There is the possibility that this assumption is incorrect and significant changes need to be made to the assumed process systems. This possibility was addressed by the addition of a contingency for technical uncertainty. The resultant contingencies are as shown in the estimate summaries and detailed backup.

References

- Department of Energy, "Storage and Disposition of Weapons-Usable Fissile Materials Programmatic Environmental Impact Statement," DOE/EIS-0229, (December 1996)
- Federal Register, "Record of decision for the Storage and Disposition of Weapons-Usable Fissile Materials Final Programmatic Environmental Impact Statement," 62 FR 3014 (January 14, 1997)
- President Bill Clinton, "US Nonproliferation and Export Control Policy," Presidential Decision Directive-13 (September 23, 1993)
- David Curtis, "Advanced Recovery and Integrated Extraction System Source Term Fact Sheet," Los Alamos National Laboratory document LA-CP-97-93 (1997)
- Lowell Christensen, et al., "Process Logic Flow Diagram for Pit Disassembly and Conversion for Fissile Material Disposition," Los Alamos National Laboratory document LA-UR-97-753 (1997)
- Barbara Sinkule, "Waste Isolation Pilot Plant Waste Acceptance Criteria Fact Sheet," Los Alamos National Laboratory document LALP-97-54 (1997)
- Department of Energy Standard, "Criteria for Preparing and Packaging Plutonium Metals and Oxides for Long-Term Storage," DOE-STD-3013-96
- Department of Energy, "Waste Acceptance Criteria for the Waste Isolation Pilot Plant," Rev. 5, DOE/WIPP-069
- Stanley Zygmunt, "Estimates of Staffing for the Pit Disassembly and Conversion Facility," Los Alamos National Laboratory document LA-UR-97-1844, (1997)
- Barbara Sinkule, et al., "Pit Disassembly and Conversion Facility Environmental Impact Statement Data Report - Pantex Plant," Los Alamos National Laboratory document LA-UR-97-2909 (1997 - final draft)

ACRONYMS AND ABBREVIATIONS

Acronyms

AASHTO	Association of State Highway and Transportation Officials
ACI	American Concrete Institute
A/E	architectural/engineering
AGV	automated guided vehicle
AISC	American Institute of Steel Construction
ALARA	as low as reasonably achievable
ANS	American Nuclear Society
ANSI	American National Standards Institute
APSF	Actinide Packaging and Storage Facility (Savannah River Site, SC)
ARI	American Refrigeration Institute
ARIES	Advanced Recovery and Integrated Extraction System
ASCE	American Society of Civil Engineers
ASHRAE	American Society of Heating, Refrigeration and Air-Conditioning Engineers
ASME	American Society of Mechanical Engineers
ASTM	American Society of Testing and Materials
BET	Brunauer-Emmett-Teller
BMP	best management practice
CAM	continuous air monitor
CCTV	closed circuit television
CD	critical decision
CEQ	Council on Environmental Quality
CFE	critical flood elevation
CFR	Code of Federal Regulations
CO	contracting officer
COR	contracting officer's representative
CRT	cargo restraining transport
DBA	design-basis accident
DBE	design-basis earthquake
DBFL	design-basis flood
DCS	distributed control system
D&D	decontamination and decommissioning

DFC	direct field costs
DIW	deionized water
DNFSB	Defense Nuclear Facilities Safety Board
DOCDR	Design-only Conceptual Design Report
DOE	Department of Energy
EDE	effective dose equivalent
ED&I	engineering design and inspection
EIS	environmental impact statement
EPA	Environmental Protection Agency
ER	equipment rental
ES&H	environmental safety and health
FAS	fixed head air sampling
FDPA	Fluorinel Dissolution Process Area (INEEL, ID)
FHA	fire hazards analysis
FL	fail last
FMEF	Fuels and Materials Examination Facility (Hanford, WA)
F&OR	functional and operational requirements
FPF	Fuel Processing Facility (INEEL, ID)
FTE	full-time equivalent
GB	glove box
GDHS	Geometric Design of Highways and Streets
GPG	Good Practices Guide
GRIS	gamma-ray infrared scanner
HEPA	high-efficiency particulate air
HEU	highly enriched uranium
HPS	health physics systems
HVAC	heating, ventilation, and air conditioning
HYDOX	hydride/oxidation
IAEA	International Atomic Energy Agency
I&C	instrumentation and controls
ICP	inductively coupled plasma
ICPP	Idaho Chemical Processing Plant (INEEL, ID)
ICRP	International Commission on Radiation Protection
IES	Institute for Environmental Studies
IFC	indirect field costs
INEEL	Idaho National Engineering and Environmental Laboratory

INPO	Institute for Nuclear Power Operations
IR	infrared
LCAM	lifecycle asset management
LCC	lifecycle cost
LLMW	low-level mixed waste
LLW	low-level waste
LN	liquid nitrogen
LOI	loss on ignition
LV	limited volume
MAA	material access area
MBA	material balance area
MC&A	material(s) control and accountability
M&O	management and operations
MOX	mixed oxide
MTRU	mixed transuranic
NDA	nondestructive assay
NEC	National Electric Code
NEPA	National Environmental Policy Act
NESHAPs	National Emission Standards for Hazardous Air Pollutants
NFPA	National Fire Protection Association
NIR	near infrared
NNMSS	National Nuclear Materials Management and Safeguards System
NPDES	National Pollution Discharge Elimination System
NPH	natural phenomena hazard
NRC	Nuclear Regulatory Commission
ODC	other direct cost
OFMD	Office of Fissile Materials Disposition
OH	overhead
OPC	other project cost
PA	protected area
PC	performance category
PDCF	Pit Disassembly and Conversion Facility
PDP	Performance Demonstration Program
PDRP	project design requirements document
PEIS	programmatic environmental impact statement
PEP	project execution plan

PF	profit
PHA	preliminary hazards analysis
PIDAS	perimeter intrusion detection and assessment system
PM	project manager
PPA	property protection area
PQMP	project quality management plan
PRA	probabilistic risk analysis
QA	quality assurance
RA	radiation area
RCRA	Resource Conservation Recovery Act
RCT	radiation control technician
R&D	research and development
ROD	record of decision
SA	security area
SARP	safety analysis report for packaging
SAR	Safety analysis report/source
SC	subcontract
SCC	structure, system, and component
SEM	scanning electron microscope
SF	subcontractor management
SGS	segmented gamma-ray scanner
SMACNA	Sheet Metal and Conditioning Contractors National Association
SNM	special nuclear material
SPD	surplus plutonium disposition
SPD EIS	Surplus Plutonium Disposition Environmental Impact Statement
SRIDS	standards and requirements identification document
SRL	special recovery line
SRS	Savannah River Site
SSCs	safety systems, structures, and components
S&S	safeguards and security
SST	secure safe transport
TAN	Test Area North (INEEL, ID)
TCLP	toxic characteristic leach procedures
TEC	total estimated cost
TID	tamper-indicating device
TIG	tungsten inert gas welding

TPC	total project cost
TRA	technical risk analysis
TRU	transuranic
TRUPACT	transuranic waste package transporter
TSCM	technical security countermeasures
UBC	Uniform Building Code
UCRL	University of California Research Laboratory
UPS	uninterruptible power system
UV	ultraviolet
VIS	visible (light spectra)
WAC	waste acceptance criteria
WBS	work breakdown structure
WIPP	Waste Isolation Pilot Plant
ZPPR	Zero Power Physics Reactor (INEEL, ID)

UNITS OF MEASURE (ABBREVIATIONS)

Aampere
atm.....atmosphere
°Cdegree Celsius
cmcentimeter
dpmdisintegration per minute
°Fdegree Fahrenheit
ftfoot
gal.....gallon
ggram
hhour
hahectare
Hzhertz
in.inch
in. WG.....inch water gauge
kgkilogram
kVA.....kilovolt-ampere
kW.....kilowatt
Lliter
lbpound
mmeter
mcf1000 cubic feet
minminute
mphmiles per hour
mrem1/1000 rem
µgmicrogram
psipounds per square inch
ppmparts per million
remroentgen equivalent man
ssecond
Vvolt
Vacvolt, alternating current

Vdc.....volt, direct current

ydyard

yryear

Appendix A
Major Rules, Regulations, Codes, Guidelines,
and Standards Impacting the PDCF

**MAJOR RULES, REGULATIONS, CODES, GUIDELINES,
AND STANDARDS IMPACTING THE PDCF**

Functional Area	DOE Order, CFR Number, or Standard Identification¹	Title
Code of Federal Regulations (CFR)		
SNM Accountability	10 CFR 70	Domestic Licensing of Special Nuclear Materials
Packaging and Transportation	10 CFR 71	Packaging and Transportation of Radioactive Material
SNM Accountability	10 CFR 74	Material Control And Accounting Of Special Nuclear Material
IAEA and NRC requirements	10 CFR 75	Safeguards On Nuclear Material-Implementation Of US/IAEA Agreement
Quality Assurance	10 CFR 820	Procedural Rules for DOE Nuclear Activities
Safety	10 CFR 830	Nuclear Safety Management
Radiation Protection	10 CFR 835	Occupational Radiation Protection
Environmental Protection	10 CFR 1021	National Environmental Policy Act Implementation
Worker Safety	29 CFR 1910	Occupational Safety and Health
Air Quality	40 CFR 61	National Emission Standards for Hazardous Air Pollutants
Water Quality	40 CFR 110-122	EPA Administered Permit Programs: The National Pollution Discharge Elimination System
Radiation Protection	40 CFR 191	Environmental Radiation Protection Standards for Management and Disposal of Spent Nuclear Fuels, High-level, and Transuranic Waste
Waste Management	40 CFR 260-266	Hazardous Waste Management Systems
Waste Management	40 CFR 268	Land Disposal Restrictions
Environmental Protection	40 CFR 1500-1508	Council on Environmental Quality (CEQ) Regulations
Material Protection	41 CFR 101	Federal Property Management Regulations
Packaging and Transportation	49 CFR 173	General Requirements for Shipment and Packaging

Functional Area	DOE Order, CFR Number, or Standard Identification	Title
DOE Orders – New Series Directives		
Accident Response	DOE O 151.1	Comprehensive Emergency Management
Occurrence Reporting and Records	DOE O 232.1A	Occurrence Reporting and Processing of Operations Information
Facility Safety	DOE O 420.1	Facility Safety
Project Planning	DOE O 430.1	Lifecycle Asset Management
Energy and Water Conservation	DOE O 430.2	In-house Energy Management
Worker Safety	DOE O 440.1	Worker Protection Management for DOE Federal and Contractor Employees
Environmental Protection	DOE O 451.1A	National Environmental Policy Act Compliance Program
Packaging and Transportation	DOE O 460.1A	Packaging and Transportation Safety
Safeguards and Security	DOE O 470.1	Safeguards and Security Program
Safeguards and Security	DOE O 471.2A	Information Security Program
Safeguards and Security	DOE O 472.1B	Personnel Security Activities
DOE Orders – Old Series Directives⁴		
Safeguards and Security	DOE-1270.2B	Safeguards Agreement with the International Atomic Energy Agency
Quality Assurance	DOE-1300.2A	Department of Energy Technical Standards Program
Safeguards and Security	DOE-1360.2B	Unclassified Computer Security Program
Management Systems	DOE 1324.2B	Records Management
Packaging and Transportation	DOE-1540.2	Hazardous Material Packaging for Transport-Administrative Procedures
Packaging and Transportation	DOE-1540.3A	Base Technology for Radioactive Material Transportation Packaging Systems
Management Systems	DOE-4700.1	Project Management Systems
Emergency Management	DOE-5000.3B	Occurrence Reporting and Processing of Operations Information
Environmental Protection	DOE-5400.1	General Environmental Protection Program
Public Radiation Exposure	DOE-5400.5	Radiation Protection of the Public and Environment
Environmental Protection	DOE-5440.1E	National Environmental Policy Act Compliance Program

Functional Area	DOE Order, CFR Number, or Standard Identification	Title
DOE Orders – Old Series Directives² (continued)		
Packaging and Transportation	DOE-5480.3	Safety Requirements for the Packaging and Transportation of Hazardous Materials, Hazardous Substances, and Hazardous Wastes
Environmental Protection	DOE-5480.4	Environmental Protection, Safety, And Health Protection Standards
Fire Protection	DOE-5480.7A	Fire Protection
Occupational Safety and Health	DOE-5480.8A	Contractor Occupational Medical Program
Occupational Safety and Health	DOE-5480.9A	Construction Safety and Health Program
Occupational Safety and Health	DOE-5480.10	Contractor Industrial Hygiene Program
Radiation Protection	DOE-5480.15	Department of Energy Laboratory Accreditation Program for Personnel Dosimetry
Operations	DOE-5480.19	Conduct of Operations Requirements for DOE Facilities
Training and Qualifications	DOE-5480.20	Personnel Selection, Qualification, Training, and Staffing Requirements at DOE Reactor and Nonreactor Nuclear Facilities
Nuclear Safety	DOE-5480.21	Unreviewed Safety Questions
Nuclear Safety	DOE-5480.22	Technical Safety Requirements
Nuclear Safety	DOE-5480.23	Nuclear Safety Analysis Reports
Nuclear Safety	DOE-5480.24	Nuclear Criticality Safety
Management Systems	DOE-5480.26	Trending and Analysis of Operations Information Using Performance Indicators
Engineering Program	DOE-5480.28	Natural Phenomena Hazards Mitigation
Occupational Safety and Health	DOE-5483.1A	Occupational Safety and Health Program for Department of Energy Contractor Employees at Government-Owned Contractor-Operated Facilities
Occupational Safety and Health	DOE-5484.1	Environmental Protection, Safety and Health Protection Information Reporting Requirements
Emergency Management	DOE-5500.1B	Emergency Management System
Emergency Management	DOE-5500.2B	Emergency Categories, Classes and Notification and Reporting Requirements
Public Radiation Exposure	DOE-5500.3A	Planning and Preparedness for Operational Emergencies
Emergency Management	DOE-5500.4A	Public Affairs Policy and Planning Requirements for Emergencies
Emergency Management	DOE-5500.7B	Emergency Operating Records Protection Program
Emergency Management	DOE-5500.10	Emergency Readiness Assurance Program

Functional Area	DOE Order, CFR Number, or Standard Identification	Title
DOE Orders – Old Series Directives² (continued)		
Safeguards and Security	DOE-5610.2	Control of Weapons Data
Packaging and Transportation	DOE-5610.12	Packaging and Off-site Transportation of Nuclear Components, and Special Assemblies Associated with the Nuclear Explosives and Weapons Safety Program
Safeguards and Security	DOE-5610.14	Transportation Safeguards System Program Operations
Safeguards and Security	DOE-5631.6A	Personnel Security Assurance Program
Safeguards and Security	DOE-5632.1C	Protection and Control of Safeguards and Security Interests
Safeguards and Security	DOE-5633.3B	Control and Accountability of Nuclear Materials
Safeguards and Security	DOE-5639.1	Information Security Program
Safeguards and Security	DOE-5639.5	Technical Surveillance Countermeasures
Safeguards and Security	DOE-5639.6A	Classified Automated Information System Security Program
Safeguards and Security	DOE-5639.7	Operations Security Program
Safeguards and Security	DOE-5650.2B	Identification of Classified Information
Quality Assurance	DOE 5700.6C	Quality Assurance
Waste Management	DOE-5820.2A	Radioactive Waste Management
Other Standards and Guidance that Significantly or Uniquely Impact the Design of the PDCF³		
Product Quality and Packaging	DOE STD 3013-96	Criteria for Preparing and Packaging Plutonium Metal and Oxides for Long-term Storage
Product Quality	ASTM C 757-90	American Society for Testing and Materials: Standard Specifications for Nuclear-grade Plutonium Dioxide, Sinterable
Product Quality	ASTM C 833-86	American Society for Testing and Materials: Standard Specifications for Sintered Uranium-plutonium Pellets
Radiation Protection	DOE/EH-0256T Rev. 1	DOE Radiological Control Manual
Safeguards and Security	IAEA INFCIRC/288	Agreement Between the United States of America and the International Atomic Energy Agency for the Application of Safeguards in the United States of America
Waste Management	WIPP-DOE-069, Rev 5	TRU Waste Acceptance Criteria for the Waste Isolation Pilot Plant

Notes:

¹Standard construction codes and standards are not included separately on this list. Codes referenced by DOE orders apply to the project. The facility will be subject to local building codes that are imposed at the DOE site selected for the facility.

²There is some overlap between the new series DOE orders and the old series. Some old series orders listed have been canceled by new series orders, but are listed because the old orders are still listed on current DOE databases.

³“Other Standards and Guidance” includes a select listing of those items found during the scoping and preconceptual design of the facility to have significant or unique impacts to the PDCF. Other standards and guidance as cited by DOE orders apply, but are not listed because their application is inferred by listing the DOE order.

Appendix B
Conceptual Design Drawings

DRAWING TITL

SHEET

T01	DRAWING
G01	GENERAL
A01	ARCHITE
A02	ARCHITE
A03	ARCHITE
A04	ARCHITE
A05	NOT US
C01	CIVIL SI
E01	ELECTRI
E02	SYSTEMS
M001	BLOCK
M002	BLOCK
M003	BLOCK
M004	BLOCK
M005	BLOCK
M006	BLOCK
M007	BLOCK
M008	BLOCK
M009	BLOCK
M010	BLOCK
M011	BLOCK
M012	BLOCK
M013	BLOCK
M014	BLOCK
M015	NOT US
M016	NOT US
M017	NOT US
M018	BLOCK
M019	BLOCK
M020	NOT US
M021	NOT US
M022	BLOCK
M023	BLOCK
M024	NOT US
M101	HVAC I
M102	HVAC I
M103	HVAC I
M104	HVAC I
M105	HVAC I
M106	HVAC I
M107	HVAC I
M201	MECHA
M202	MECHA
M203	MECHA
M204	MECHA
M205	MECHA

INDEX	
	TITLE
TITLE INDEX INFORMATION	SYMBOLS, LEGENDS, ABBREVIATIONS
GENERAL FLOOR PLAN	FIRST FLOOR LEVEL
GENERAL FLOOR PLAN	BASEMENT LEVEL
GENERAL FLOOR PLAN	ROOF LEVEL
GENERAL SECTION	BUILDING SECTIONS
	--
PLAN	
DISTRIBUTION DIAG	
BLOCK DIAGRAM	SCADA & DDC
FLOW DIAGRAM	ARGON PURIFICATION SYSTEM
FLOW DIAGRAM	BOTTLED GASES
FLOW DIAGRAM	CAM/FAS SYSTEM
FLOW DIAGRAM	HYDOX REACTOR/DRY VAC
FLOW DIAGRAM	LV COOLING WATER
FLOW DIAGRAM	LIQUEFIED ARGON SYSTEM
FLOW DIAGRAM	LIQUEFIED NITROGEN
FLOW DIAGRAM	POLISHED DI WATER SYSTEM
FLOW DIAGRAM	PROCESS CHILLED WATER
FLOW DIAGRAM	TRITIUM GATHERING/REMOVAL
FLOW DIAGRAM	CHILLED WATER SYSTEM
FLOW DIAGRAM	COOLING TOWER WATER
FLOW DIAGRAM	EMERGENCY/ STANDBY GEN
FLOW DIAGRAM	FIRE WATER SYSTEM
	--
	--
	--
FLOW DIAGRAM	PLANT/INSTR/BREATH AIR
FLOW DIAGRAM	POTABLE HOT WATER
	--
	--
FLOW DIAGRAM	SULFURIC ACID REC & STOR
FLOW DIAGRAM	UTILITY WASTE WATER
	--
FLOW DIAGRAM	MATERIAL ACCESS AREAS
FLOW DIAGRAM	MATERIAL ACCESS AREAS
FLOW DIAGRAM	WASTE MANAGEMENT AREAS
FLOW DIAGRAM	MISCELLANEOUS AREAS
CONFINEMENT ZONES	FIRST FLOOR LEVEL
CONFINEMENT ZONES	BASEMENT LEVEL
CONFINEMENT ZONES	ROOF LEVEL
EQUIPMENT PLAN	BASEMENT - NORTH
EQUIPMENT PLAN	BASEMENT - SOUTH
EQUIPMENT PLAN	FIRST FLOOR SOUTH
EQUIPMENT PLAN	FIRST FLOOR NORTH
EQUIPMENT PLAN	FIRST FLOOR WEST



FLUOR DANIEL INC

PIT DISSASSEMBLY &
CONVERSION FACILITY
CONCEPTUAL DESIGN

DRAWING INDEX

T01

REFERENCE BUILDING

Los Alamos Los Alamos National Laboratory
Los Alamos, New Mexico 87545

PI: DATE: 11-01-97 PL

HVAC SYMBOLS LEGEND

SYMBOL	DESCRIPTION
	AIR FLOW DIRECTION
	DAMPER
	AIR HANDLING UNIT/ AIR CONDITIONING UNIT
	FAN
	FILTER
	HEATING COIL
	COOLING COIL
	CONFINEMENT ZONE (EQUIPMENT)
	HEPA FILTER

ARCHITECTURAL SYMBOLS LEGEND

SYMBOL	DESCRIPTION
	SECTION LETTER DRAWING NUMBER WHERE SECTION IS SHOWN
	DETAIL NUMBER DRAWING NUMBER WHERE DETAIL WAS TAKEN
	COLUMN LINE
	MAA BOUNDARY
	PARTITION/EXTERIOR WALL
	STAIR
	ELEVATOR/EQUIPMENT LIFT

ELECTRICAL SYMBOLS LEGEND

SYMBOL	DESCRIPTION
	FUSE
	CURRENT TRANSFORMER
	POTENTIAL TRANSFORMER
	DRAWCUT CIRCUIT BREAKER
	SURGE ARRESTER
	DISCONNECT SWITCH
	TRANSFORMER (DELTA-WYE CONN.)
	CIRCUIT BREAKER (TRIP FRAME)
	CONNECTION
	NO CONNECTION
	GROUND
	GENERATOR
	VOLTMETER SWITCH
	VOLTMETER
	AMMETER
	WATTMETER
	AMMETER SWITCH
	KEY INTERLOCK

ABBREVIATIO

A
 AAM
 ACC
 ACCU
 AFF
 AFP
 AG.GB
 Ar
 ATM
 ATS
 BUS
 BMS
 C
 CoClz
 CAS
 CAM
 CC
 CCTV
 CCWR
 CCWS
 CFM
 C12
 DEMUX
 DI
 DIAG & MAINT
 DTD
 EMERG
 EOC
 EXP
 FAS
 FAP
 FDDI
 F.H.
 G.B.
 GEN
 H2
 H2SU4
 HC
 He
 HEPA
 HF
 HGU
 IA
 KW
 KVA
 LLW
 LVCW
 MC&A
 MCC
 MM
 MUX
 NC
 NDA
 NO
 N2
 Oz
 OA
 O.F.G.B.

S

ALARM
 ALTERNATE ALARM MONITORING
 ARGUS COMMUNICATIONS CONCENTRATOR
 AIR COOLED CONDENSING UNIT
 ABOVE FINISHED FLOOR
 ARGUS FIELD PROCESSOR
 ARGON GLOVE BOX
 ARGON
 ATMOSPHERE
 AUTOMATIC TRANSFER SWITCH
 BUSS BAR
 BALANCED MAGNETIC SWITCH
 CONTROL
 CALCIUM CHLORIDE
 CENTRAL ALARM STATION
 CONTINUOUS AIR MONITOR
 COOLING COIL
 CLOSED CIRCUIT TELEVISION
 CENTRAL CHILLED WATER RETURN
 CENTRAL CHILLED WATER SUPPLY
 CUBIC FEET PER MINUTE
 CHLORINE
 DE-MULTIPLEXER
 DEIONIZED
 DIAGNOSTIC & MAINTENANCE
 DUAL-TECHNOLOGY MOTION DETECTOR
 EMERGENCY
 EMERGENCY OPERATING CENTER
 EXPANSION CABINET
 FIXED HEAD AIR SAMPLER
 FIRE ALARM PANEL
 FIBER OPTIC PROTOCOL
 FUME HOOD
 GLOVE BOX
 GENERATOR
 HYDROGEN
 SULFURIC ACID
 HEATING COIL
 HELIUM
 HIGH-EFFICIENCY PARTICULATE AIR
 HEPA FILTER
 HAND GEOMETRY UNIT
 INSTRUMENT AIR
 KILO-WATTS
 KILO VOLT AMPS
 LOW LEVER WASTE
 LIMITED VOLUME COOLING WATER
 MATERIAL CONTROL AND/OR ACCOUNTABILITY
 MOTOR CONTROL CENTER
 MULTIMODE FIBER
 MULTIPLEXER
 NORMALLY CLOSED
 NON-DESTRUCTIVE ASSAY
 NORMALLY OPEN
 NITROGEN
 OXYGEN
 OUTSIDE AIR
 OPEN FRONT GLOVE BOX

ABBREVIATIONS CONT.

PA	PLANT AIR
PCW	POTABLE COLD WATER
PCWS	PROCESS CHILLED WATER SUPPLY
PCWR	PROCESS CHILLED WATER RETURN
PF	POWER FACTOR
PHW	POTABLE HOT WATER
PIDAS	PERIMETER INTRUSION DETECTION AND ASSESSMENT SYSTEM
PRI	PRIMARY
PTR	PRINTER
P-10	P-10 GAS (90%AR10%METHANE)
RA	RETURN AIR
RAP	REMOTE ACCESS PANEL
REGEN	REGENERATION GAS (96%AR,4%H2)
RECIRC	RECIRCULATION
S	STATUS
SCADA	SUPERVISORY CONTROL & DATA ACQUISITION
SA	SUPPLY AIR
SAS	SECONDARY ALARM STATION
SEC	SECONDARY
SRT	SPECIAL RESPONSE TEAM
SW	SWITCH
SWGR	SWITCHGEAR
TAP	TAP FOR SAMPLING AIR
TWR	COOLING TOWER WATER RETURN
TWS	COOLING TOWER WATER SUPPLY
TYP	TYPICAL
UAC	UNSTAFFED ASSESSMENT CONSOLE
UC	UNDERCUT
UDA	VIDEO DISTRIBUTION AMPLIFIER (COPPER)
UPS	UNINTERRUPTIBLE POWER SUPPLY
V	VOLT
VAC	PROCESS VACUUM
VDA	VIDEO DISTRIBUTION AMPLIFIER (FIBER)
WP	WEATHERPROOF
WS	WEIGHT SCALE



FLUOR DANIEL INC

PIT DISSASSEMBLY & CONVERSION FACILITY CONCEPTUAL DESIGN

SYMBOLS, LEGENDS,
 AND ABBREVIATIONS

G01

REFERENCE BUILDING

Los Alamos Los Alamos National Laboratory
 Los Alamos, New Mexico 87545

PI: DATE: 11-01-97 PL

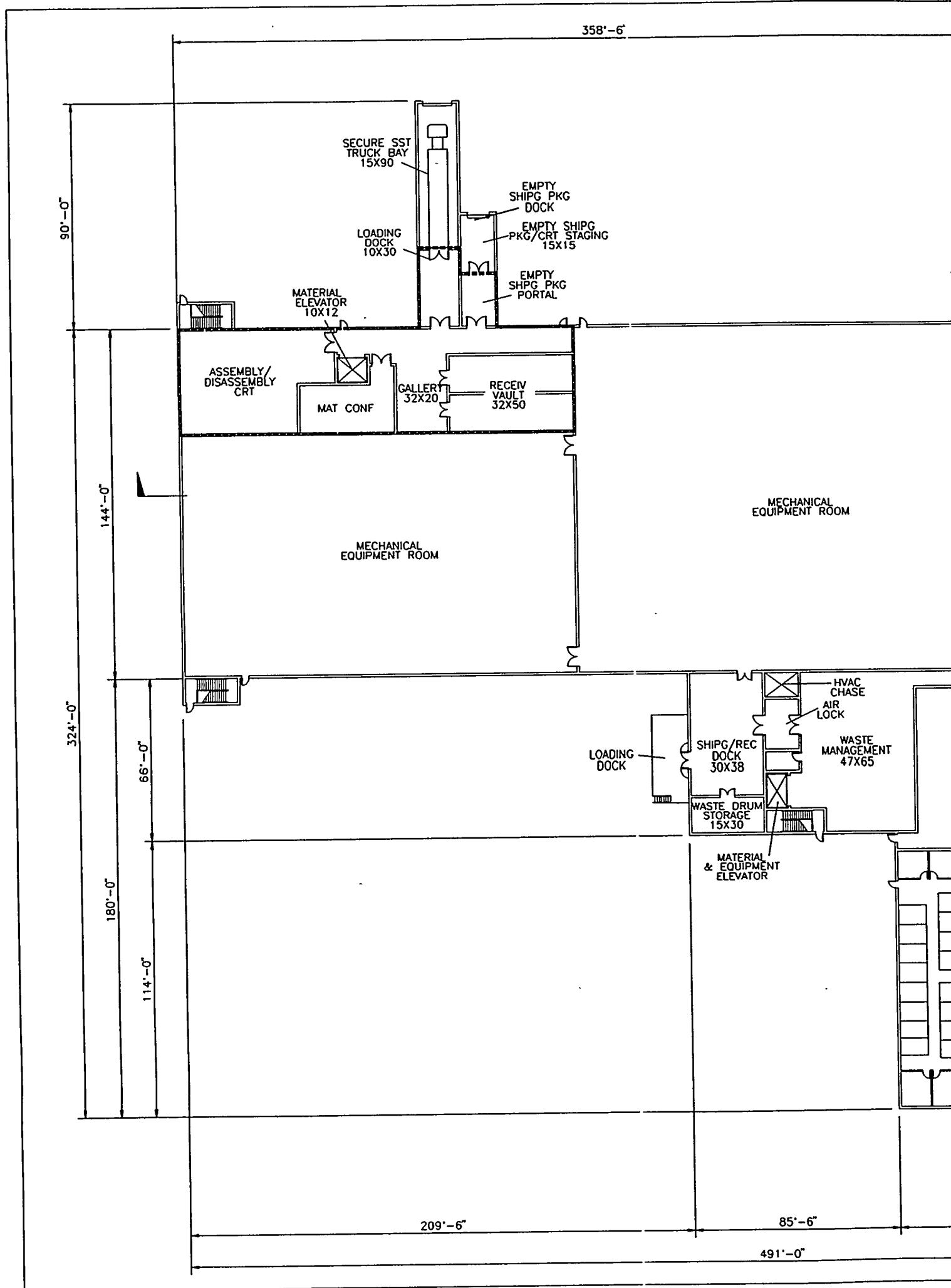

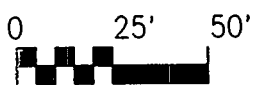
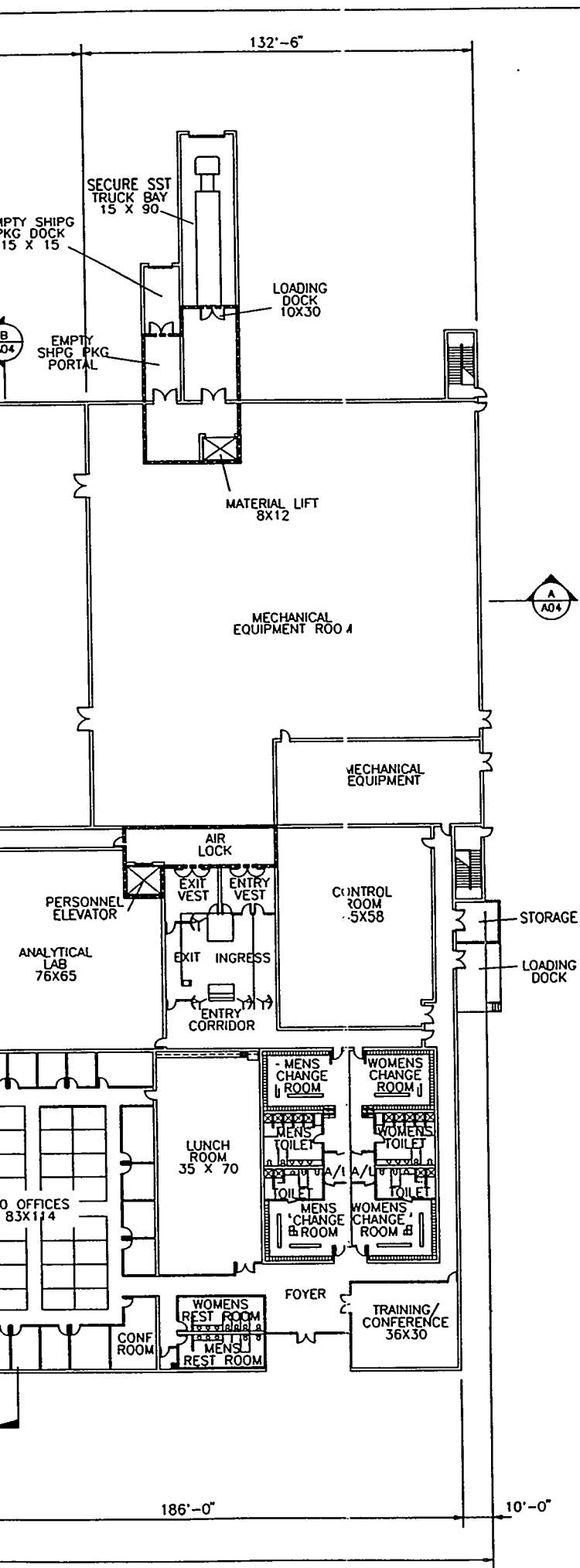

FLUOR DANIEL INC

PIT DISSASSEMBLY &
 CONVERSION FACILITY
 CONCEPTUAL DESIGN

ARCHITECTURAL FLOOR PLAN A01
 FIRST FLOOR LEVEL

REFERENCE BUILDING

Los Alamos Los Alamos National Laboratory
 Los Alamos, New Mexico 87545

PI: DATE: 11-01-97 PL

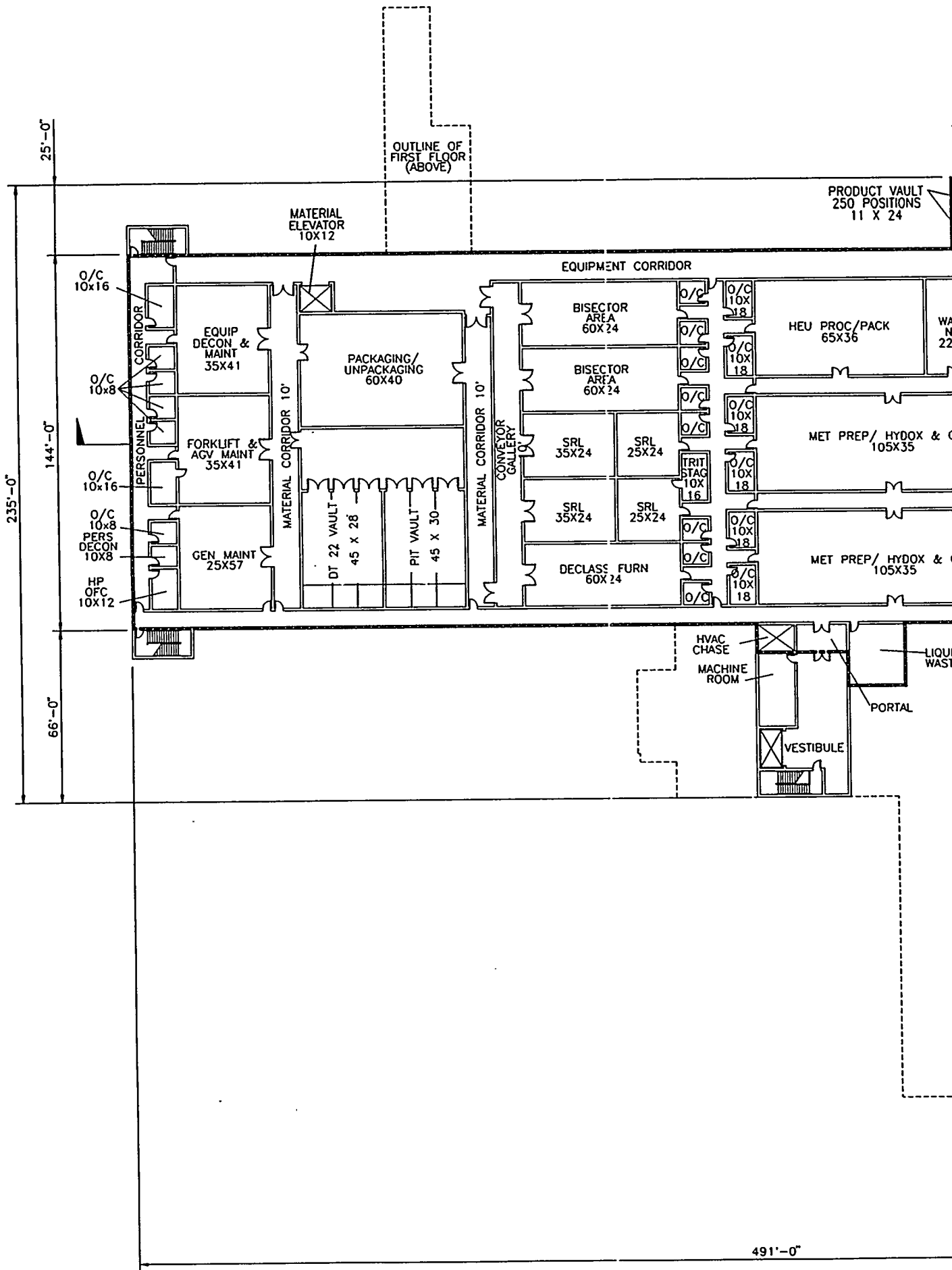

CLASSIFIED UNCLASSIFIED

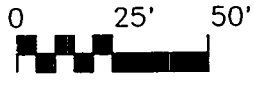
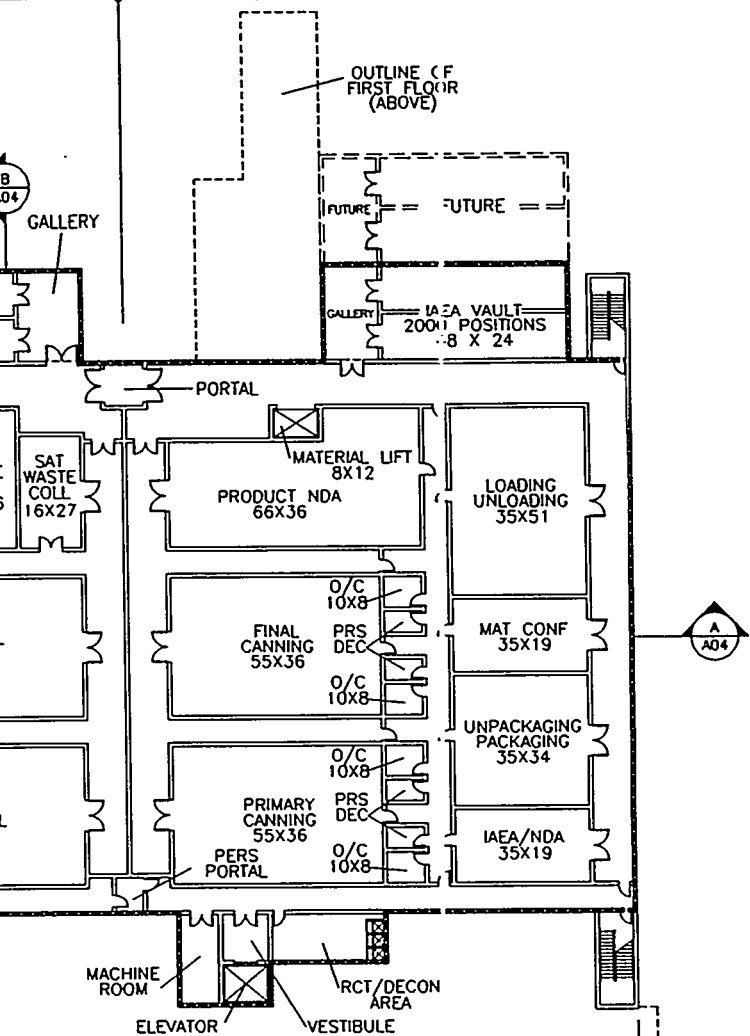

FLUOR DANIEL INC

PIT DISSASSEMBLY &
CONVERSION FACILITY
CONCEPTUAL DESIGN

ARCHITECTURAL FLOOR PLAN
BASEMENT LEVEL

A02

REFERENCE BUILDING

Los Alamos Los Alamos National Laboratory
Los Alamos, New Mexico 87545

PI: DATE: 11-01-97 PL

OUTLINE OF
FIRST FLOOR
(ABOVE)

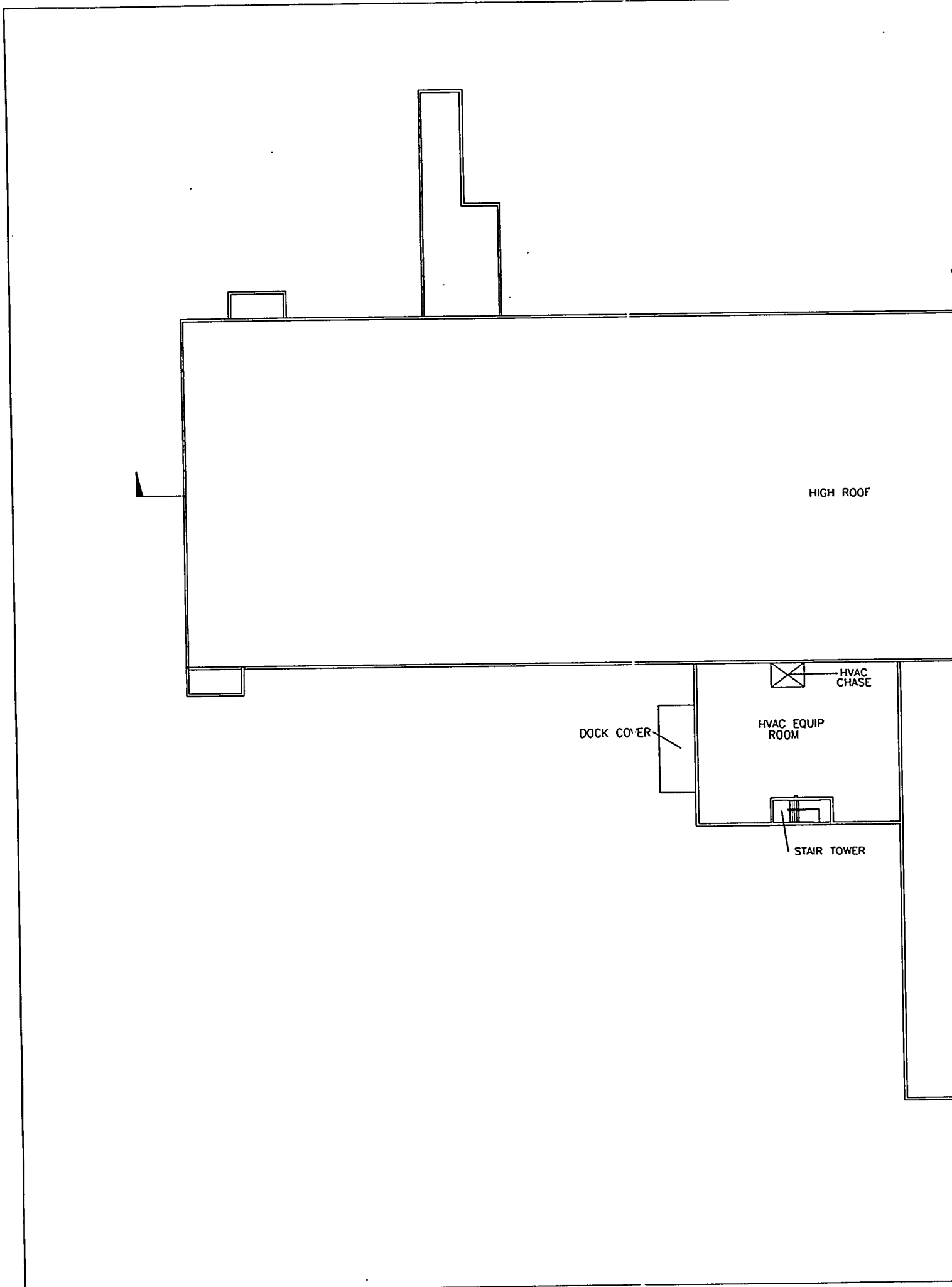

HIGH ROOF

DOCK COVER

HVAC CHASE

HVAC EQUIP ROOM

STAIR TOWER

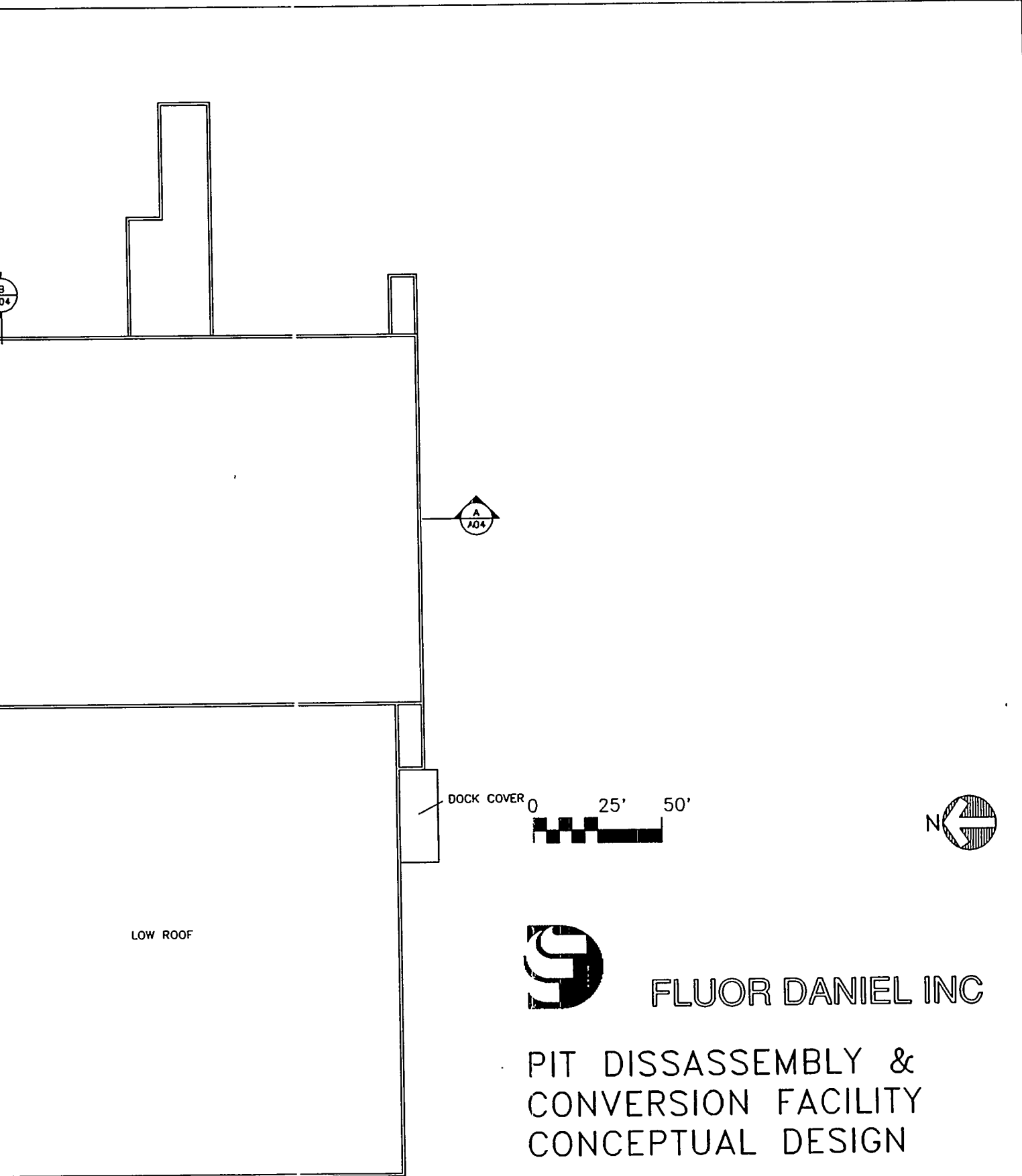

LOW ROOF

DOCK COVER

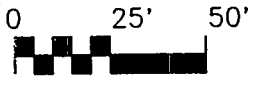

FLUOR DANIEL INC

PIT DISSASSEMBLY &
CONVERSION FACILITY
CONCEPTUAL DESIGN

ARCHITECTURAL FLOOR PLAN
ROOF LEVEL

A03

REFERENCE BUILDING

Los Alamos Los Alamos National Laboratory
Los Alamos, New Mexico 87545

PI: DATE: 11-01-97 PL

29'-0" PARAPET

27'-0" ROOF

0'-0"

-26'-0"

PERSONNEL CORRIDOR

FORKLIFT MAINT

VAULT

MECHANICAL EQUIPMENT ROOM

SRL AREA

SRL AREA

METAL PREP HYDOX & GALLIUM

OFFICE OR CONTROL AREA

MATERIAL CORRIDOR

MATERIAL CORRIDOR

CONVEYOR GALLERY

OFFICE OR CONTROL AREA

SECTION A
SCALE: NOT TO SCALE

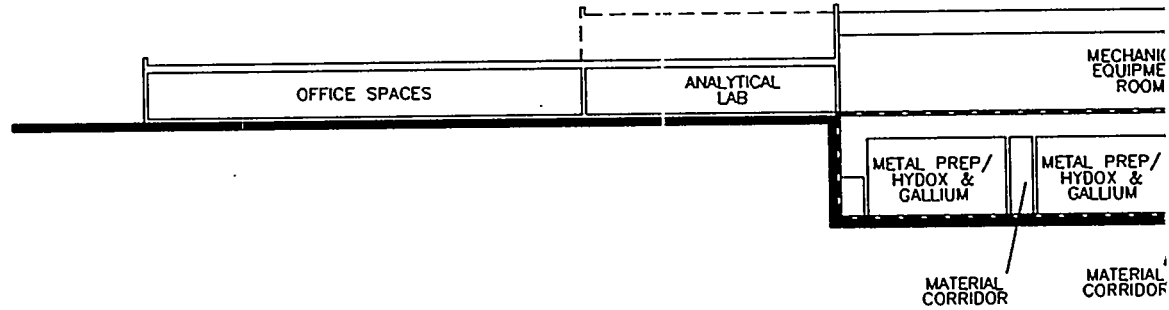

SECTION B
SCALE: NOT TO SCALE

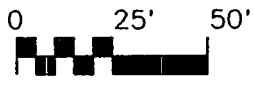
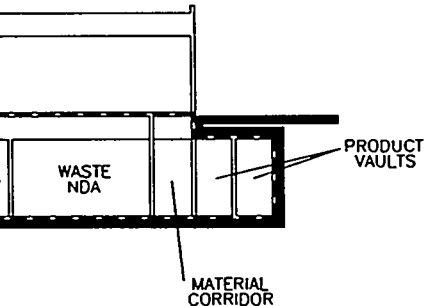
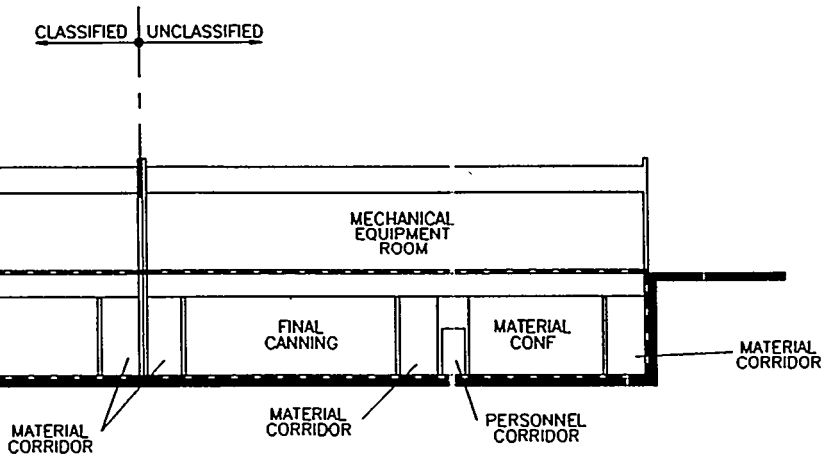

FLUOR DANIEL INC

PIT DISSASSEMBLY &
 CONVERSION FACILITY
 CONCEPTUAL DESIGN

ARCHITECTURAL SECTION
 BUILDING SECTIONS

A04

REFERENCE BUILDING

Los Alamos Los Alamos National Laboratory
 Los Alamos, New Mexico 87545

PI: DATE: 11-01-97 PL

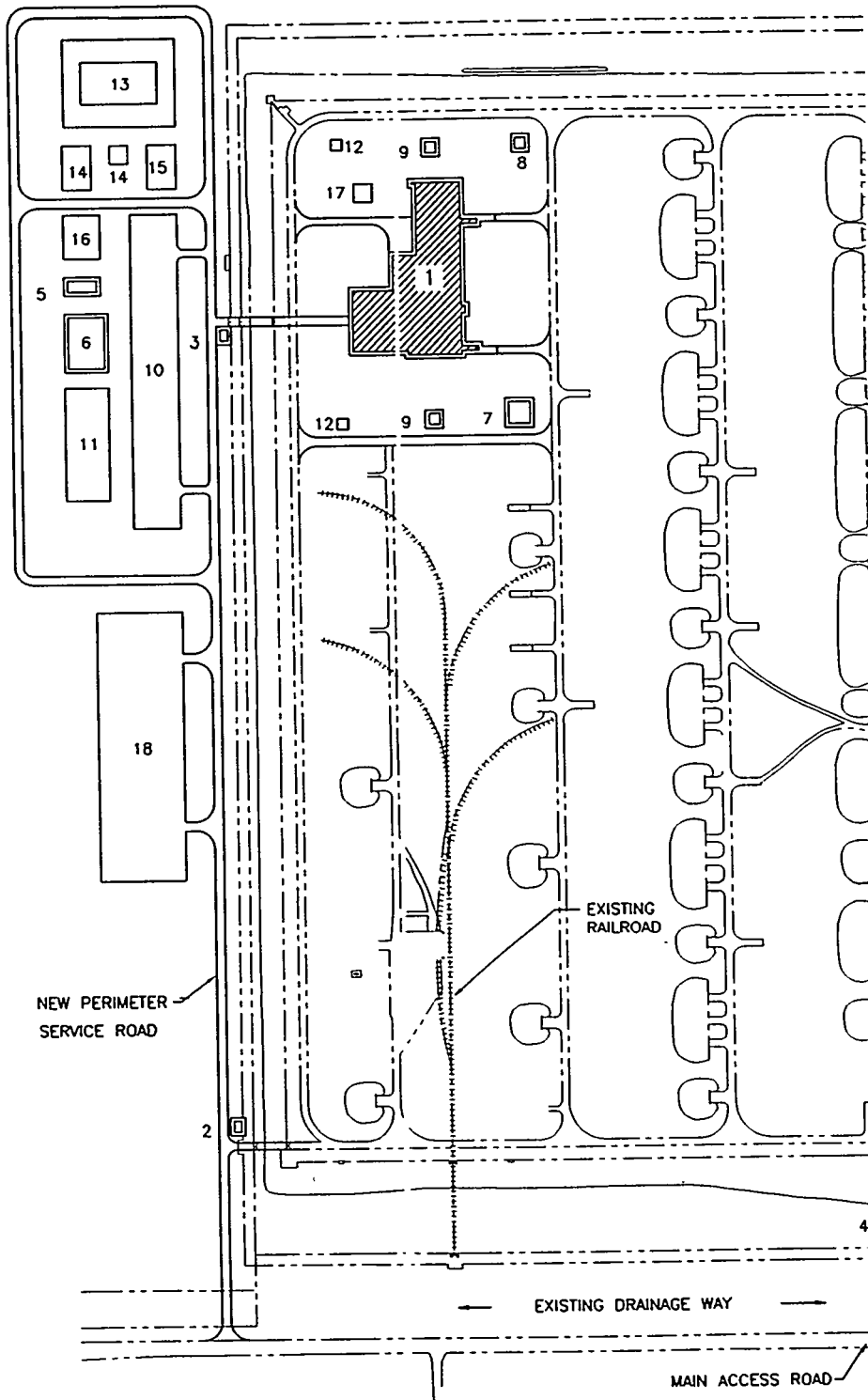

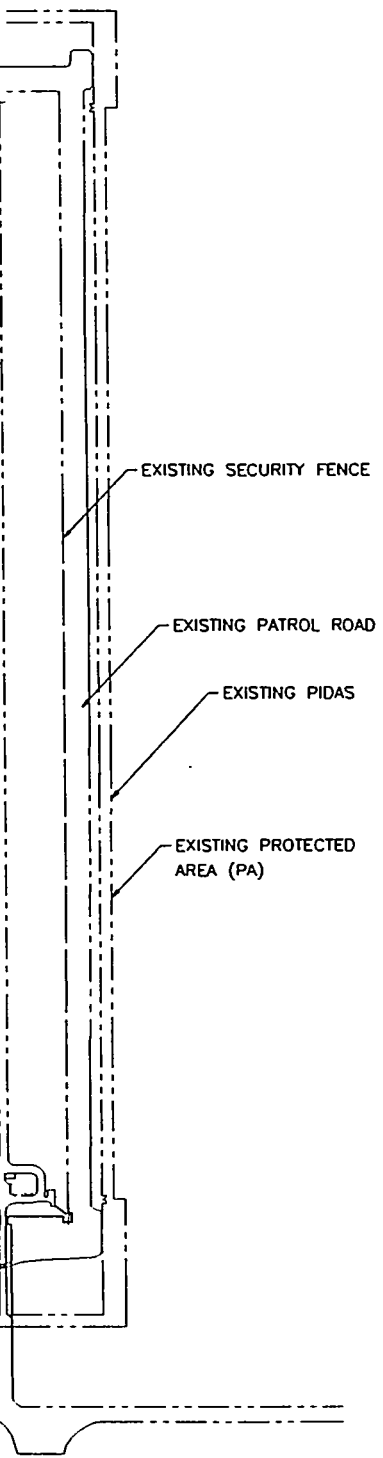



NEW FACILITIES

- 1 PDCF BUILDING
- 2 SECURITY PORTAL - PA/VEHICLE
- 3 SECURITY PORTAL - PA/PEDESTRIAN
- 4 SECURITY PORTAL - PA/SST
- 5 WASTE STORAGE
- 6 UTILITY BUILDING
- 7 SOURCE CALIBRATION FACILITY
- 8 EMERGENCY GENERATOR
- 9 UNIT SUBSTATION [2]
- 10 PARKING
- 11 STORAGE YARD
- 12 EFFLUENT MONITORING SYSTEM/
METEOROLOGICAL TOWER [2]
- 13 SWITCHYARD
- 14 FIRE WATER STORAGE TANK/PUMPHOUSE
- 15 COOLING TOWER
- 16 DIESEL FUEL STORAGE
- 17 LIQUIFIED GAS SUPPLY
- 18 CONSTRUCTION LAYDOWN AREA

LEGEND

-  BUILDING OUTLINE [NEW]
-  AREA OUTLINE [NEW]
-  AREA OUTLINE [EXISTING]

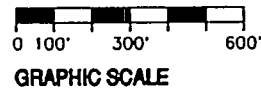

FLUOR DANIEL INC

PIT DISASSEMBLY &
CONVERSION FACILITY
CONCEPTUAL DESIGN

CIVIL SITE PLAN

C01

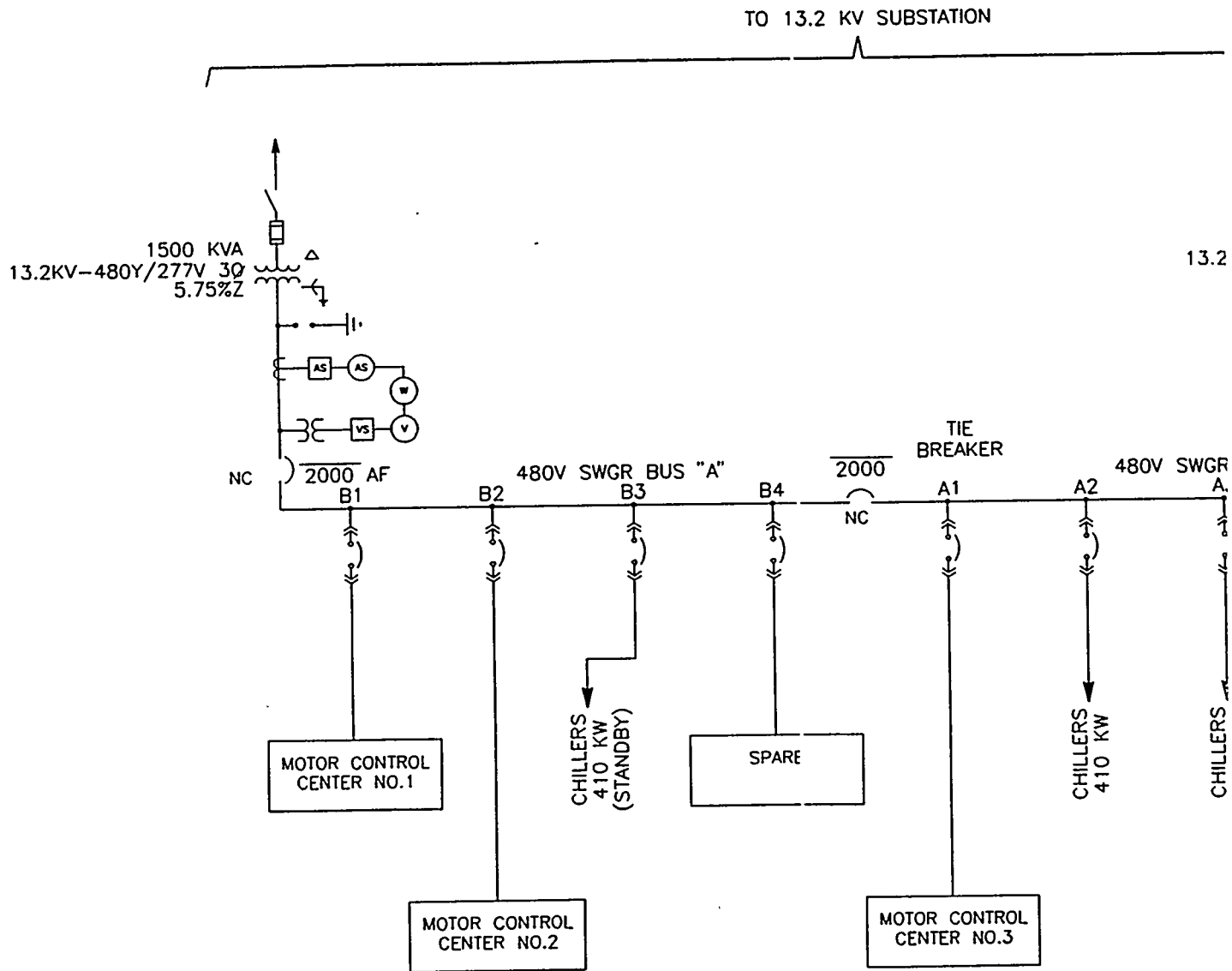

NOTES

- 1. TIE BREAKER RATED 2000AMP IS NORMALLY CLOSED

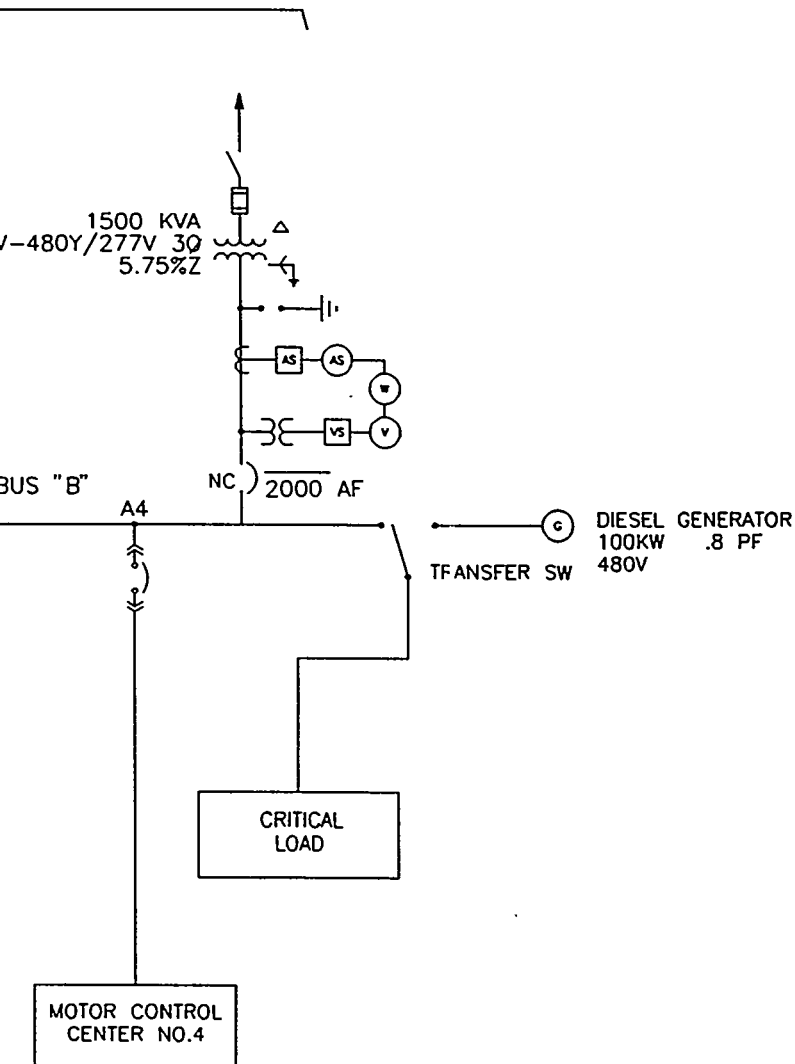

FLUOR DANIEL INC

PIT DISASSEMBLY &
CONVERSION FACILITY
CONCEPTUAL DESIGN

ELECTRICAL
DISTRIBUTION DIAGRAM

E01

REFERENCE BUILDING

Los Alamos Los Alamos National Laboratory
Los Alamos, New Mexico 87545

PI: DATE: 09-26-97 PI

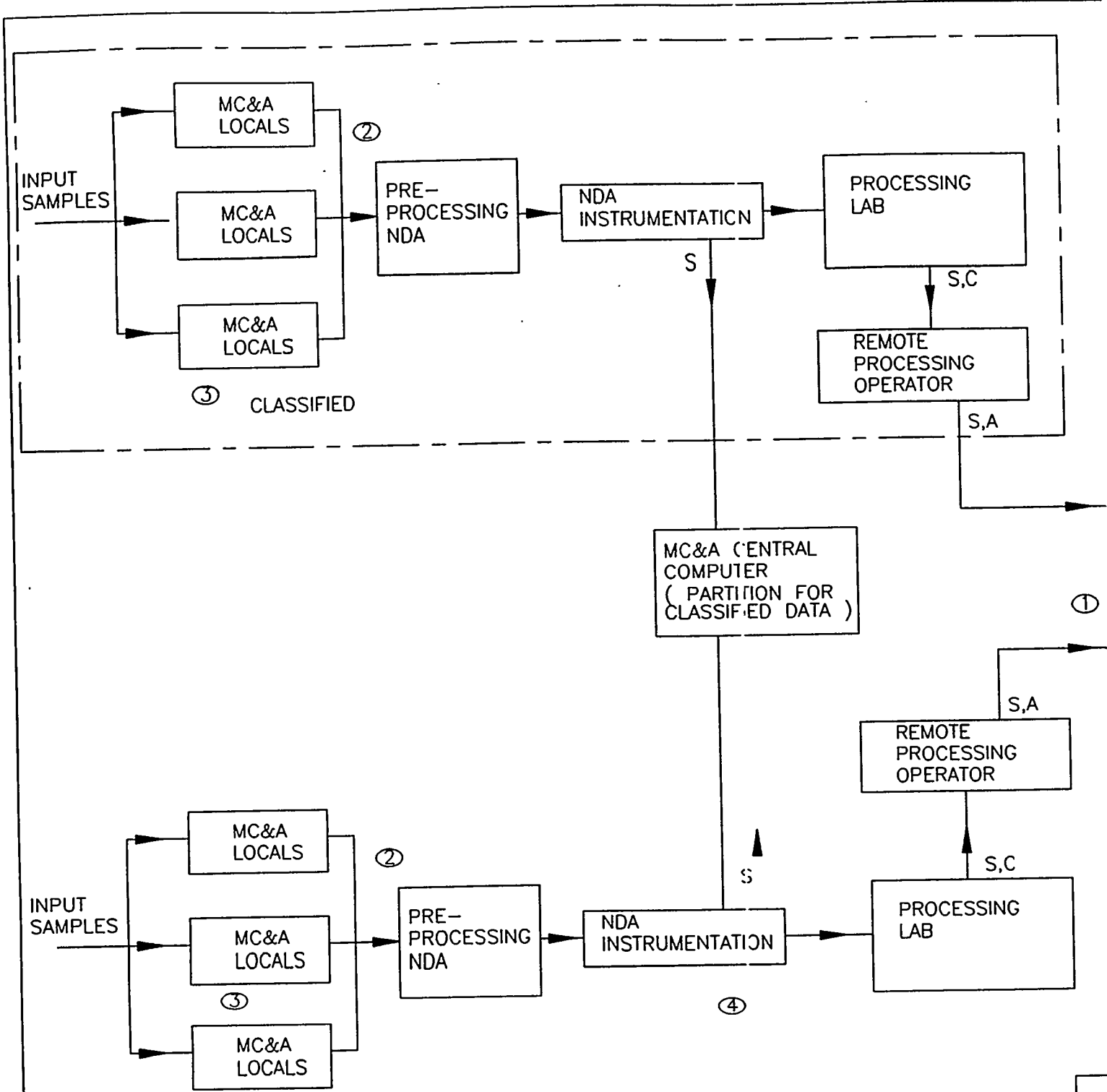

KEY NOTES:

- ① ARROWS ON LINES INDICATE DIRECTION OF POWER, INFORMATION FLOW (ALARMS -A, STATUS -S, AND CONTROL -C) SIGNALS
- ② ROBOTICS WILL BE USED WITHIN THE NDA MODULE TO TRANSFER THE INPUT COMPONENTS WITHIN THE VARIOUS ASSAY INSTRUMENTS
- ③ COMPUTERS ARE FULLY INTEGRATED INTERFACES WITH CENTRAL MC&A COMPUTER
- ④ A SEPARATE NDA SYSTEM WILL BE USED FOR UNCLASSIFIED PRODUCTS AND WASTE.

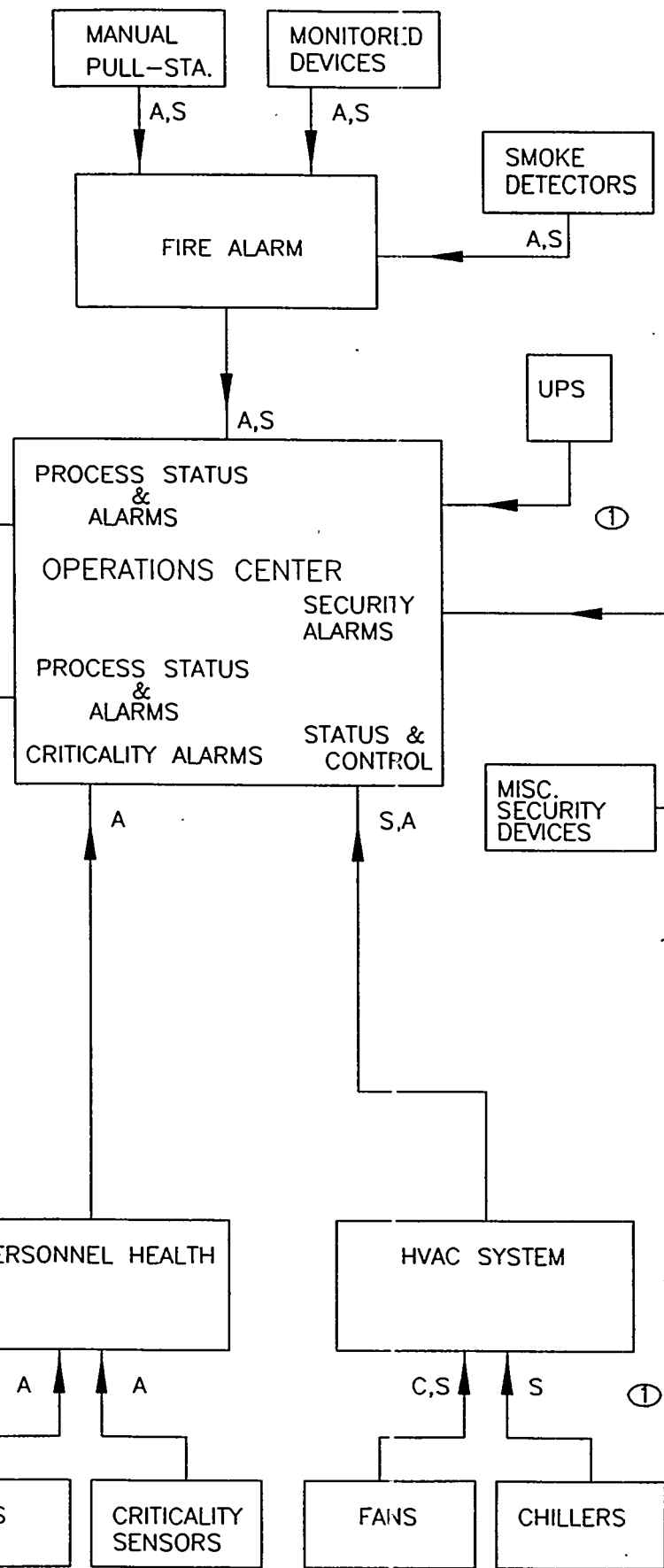

ABBREVIATIONS:

- A - ALARM SIGNAL, ELECTRONICALLY PROCESSED
- C - CONTROL SIGNAL
- CA - CAM ANNUNCIATION
- CAM - CONTINUOUS AIR MONITOR
- CCTV - CLOSED CIRCUIT TV
- DDC - DIRECT DIGITAL CONTROL
- DP- DIFFERENTIAL PRESSURE
- HP - HEALTH PHYSICS
- HVAC - HEATING VENTILATION AND AIR CONDITIONING
- LAN - LOCAL AREA NETWORK (WIRE OR WIRELESS)
- MC&A- MATERIAL CONTROL AND ACCOUNTABILITY
- OC - OPERATING CENTER
- P - POWER
- SCADA - SUPERVISORY CONTROL AND DATA ACQUISITION
- S - STATUS
- UPS - UNINTERRUPTIBLE POWER SUPPLY



FLUOR DANIEL INC

PIT DISASSEMBLY &
COVERSION FACILITY
CONCEPTUAL DESIGN

SYSTEMS BLOCK DIAGRAM
SCADA & DDC

E02

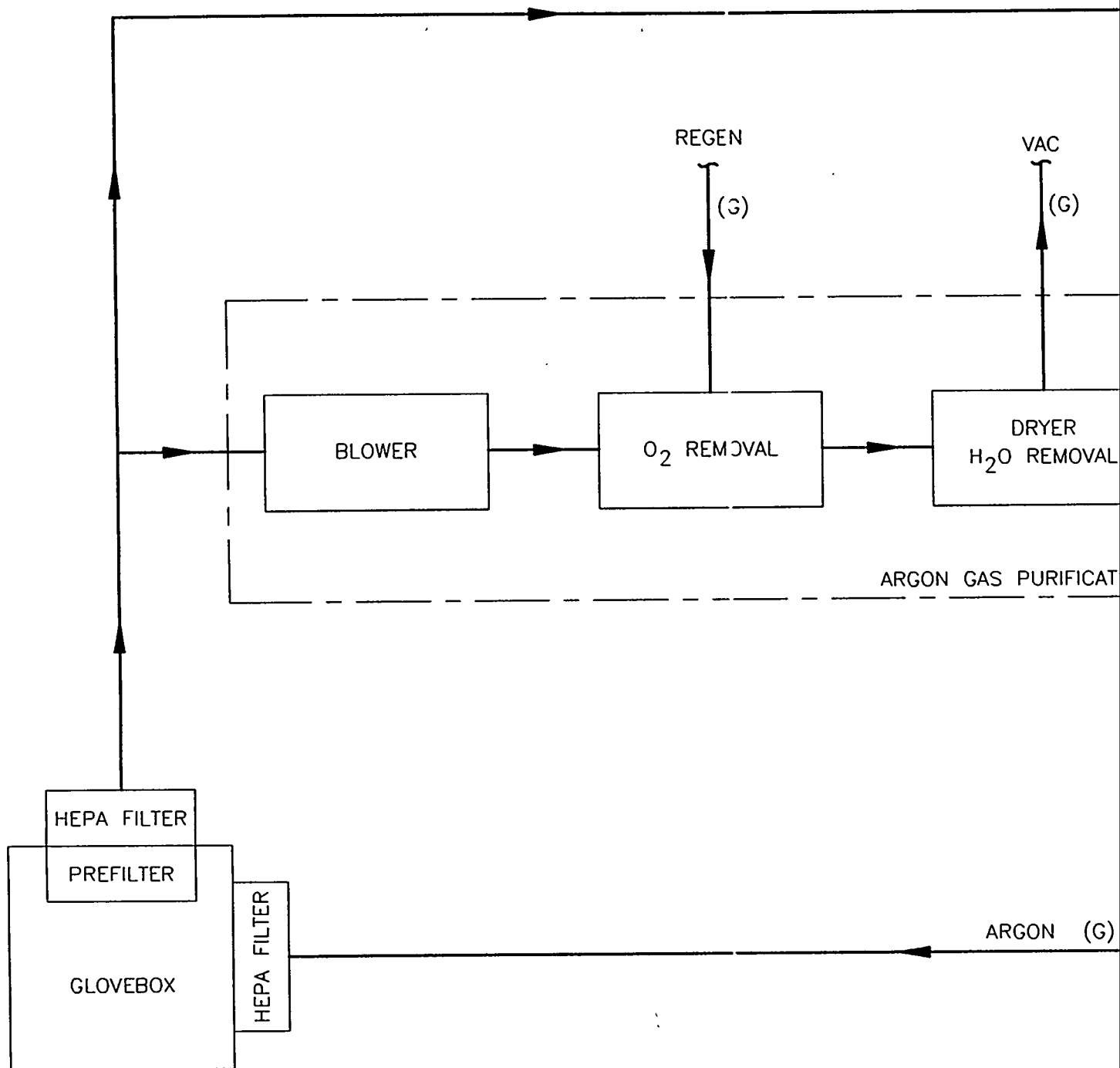

ARGON GAS PURIFICATION

ARGON (G)

LEGEND

- 1. REGEN
- 2. VAC
- 3. HEPA FILTER

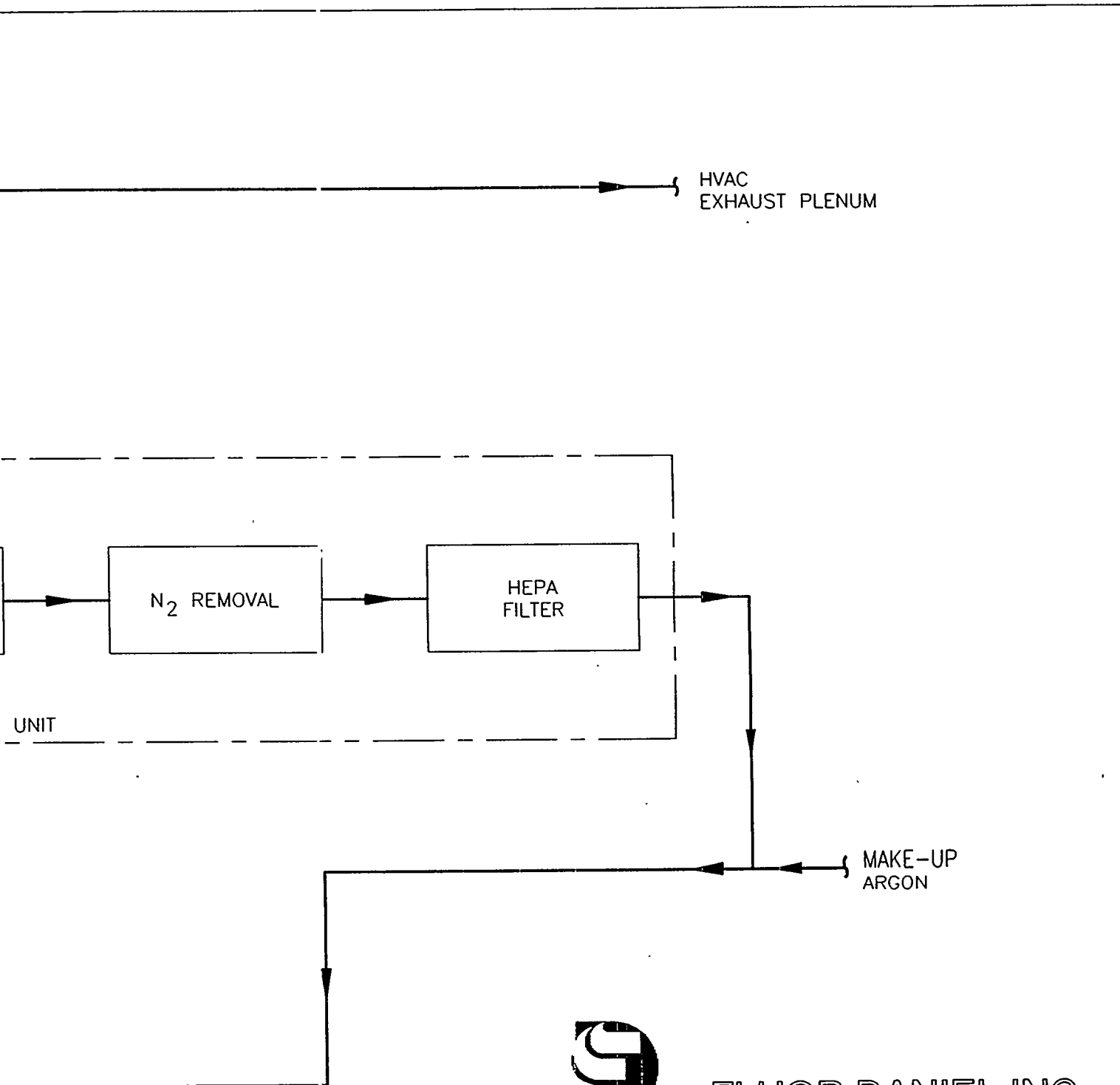

FLUOR DANIEL INC

PIT DISASSEMBLY &
 CONVERSION FACILITY
 CONCEPTUAL DESIGN

BLOCK FLOW DIAGRAM ARGON PURIFICATION SYSTEM **M001**

IN: REGENERATION GAS
 96% AR 4% METHANE
 PROCESS VACUUM
 HIGH EFFICIENCY
 PARTICULATE AIR

Los Alamos Los Alamos National Laboratory
 Los Alamos, New Mexico 87545

PI: DATE: 11-01-97 PL

OXYGEN HIGH PRESSURE
TUBE TRAILER DELIVERY

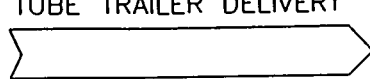

O₂ (G)



HIGH PRESSURE
TUBE TRAILER
PACKING/STORAGE



CHLORINE CYLINDER
DELIVERY



CL₂ (G)



CYLINDER STATION



P-10 CYLINDER
DELIVERY

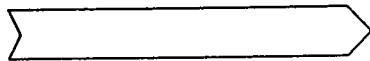

P-10 (G)



CYLINDER STATION



REGENERATION GAS
CYLINDER DELIVERY



REGEN (G)



CYLINDER STATION



HYDROGEN GAS
CYLINDER DELIVERY

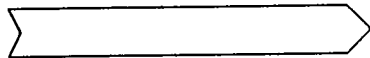

H₂ (G)



CYLINDER STATION



HELIUM GAS
CYLINDER DELIVERY

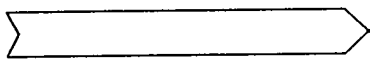

He (G)



CYLINDER STATION



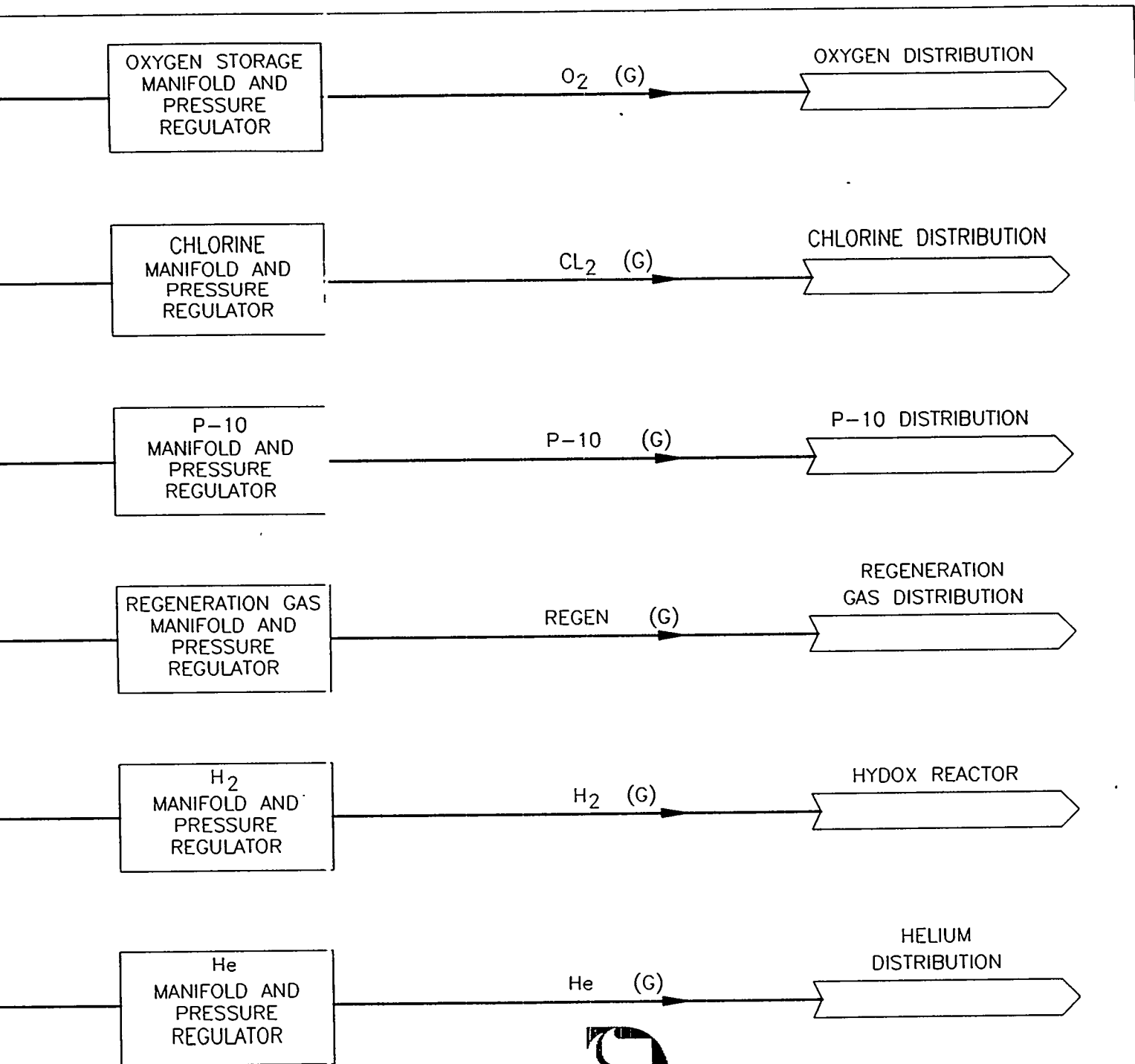

FLUOR DANIEL INC

PIT DISASSEMBLY &
 CONVERSION FACILITY
 CONCEPTUAL DESIGN

BLOCK FLOW DIAGRAM
 BOTTLED GASSES

M002

Los Alamos Los Alamos National Laboratory
 Los Alamos, New Mexico 87545

PI: DATE: 11-01-97 PL

CAM



(G)

FAS



(G)

TAP



(G)



VACUUM
BLOWER
WITH
AFTER COOLER

(G)

HVAC EXHAUST PLENUM

LEGEND:

1. CAM: CONTINUOUS AIR MONITOR
2. FAS: FIXED HEAD AIR SAMPLER
3. TAP: TAP FOR SAMPLING AIR IN
DUCTS AND FILTER PLENUMS



FLUOR DANIEL INC

PIT DISASSEMBLY &
CONVERSION FACILITY
CONCEPTUAL DESIGN

BLOCK FLOW DIAGRAM
CAM/FAS SYSTEM

M003

Los Alamos

Los Alamos National Laboratory
Los Alamos, New Mexico 87545

PI:

DATE: 11-01-97 PL

HYDOX REACTOR
FURNACES

(G)

HEPA FILTER

GASLOCKS AT
VARIOUS LOCATIONS

(G)

HEPA FILTER

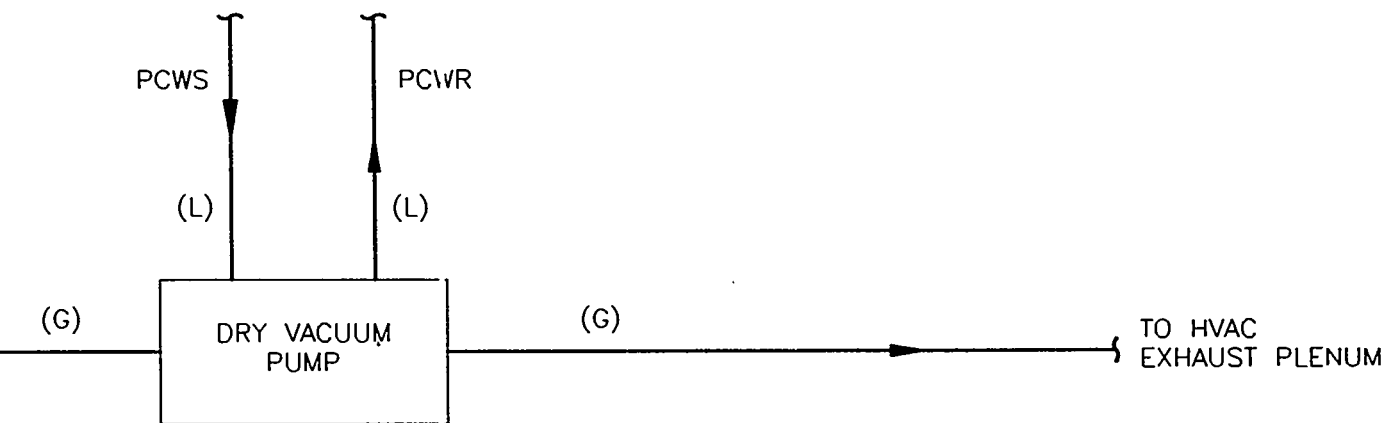
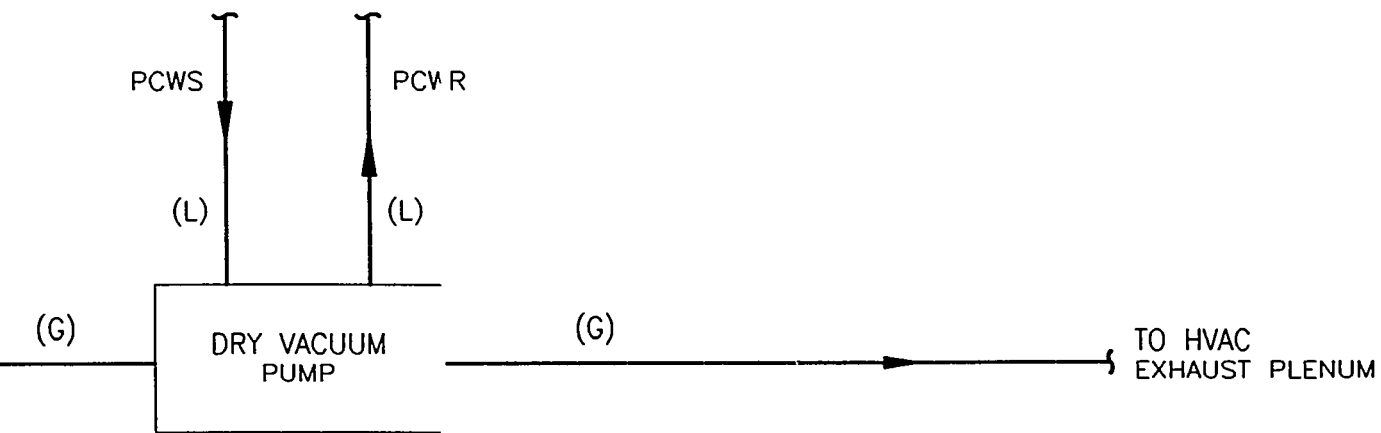

FLUOR DANIEL INC

PIT DISASSEMBLY &
CONVERSION FACILITY
CONCEPTUAL DESIGN

BLOCK FLOW DIAGRAM
HYDOX REACTOR/DRY VAC

M004

Los Alamos Los Alamos National Laboratory
Los Alamos, New Mexico 87545

PI: DATE: 11-01-97 PL

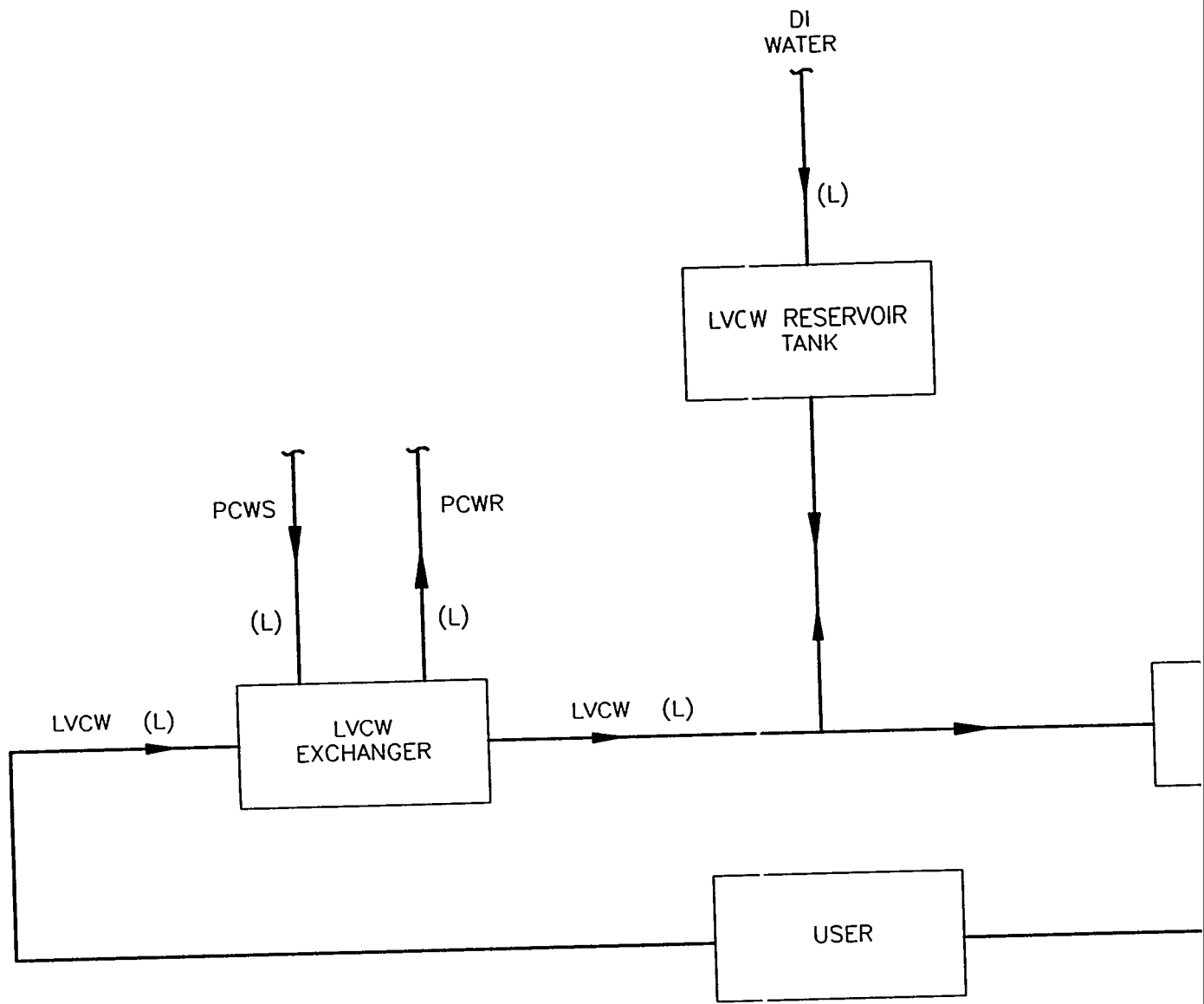

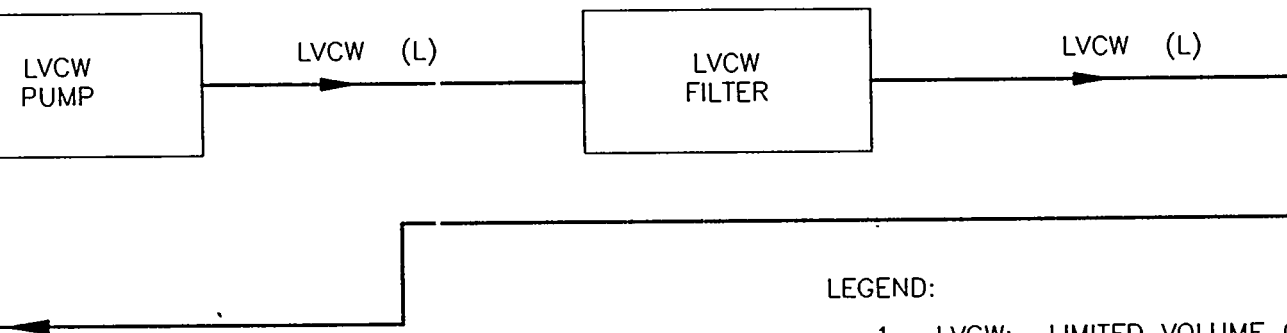

LEGEND:

- 1. LVCW: LIMITED VOLUME COOLING WATER
- 2. PCWS: PROCESS CHILLED WATER SUPPLY
- 3. PCWR: PROCESS CHILLED WATER RETURN
- 4. DI: DEIONIZED



FLUOR DANIEL INC

PIT DISASSEMBLY &
CONVERSION FACILITY
CONCEPTUAL DESIGN

BLOCK FLOW DIAGRAM
LV COOLING WATER

M005

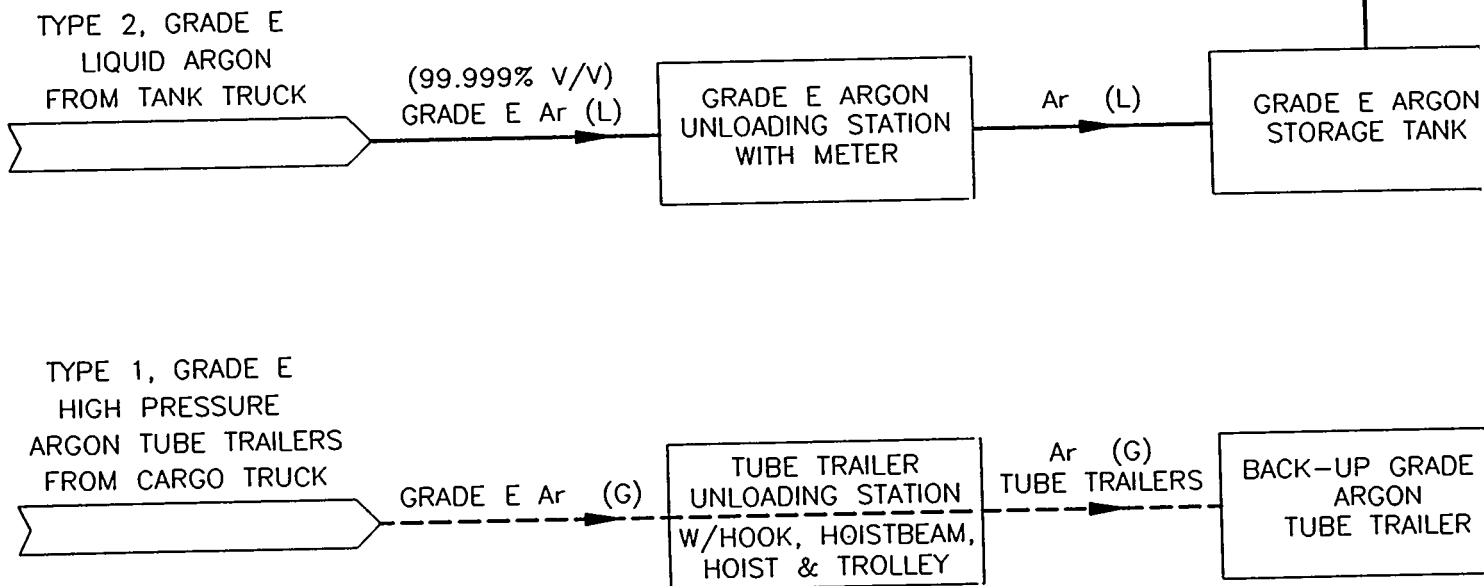

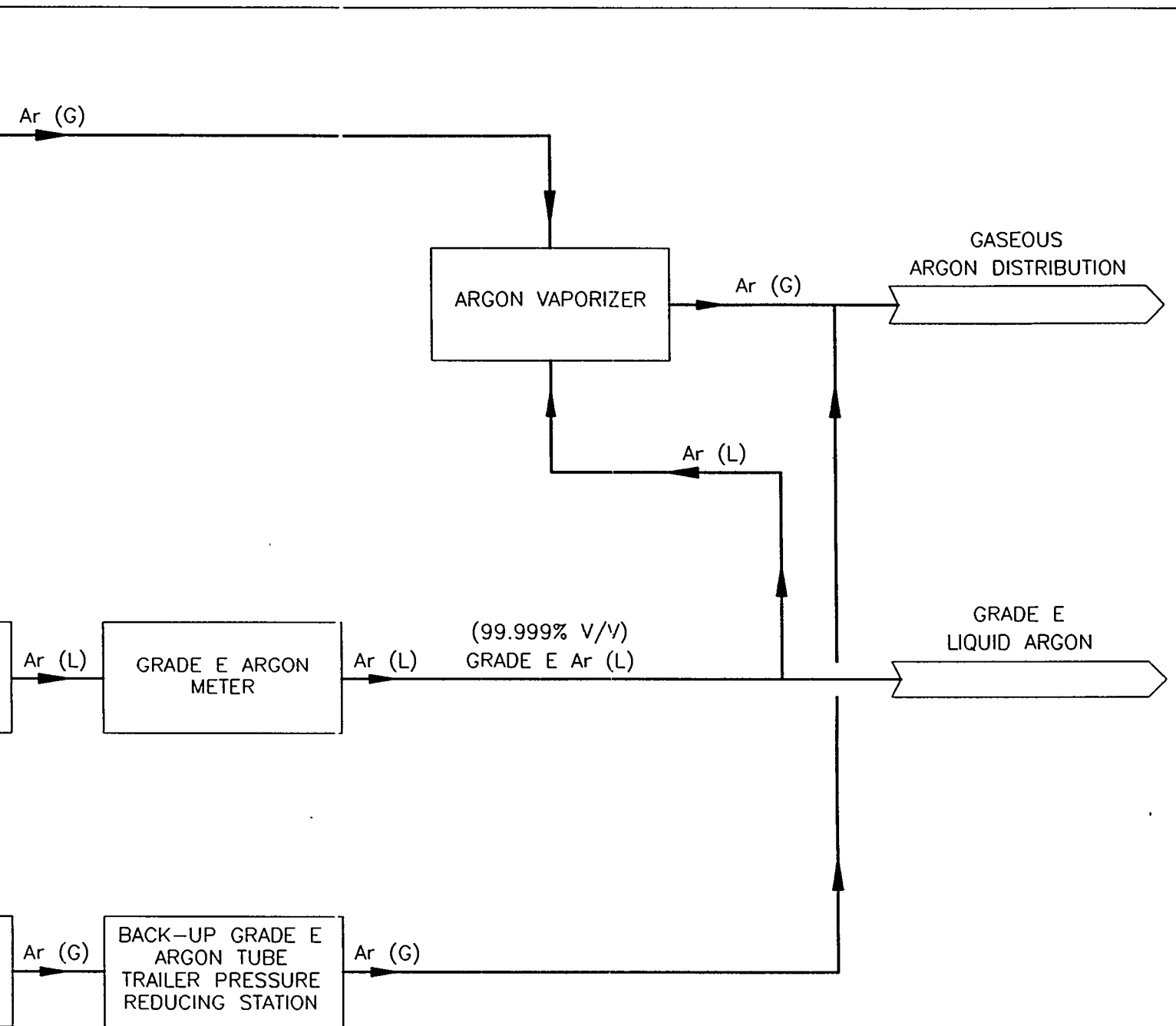

FLUOR DANIEL INC

PIT DISASSEMBLY &
CONVERSION FACILITY
CONCEPTUAL DESIGN

BLOCK FLOW DIAGRAM
LIQUEFIED ARGON SYSTEM

M006

Los Alamos Los Alamos National Laboratory
Los Alamos, New Mexico 87545

PI:

DATE: 11-01-97 PL

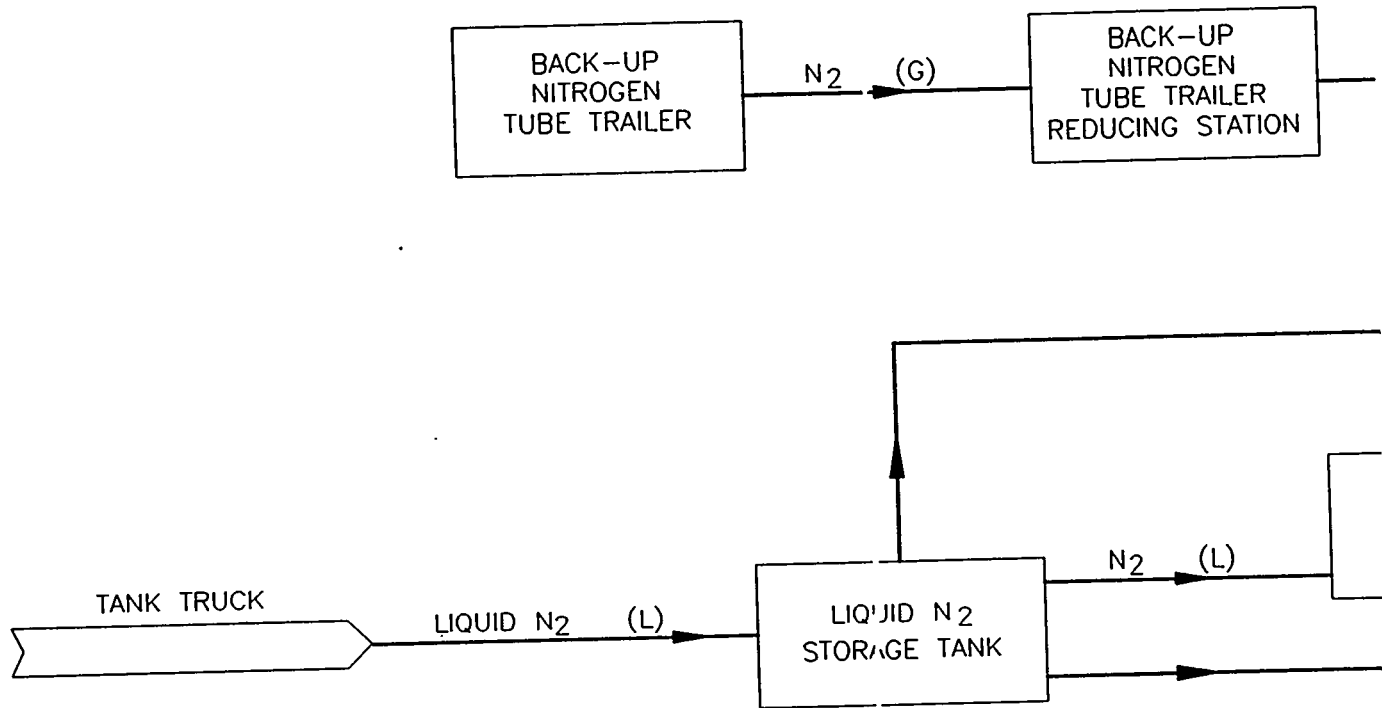

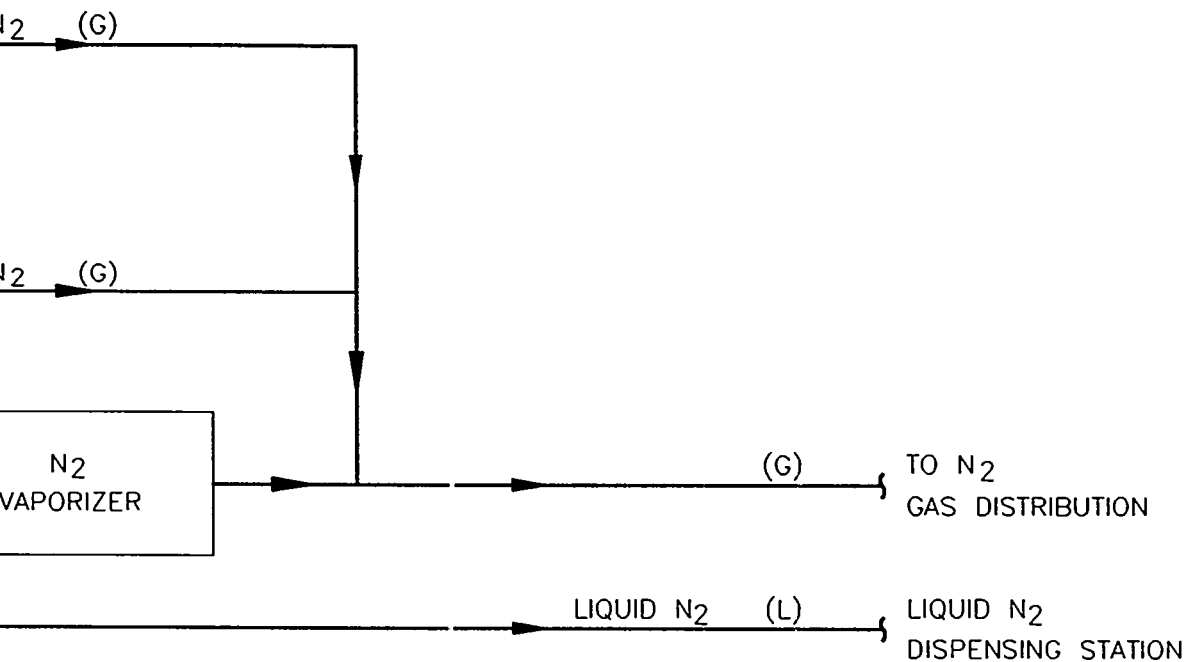

FLUOR DANIEL INC

PIT DISASSEMBLY &
 CONVERSION FACILITY
 CONCEPTUAL DESIGN

BLOCK FLOW DIAGRAM
 LIQUEFIED NITROGEN

M007



POLISHED DI WATER

ANALYTICAL
LABS

LEGEND

1. DI: DEIONIZED



FLUOR DANIEL INC

PIT DIASSEMBLY &
CONVERSION FACILITY
CONCEPTUAL DESIGN

BLOCK FLOW DIAGRAM
POLISHED DI WATER SYSTEM M008

Los Alamos Los Alamos National Laboratory
Los Alamos, New Mexico 87545

PI: DATE: 11-01-97 PL

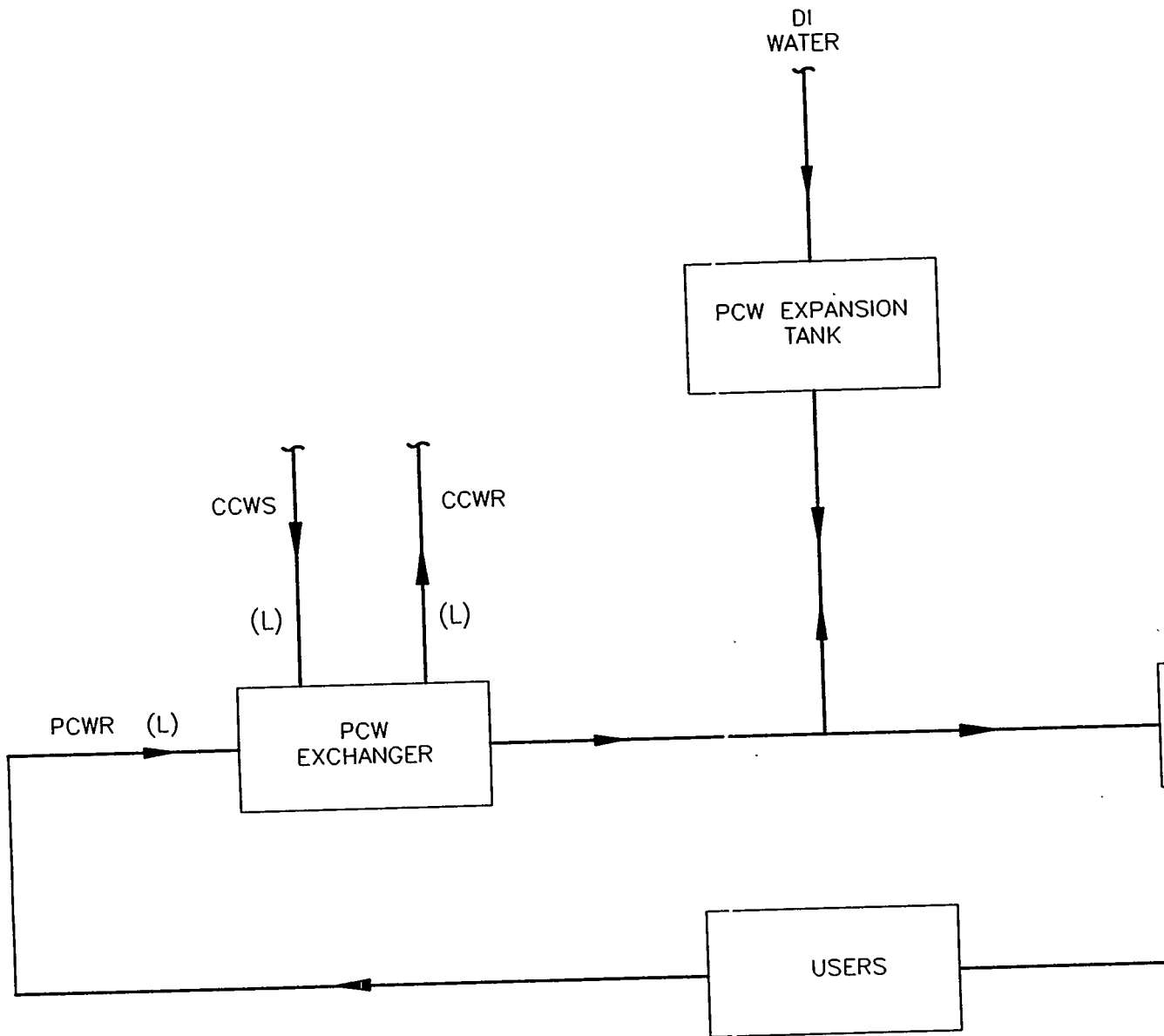

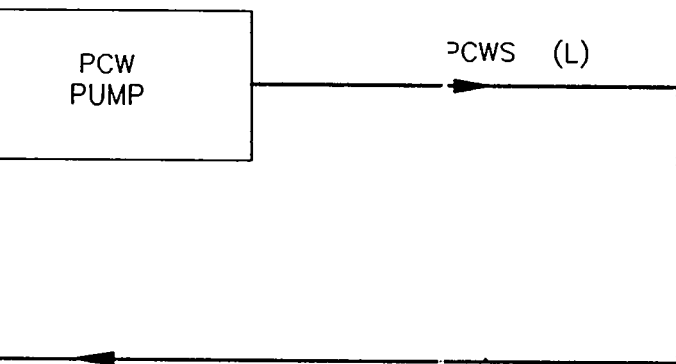

LEGEND:

1. PCW: PROCESS CHILLED WATER
2. PCWS: PROCESS CHILLED WATER SUPPLY
3. PCWR: PROCESS CHILLED WATER RETURN
4. CCWS: CENTRAL CHILLED WATER SUPPLY
5. CCWR: CENTRAL CHILLED WATER RETURN
6. DI: DEIONIZED



FLUOR DANIEL INC

PIT DISASSEMBLY &
 CONVERSION FACILITY
 CONCEPTUAL DESIGN

BLOCK FLOW DIAGRAM
 PROCESS CHILLED WATER

M009

Los Alamos Los Alamos National Laboratory
 Los Alamos, New Mexico 87545

PI: DATE: 11-01-97 PL

SPECIAL RECOVERY
LINE

(G)

TRITIUM RECOVERY
UNIT

(S)

(S)



← CHEMICALLY BOUND TRITIUM

← SOLID LLW

LEGEND

1. LLW: LOW LEVEL WASTE



FLUOR DANIEL INC

PIT DISASSEMBLY &
CONVERSION FACILITY
CONCEPTUAL DESIGN

BLOCK FLOW DIAGRAM
TRITIUM GATHERING/REMOVAL M010

Los Alamos Los Alamos National Laboratory
Los Alamos, New Mexico 87545

PI: DATE: 11-01-97 PL

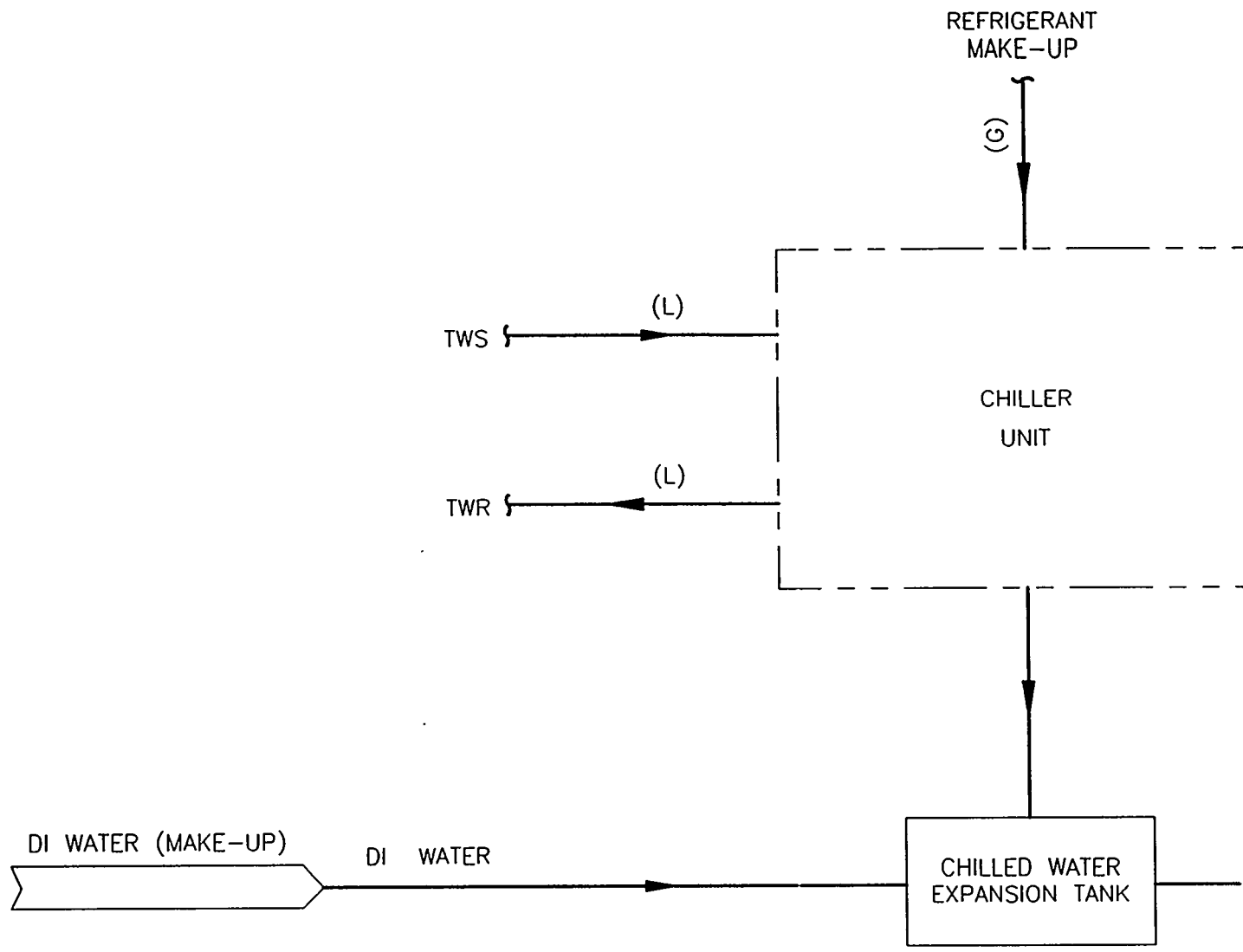

LEGEND

- 1. TWS: C
- 2. TWR: C
- 3. CCWS: C
- 4. CCWR: C
- 5. DI: C

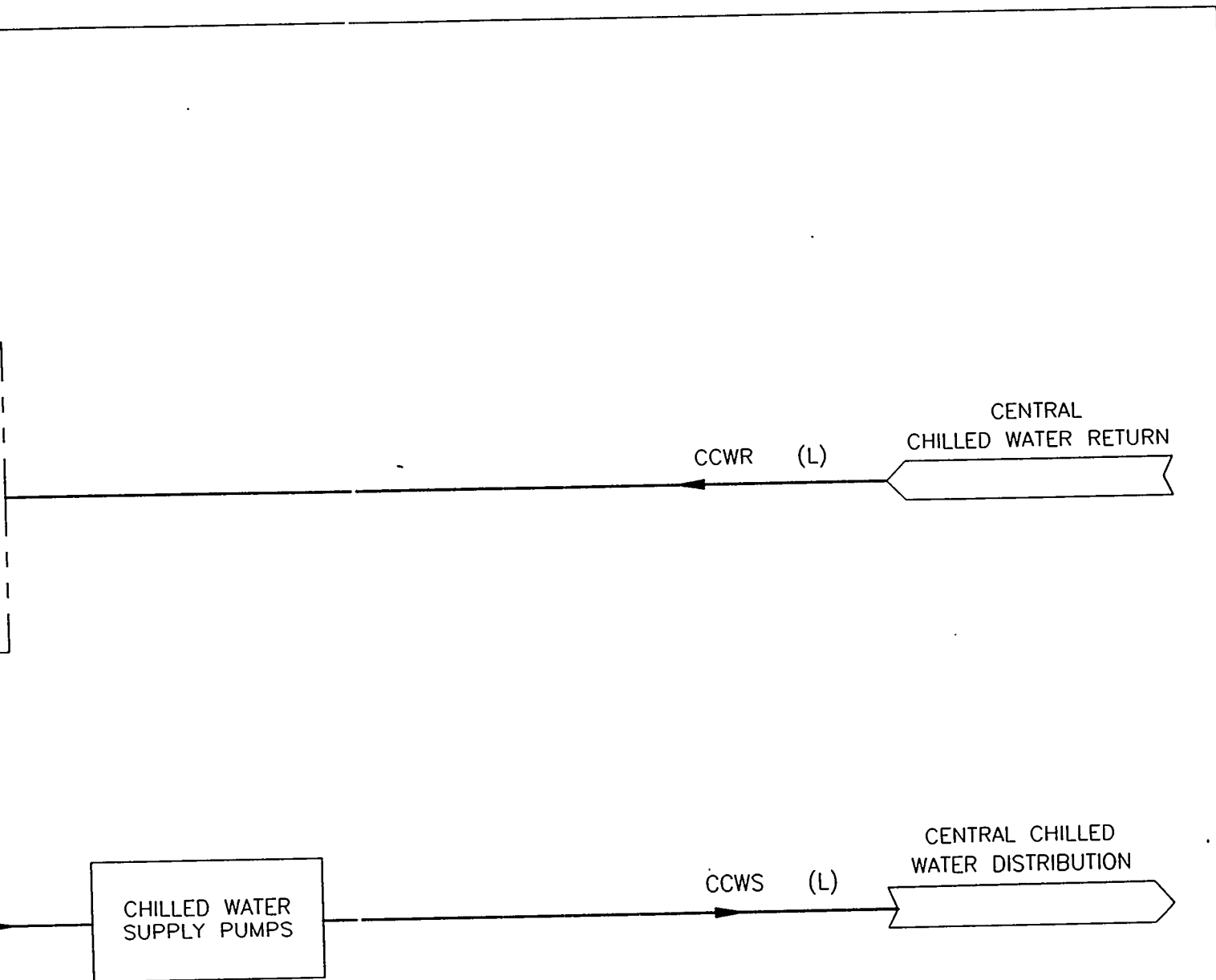

COOLING TOWER WATER SUPPLY
 COOLING TOWER WATER RETURN
 CENTRAL CHILLED WATER SUPPLY
 CENTRAL CHILLED WATER RETURN
 DEIONIZED



FLUOR DANIEL INC

PIT DISASSEMBLY &
 CONVERSION FACILITY
 CONCEPTUAL DESIGN

BLOCK FLOW DIAGRAM
 CHILLED WATER SYSTEM

M011

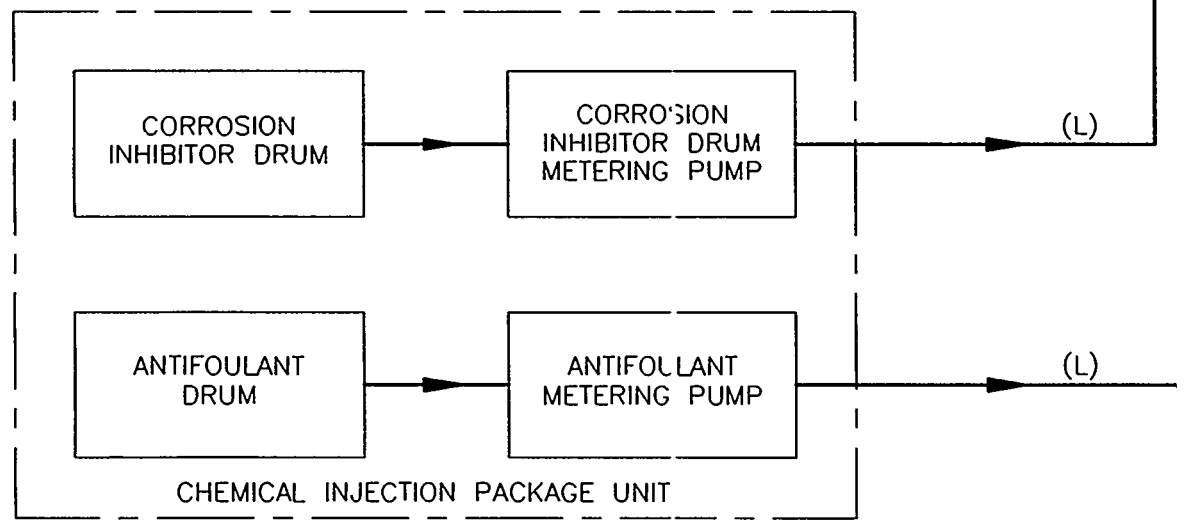
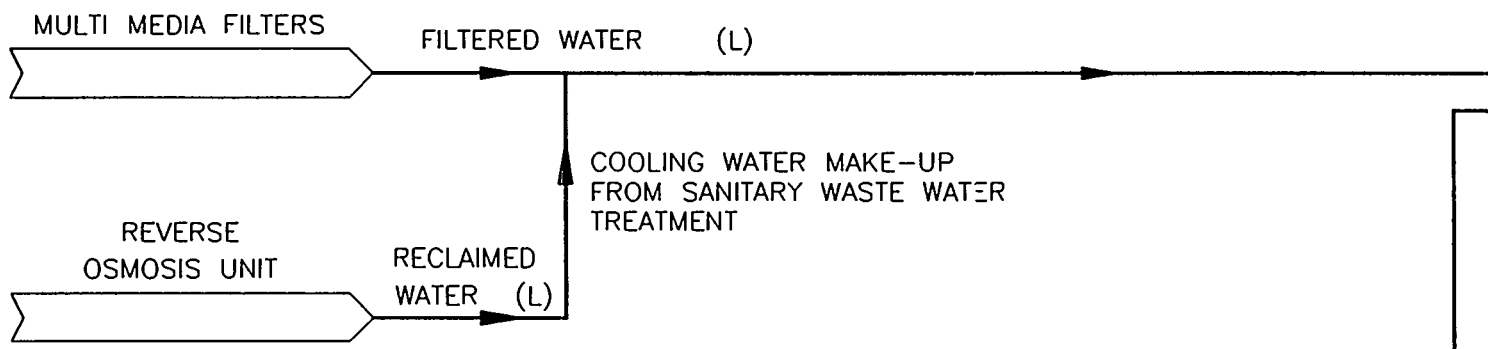
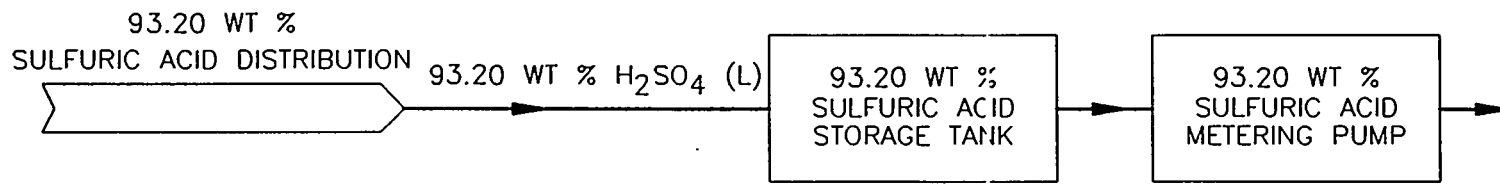

AM
NSATE

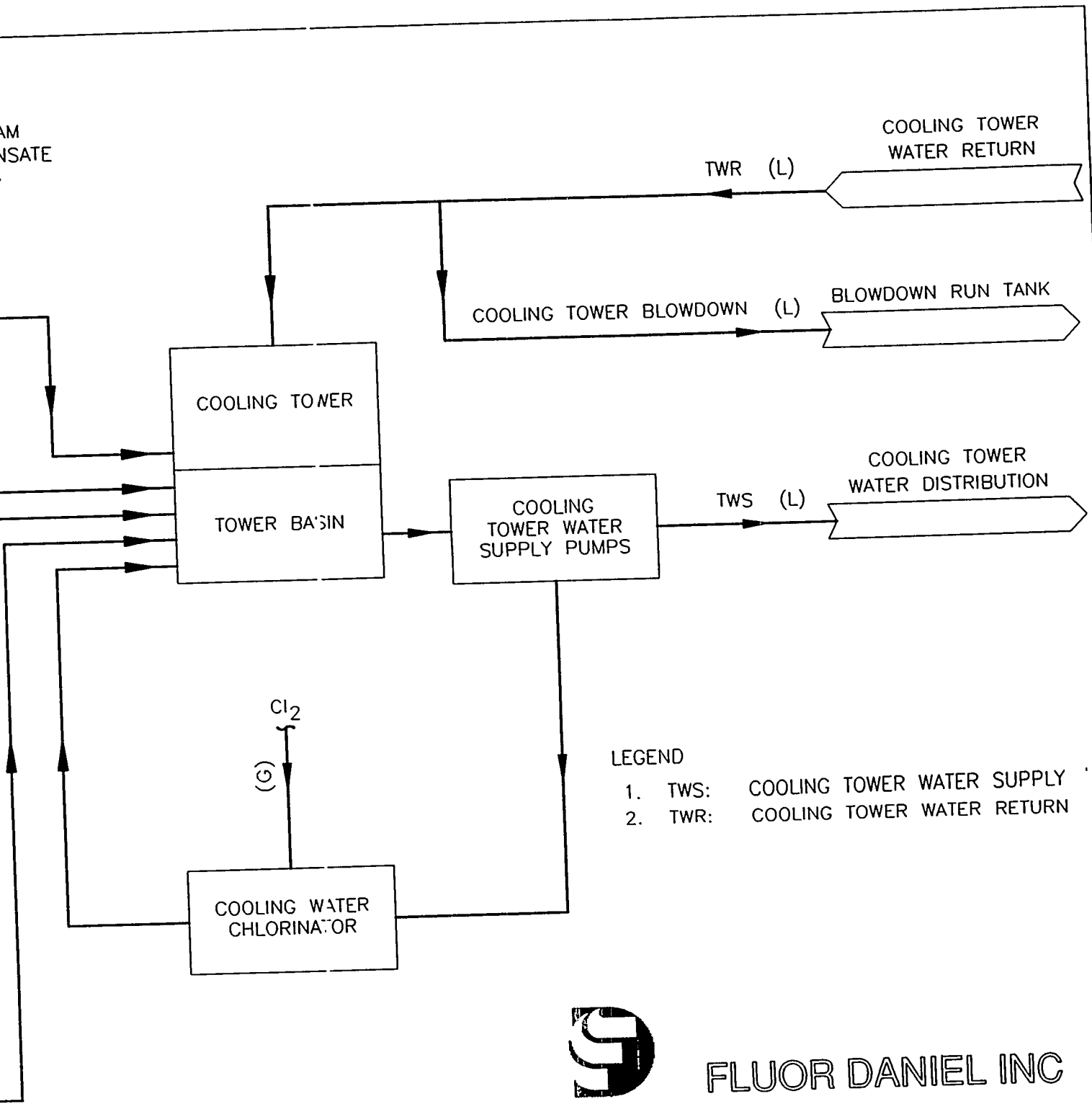

- LEGEND
- 1. TWS: COOLING TOWER WATER SUPPLY
 - 2. TWR: COOLING TOWER WATER RETURN



FLUOR DANIEL INC

PIT DISASSEMBLY &
CONVERSION FACILITY
CONCEPTUAL DESIGN

BLOCK FLOW DIAGRAM
COOLING TOWER WATER

M012

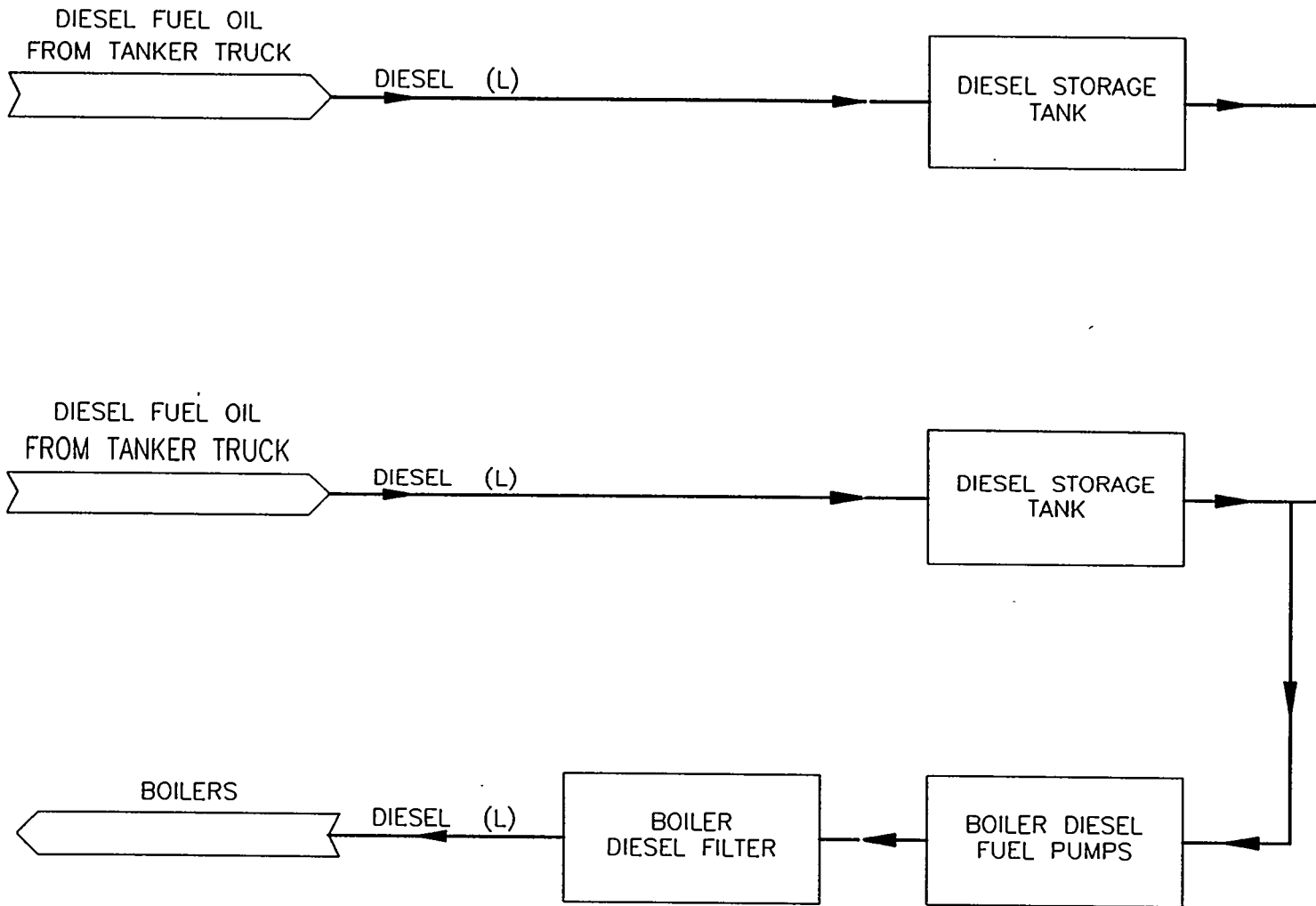

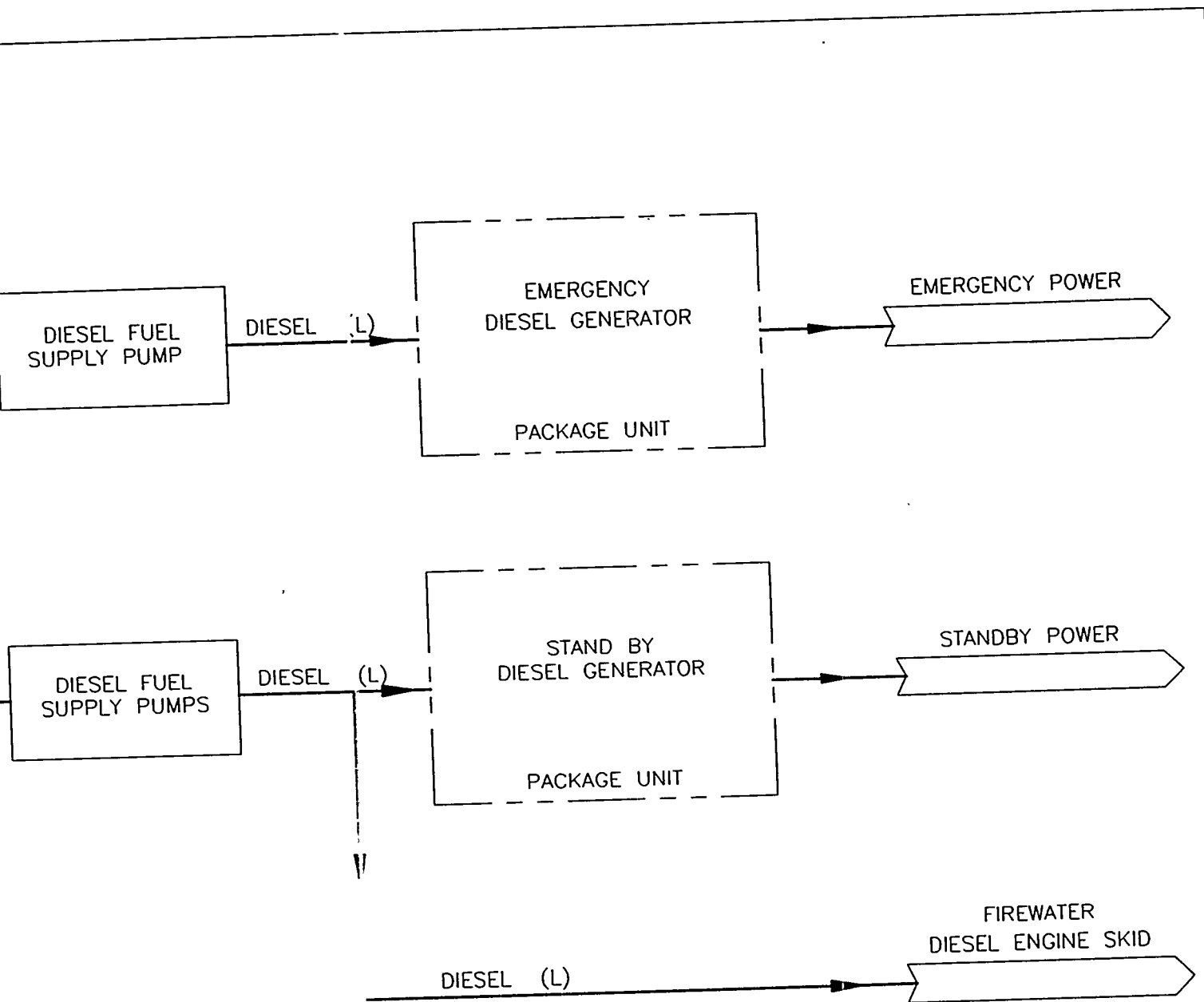

FLUOR DANIEL INC

PIT DISASSEMBLY &
CONVERSION FACILITY
CONCEPTUAL DESIGN

BLOCK FLOW DIAGRAM
EMERGENCY/STANDBY GEN

M013

Los Alamos

Los Alamos National Laboratory
Los Alamos, New Mexico 87545

PI:

DATE: 11-01-97 PL

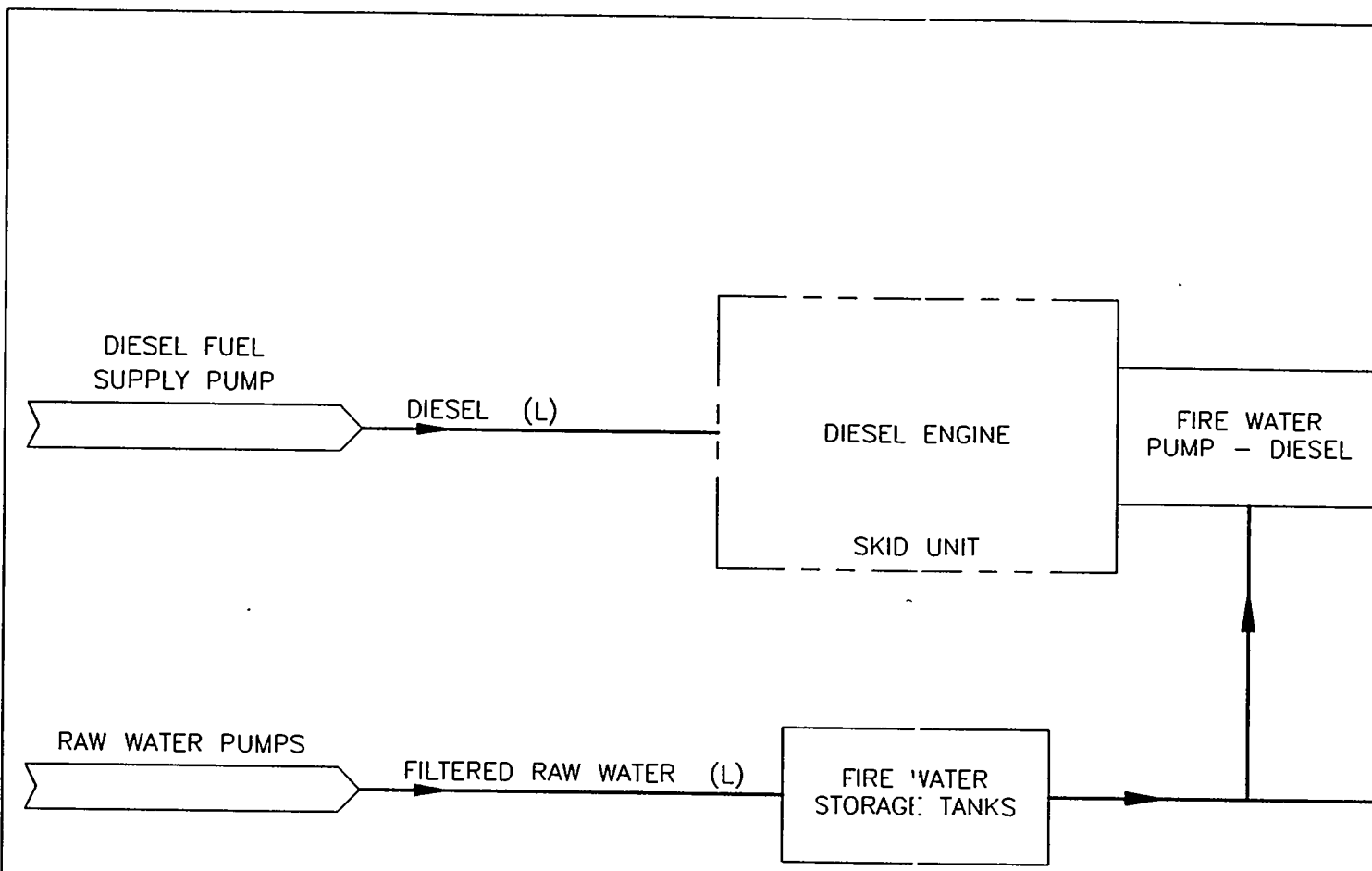

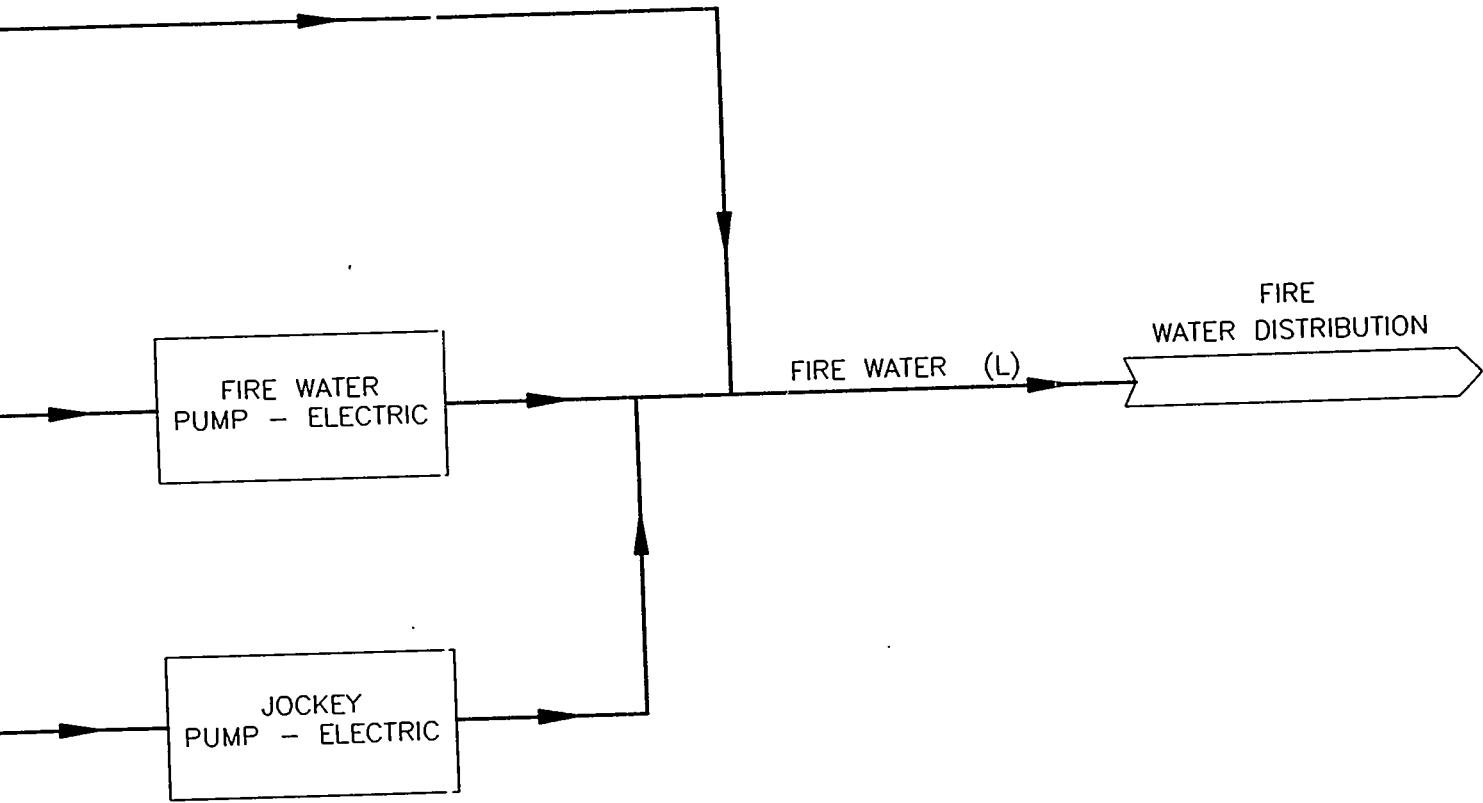

FLUOR DANIEL INC

PIT DISASSEMBLY &
 CONVERSION FACILITY
 CONCEPTUAL DESIGN

BLOCK FLOW DIAGRAM
 FIRE WATER SYSTEM

M014

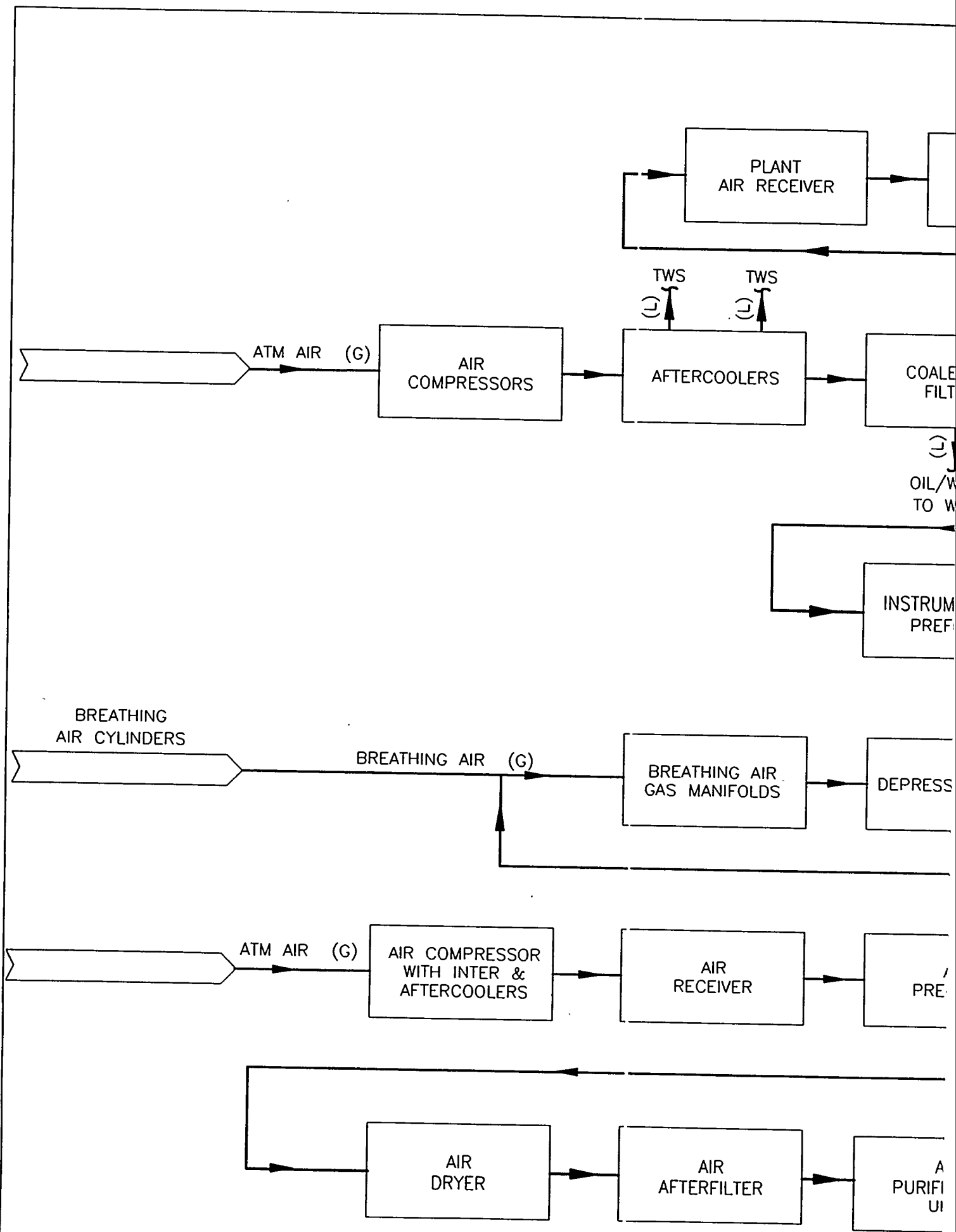

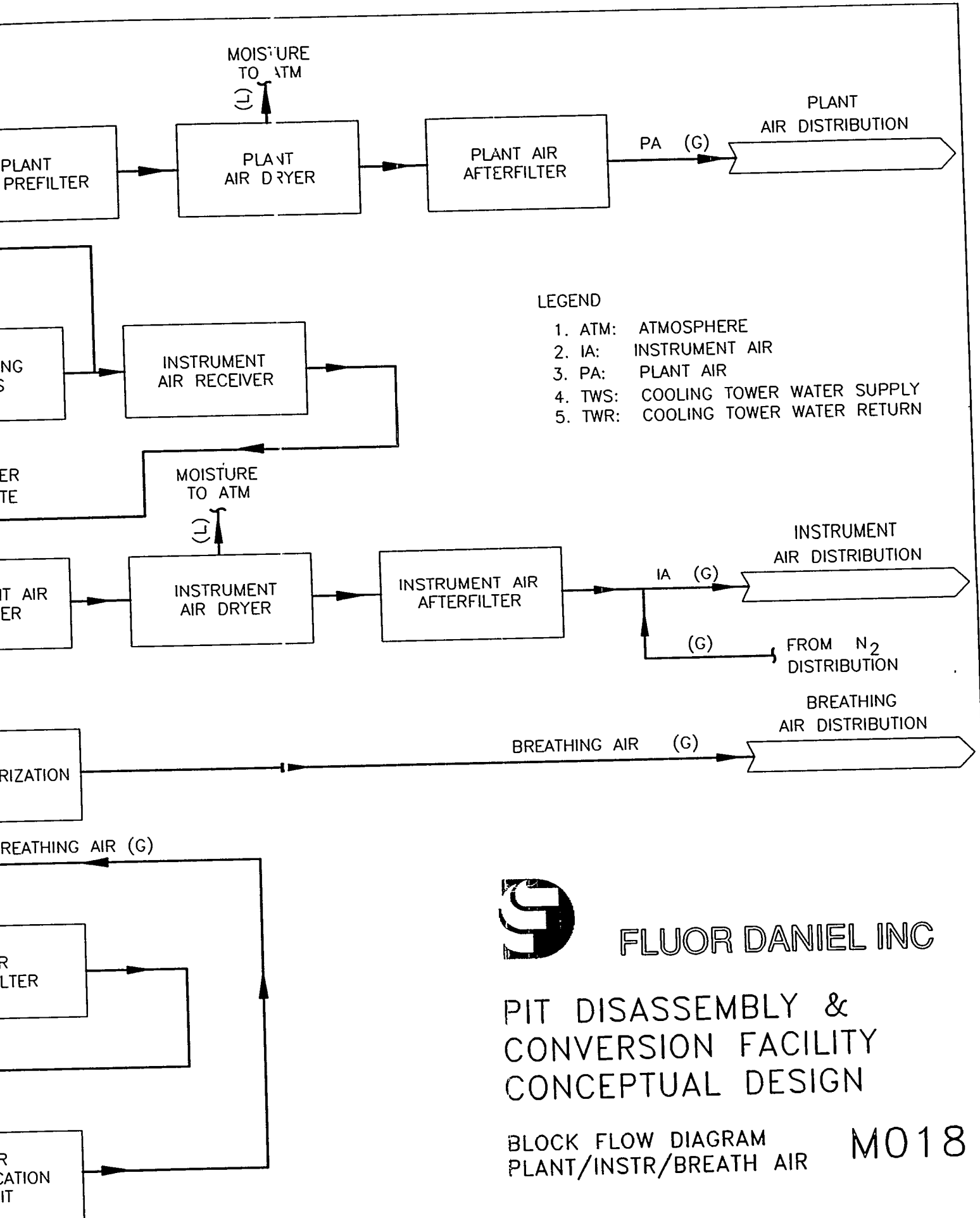

FLUOR DANIEL INC

PIT DISASSEMBLY &
CONVERSION FACILITY
CONCEPTUAL DESIGN

BLOCK FLOW DIAGRAM
PLANT/INSTR/BREATH AIR

M018

Los Alamos

Los Alamos National Laboratory
Los Alamos, New Mexico 87545

PI:

DATE: 11-01-97 PL

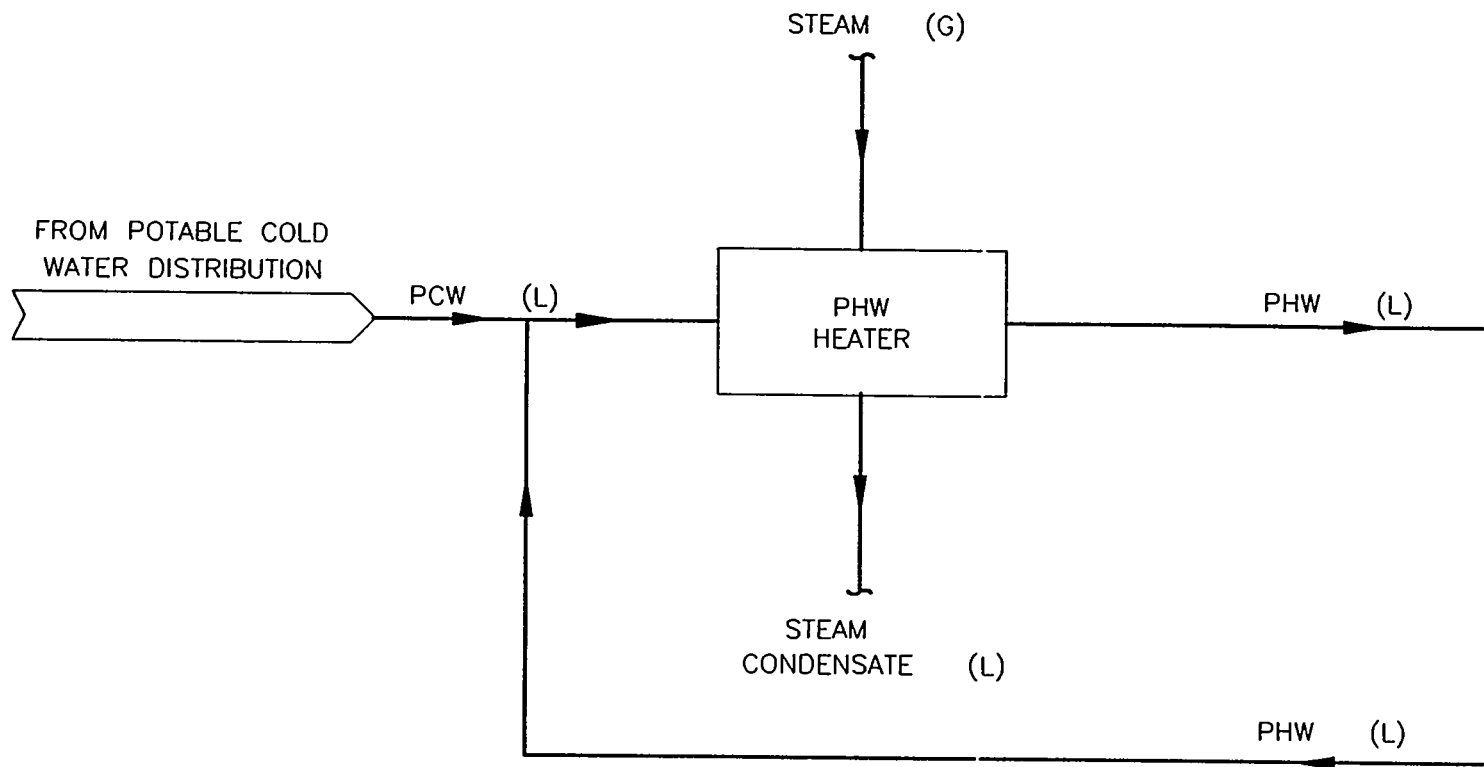

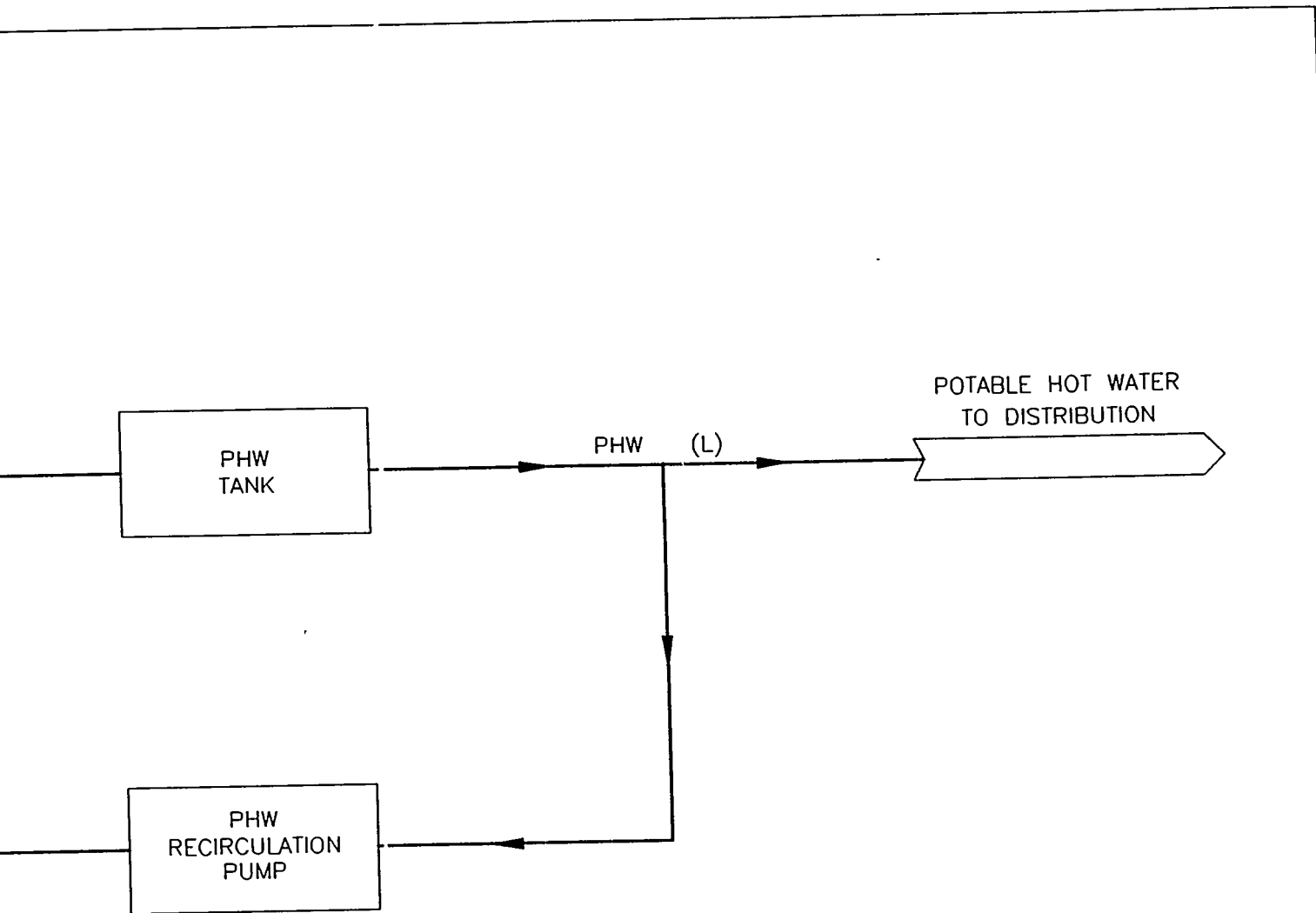

LEGEND

- 1. PCW: POTABLE COLD WATER
- 2. PHW: POTABLE HOT WATER



FLUOR DANIEL INC

PIT DISASSEMBLY &
 CONVERSION FACILITY
 CONCEPTUAL DESIGN

BLOCK FLOW DIAGRAM
 POTABLE HOT WATER

M019

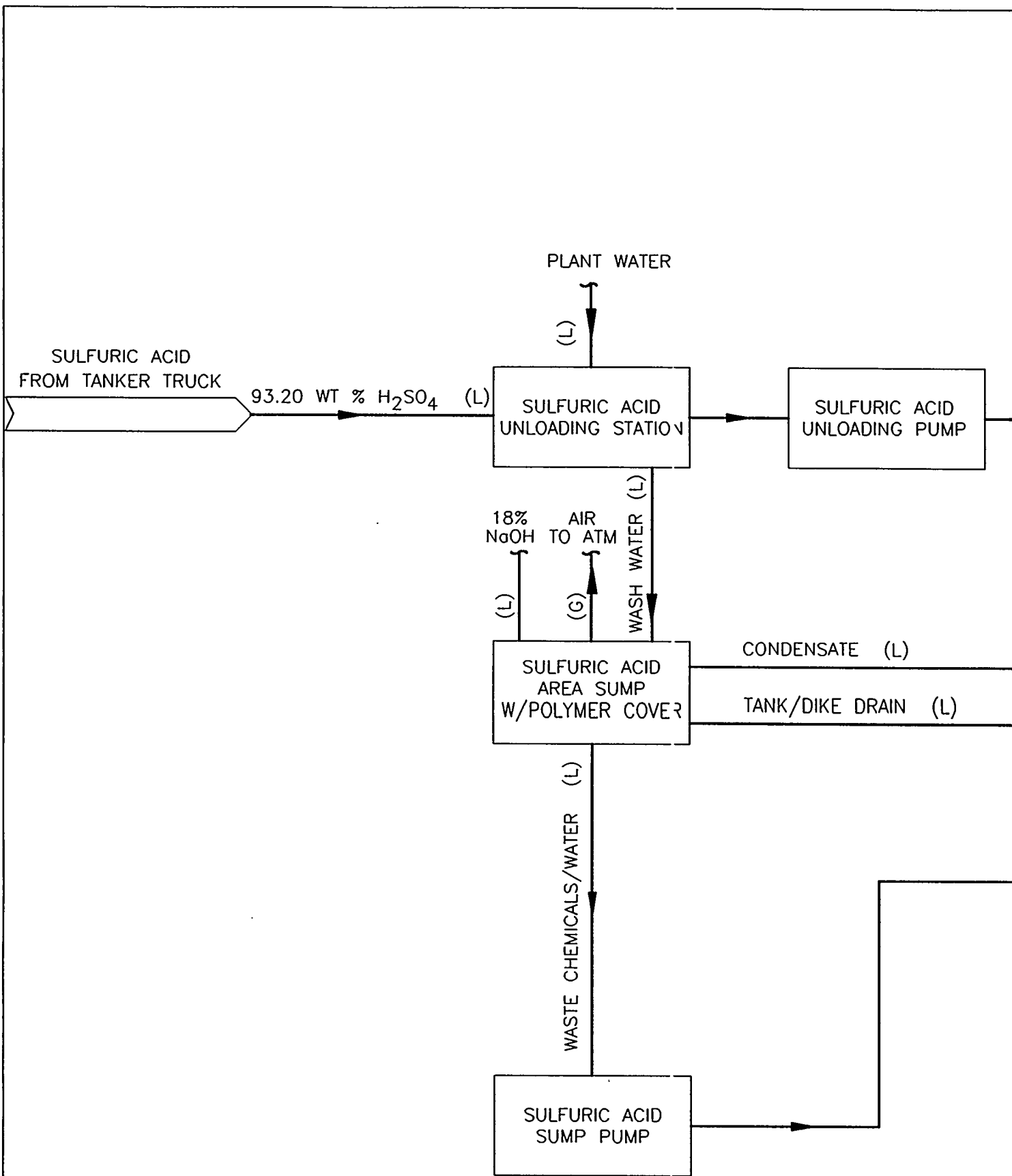

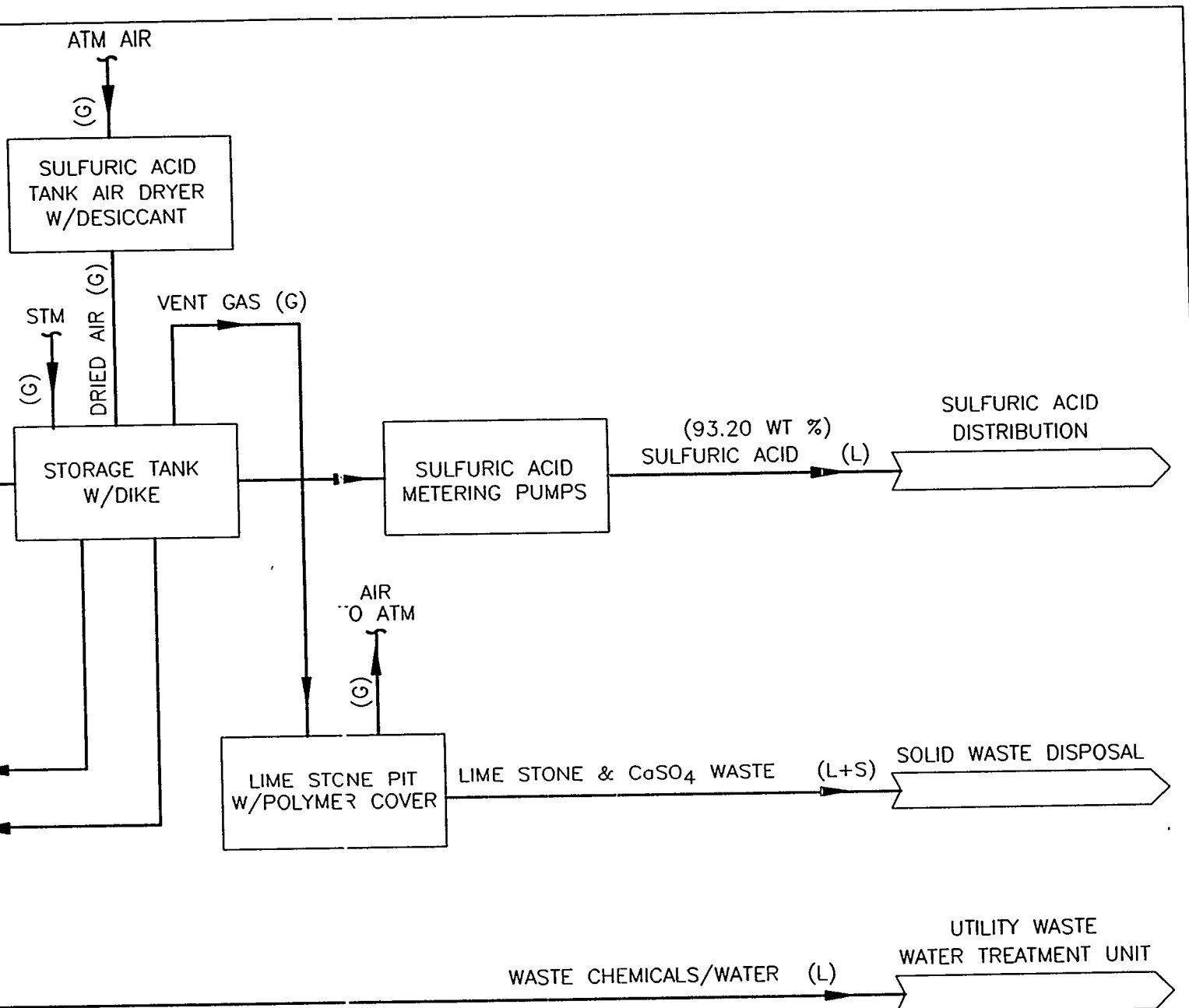

FLUOR DANIEL INC

PIT DISASSEMBLY &
CONVERSION FACILITY
CONCEPTUAL DESIGN

BLOCK FLOW DIAGRAM
SULFURIC ACID REC & STOR

M022

Los Alamos

Los Alamos National Laboratory
Los Alamos, New Mexico 87545

PI:

DATE: 11-01-97 PL

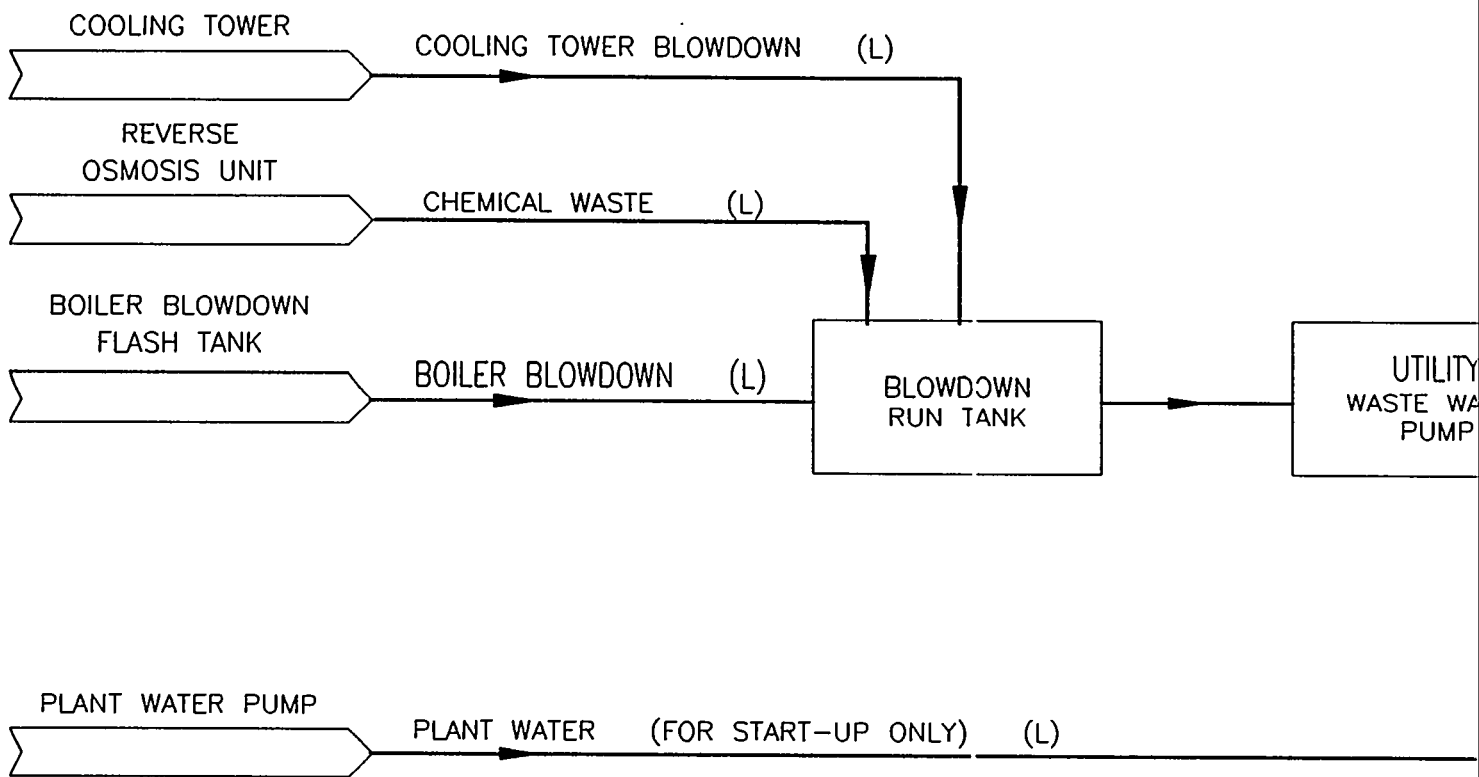

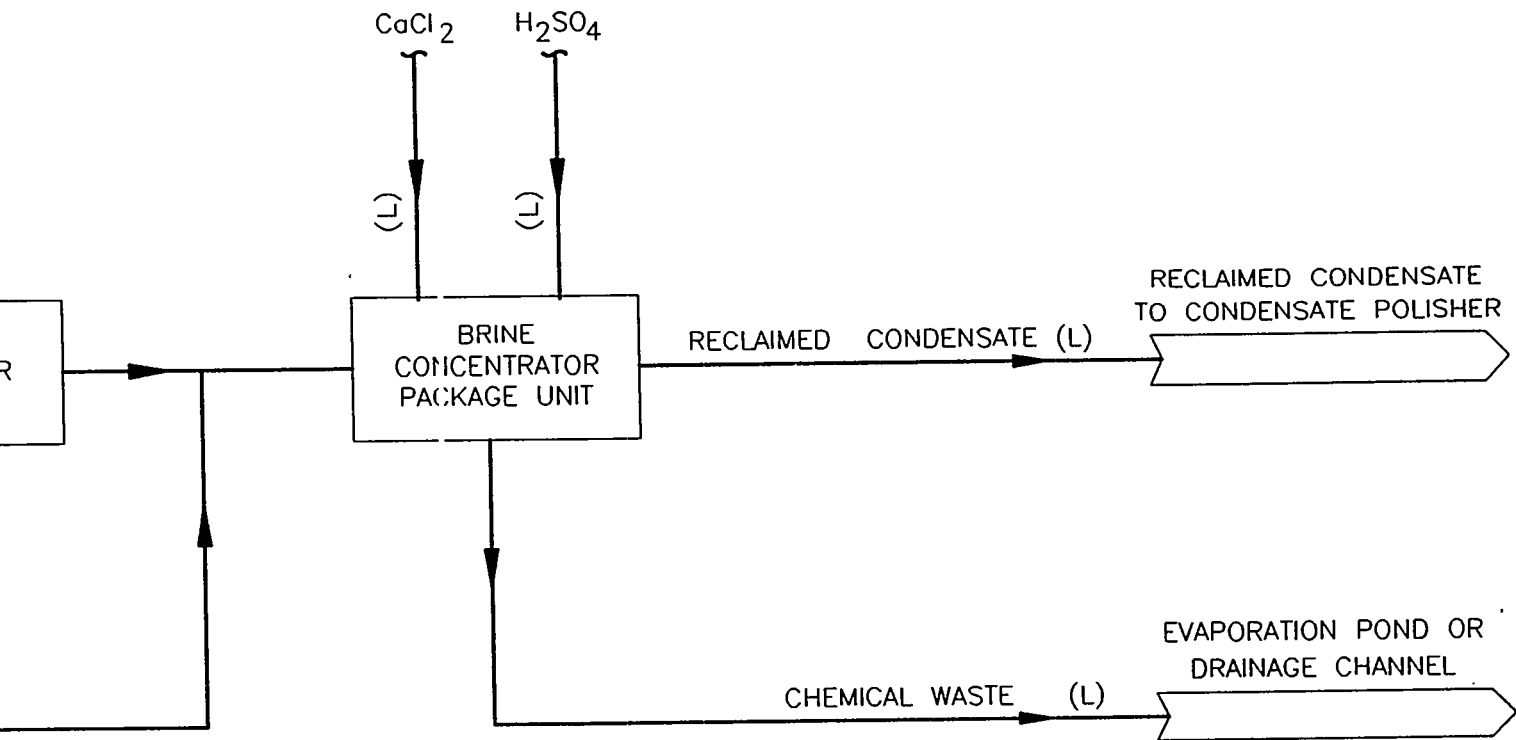

FLUOR DANIEL INC

LEGEND

- 1. CaCl_2 = CALCIUM CHLORIDE
- 2. H_2SO_4 = SULFURIC ACID

PIT DISASSEMBLY &
 CONVERSION FACILITY
 CONCEPTUAL DESIGN

BLOCK FLOW DIAGRAM
 UTILITY WASTE WATER

M023

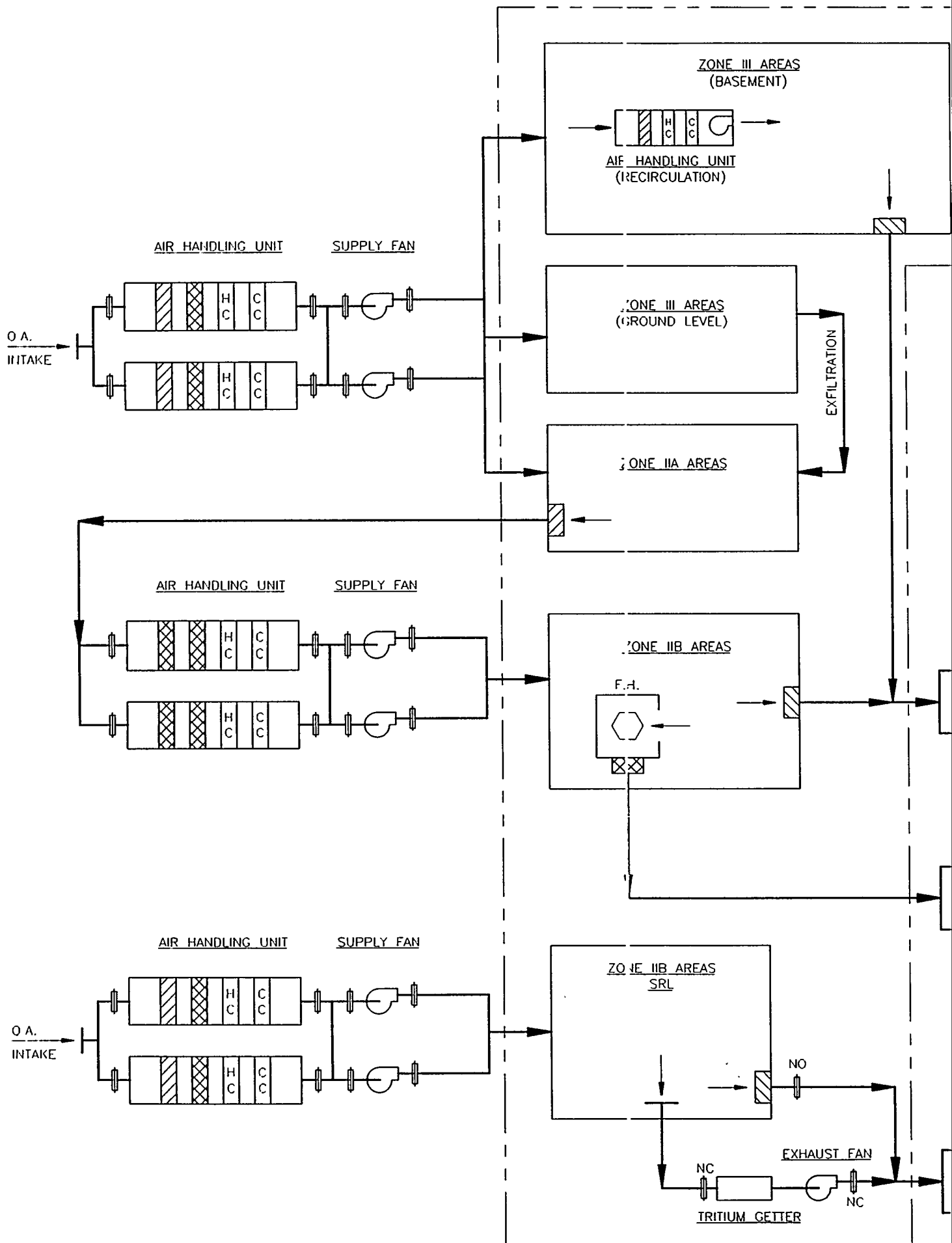

MATERIAL ACCESS AREAS

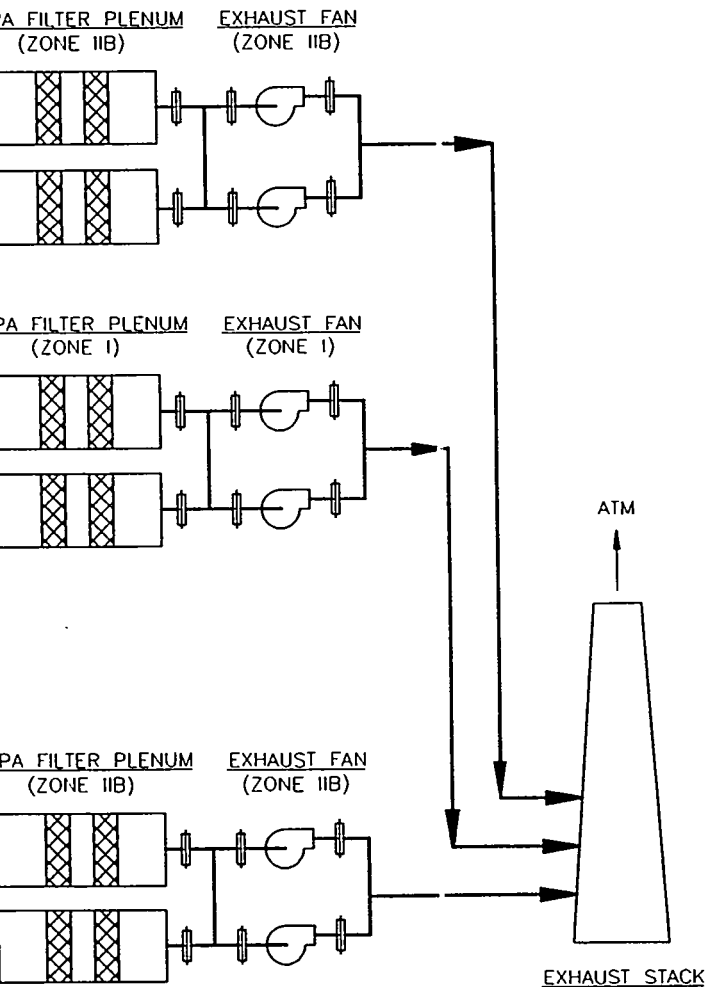

FLUOR DANIEL INC

PIT DISSASSEMBLY &
CONVERSION FACILITY
CONCEPTUAL DESIGN

HVAC FLOW DIAGRAM
MATERIAL ACCESS AREAS

M101

Los Alamos

Los Alamos National Laboratory
Los Alamos, New Mexico 87545

PI:

DATE: 11-01-97 PL

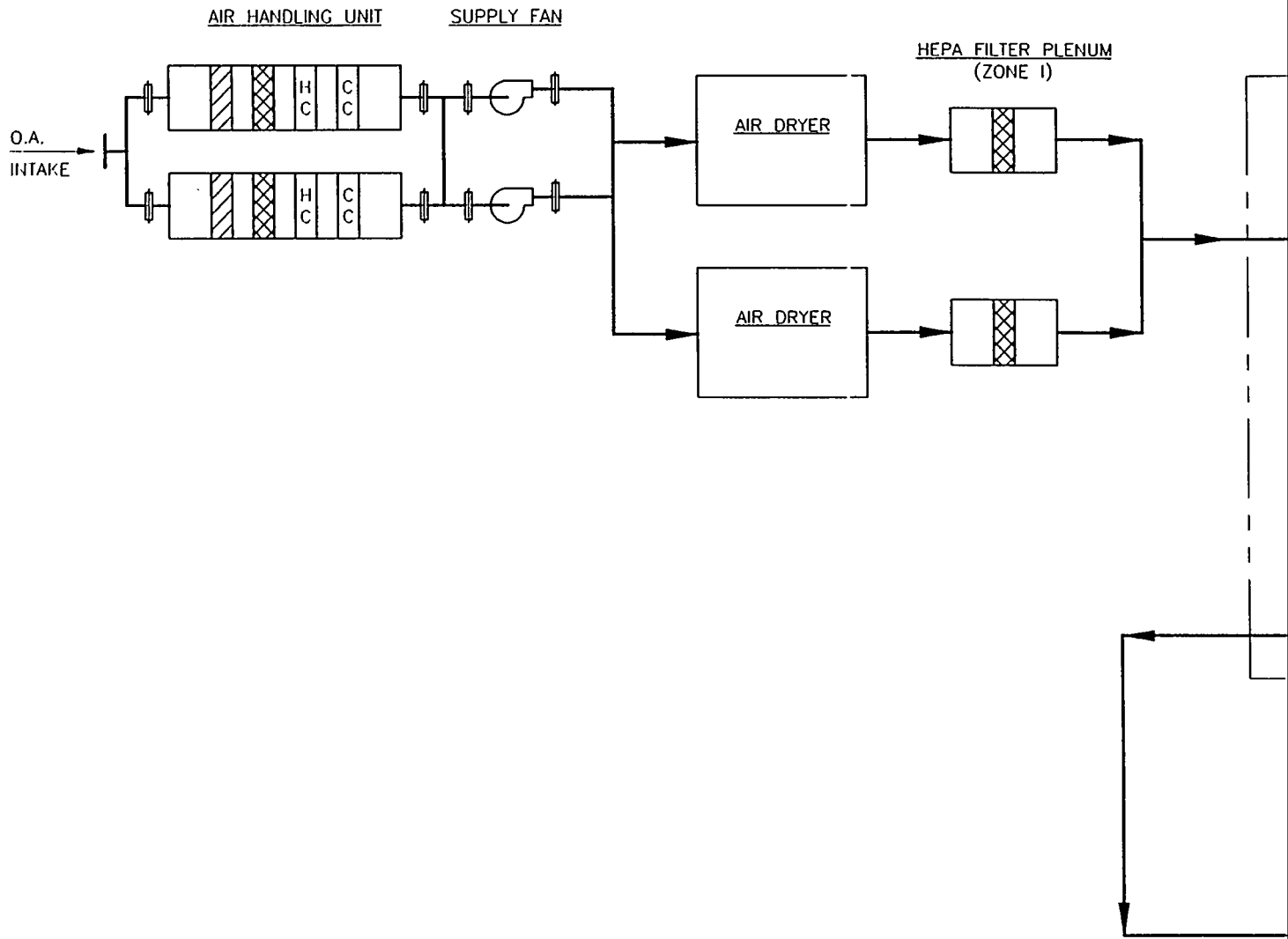

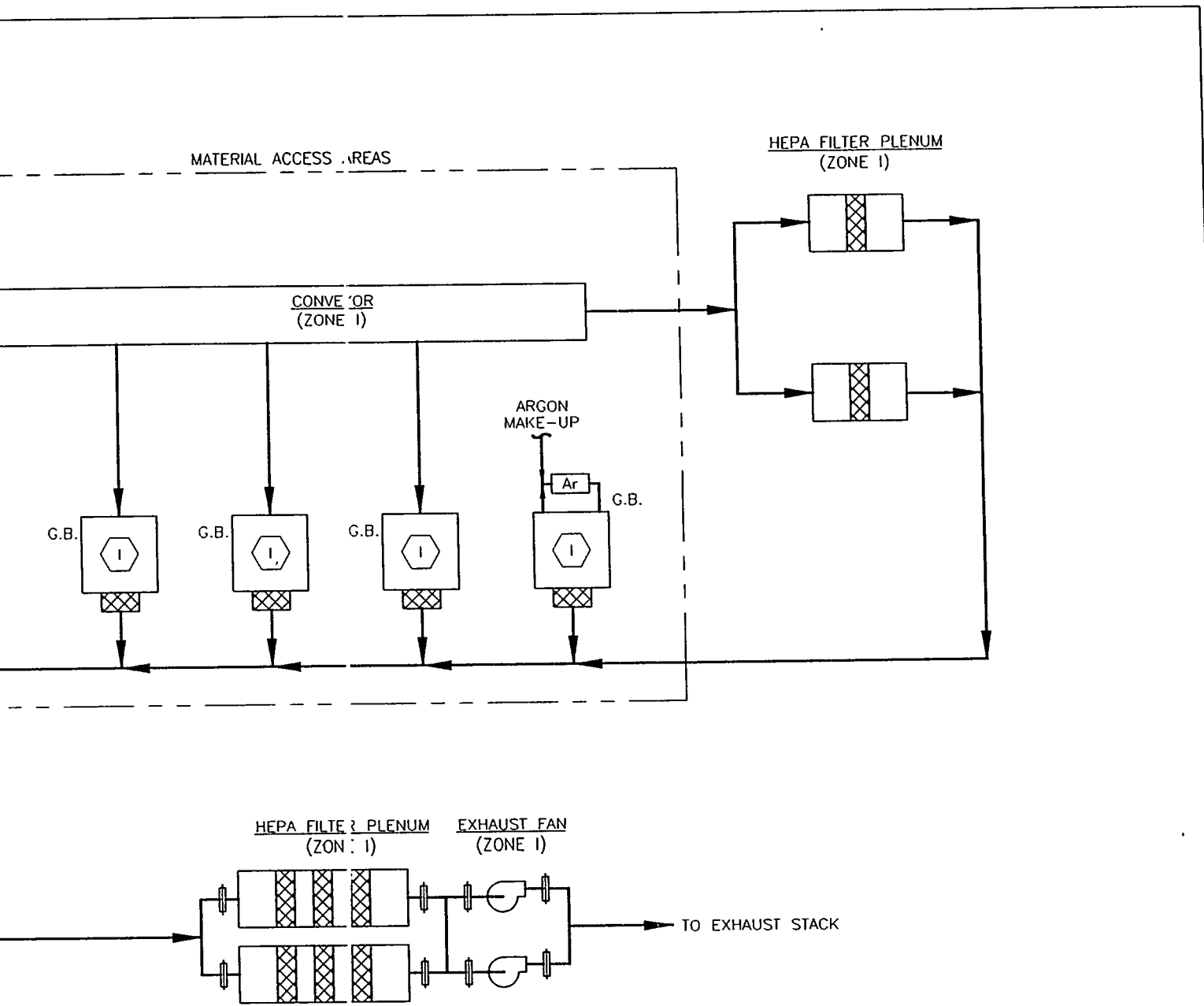

FLUOR DANIEL INC

PIT DISASSEMBLY &
 CONVERSION FACILITY
 CONCEPTURAL DESIGN

HVAC FLOW DIAGRAM
 MATERIAL ACCESS AREAS

M102

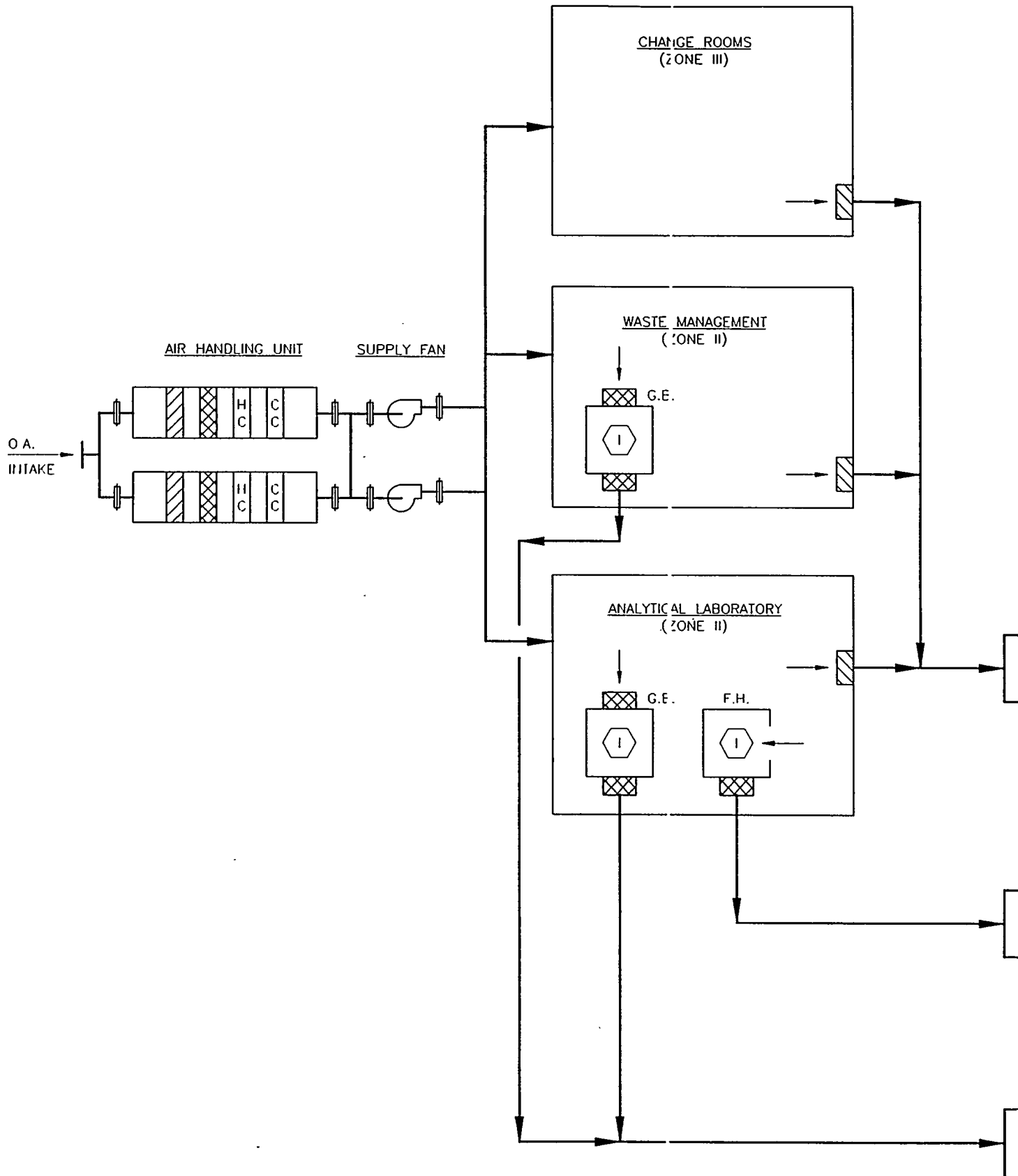

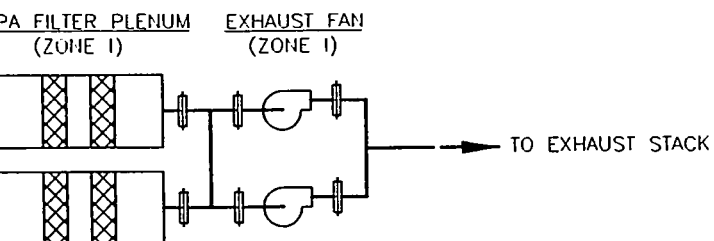
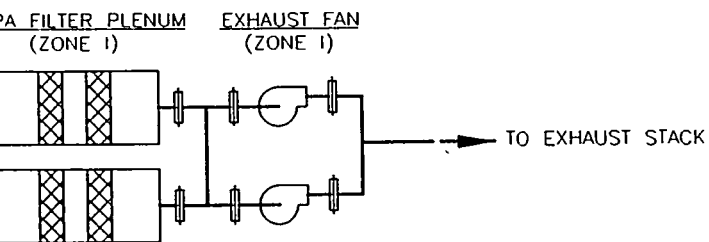
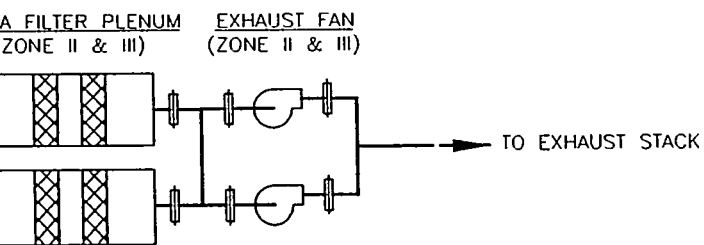

FLUOR DANIEL INC

PIT DISASSEMBLY &
CONVERSION FACILITY
CONCEPTUAL DESIGN

HAVC FLOW DIAGRAM
WASTE MANAGEMENT AREAS M103

AIR HANDLING UNIT
(TYP)

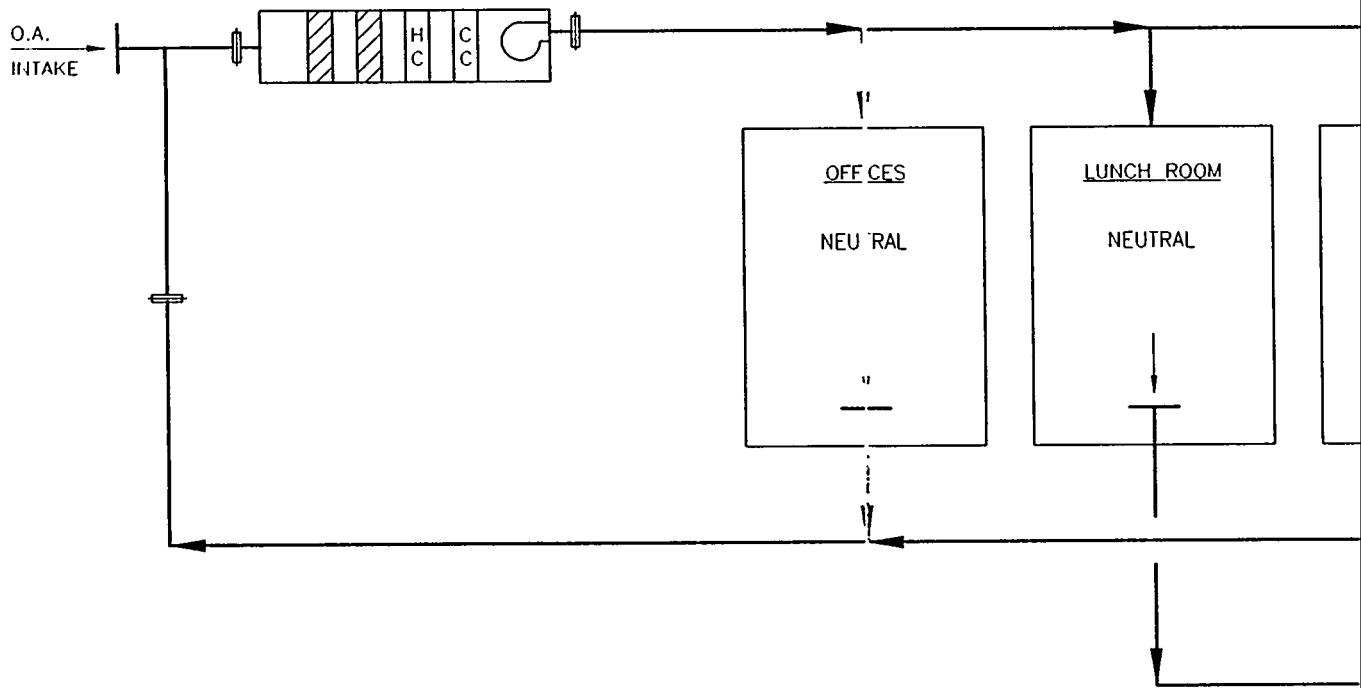
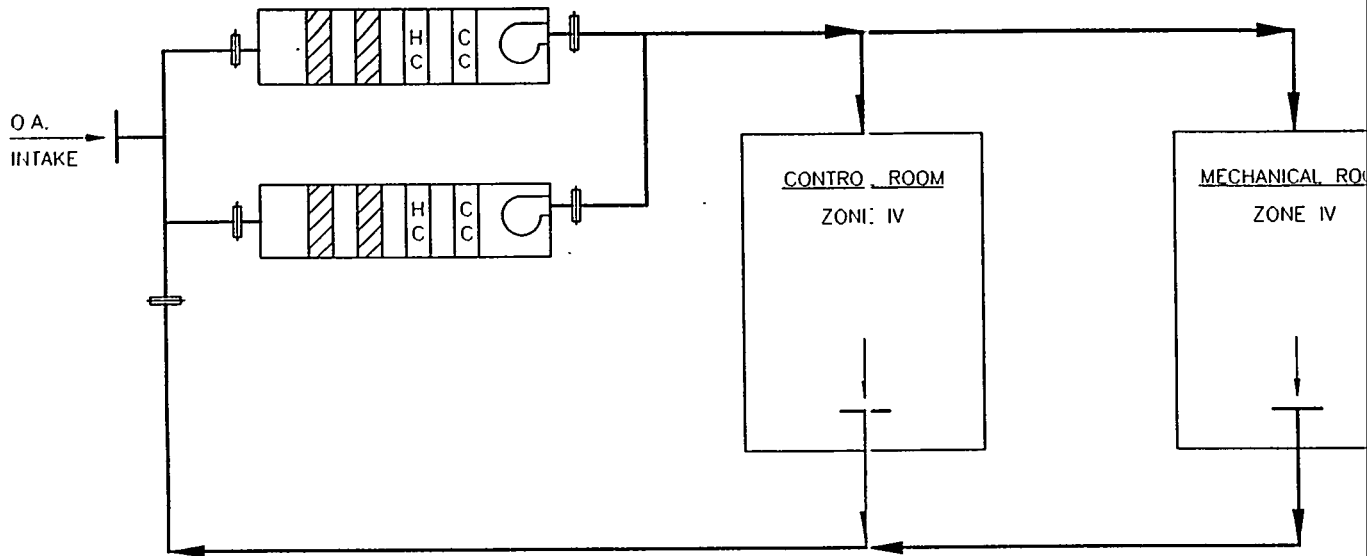

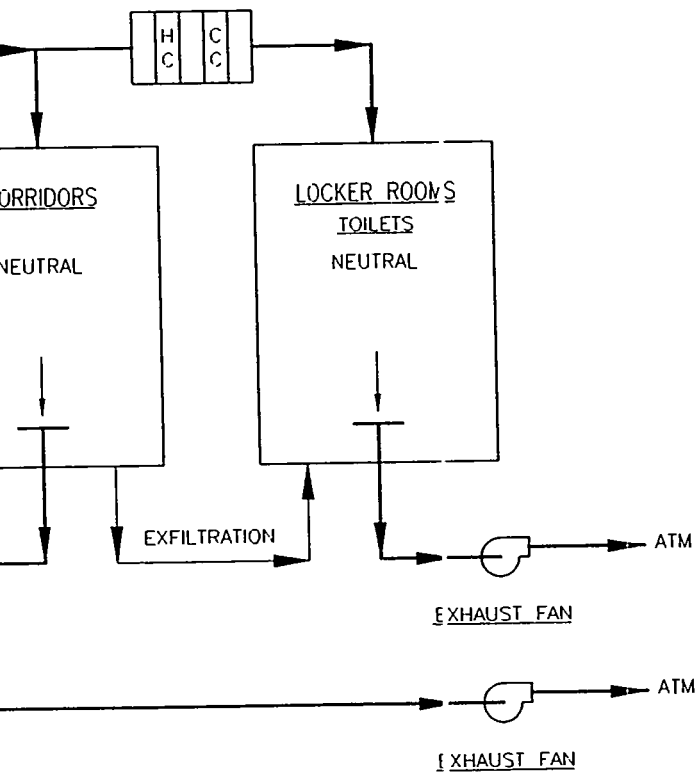

FLUOR DANIEL INC

PIT DISASSEMBLY &
 CONVERSION FACILITY
 CONCEPTUAL DESIGN

HVAC FLOW DIAGRAM
 MISCELLANEOUS AREAS

M104

Los Alamos National Laboratory
 Los Alamos, New Mexico 87545



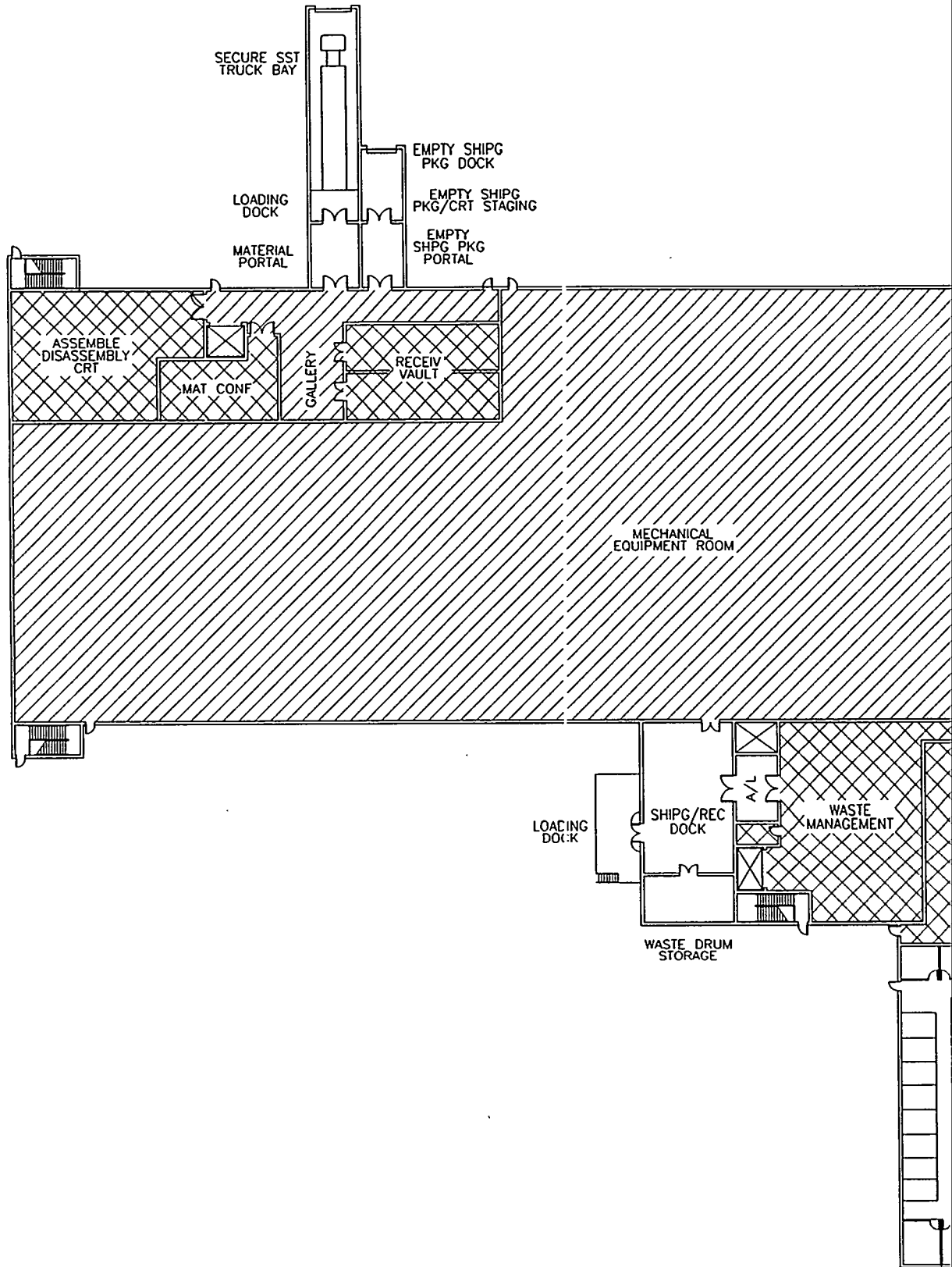

PI:

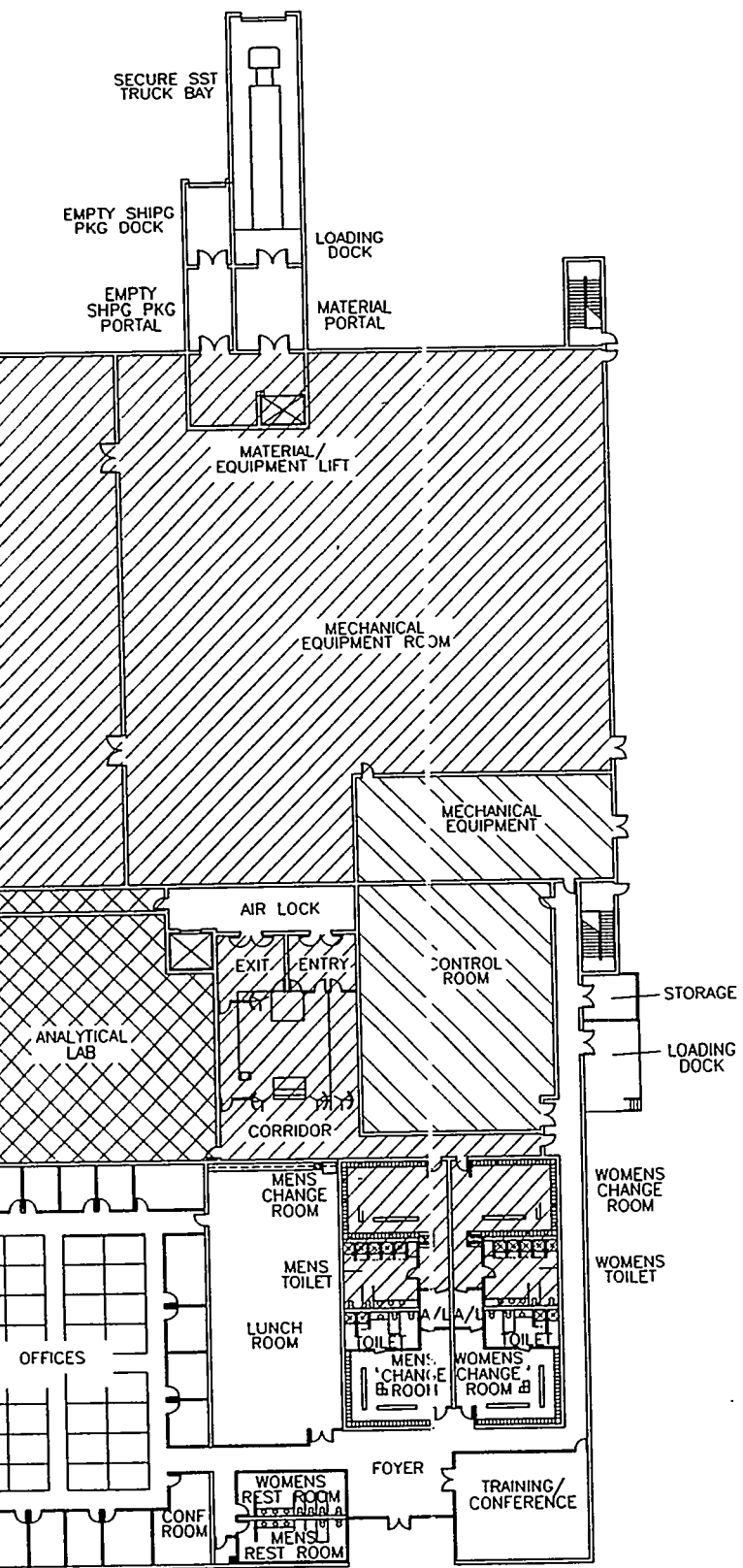
DATE: 11-01-97 PL



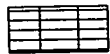

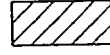
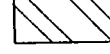
CONFINEMENT LEGEND

-  ZONE IIB
-  ZONE IIA
-  ZONE III
-  ZONE IV
-  NEUTRAL ZONE

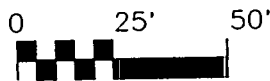

FLUOR DANIEL INC

PIT DISASSEMBLY &
CONVERSION FACILITY
CONCEPTUAL DESIGN

HVAC CONFINEMENT ZONES M105
FIRST FLOOR LEVEL

REFERENCE BUILDING

Los Alamos Los Alamos National Laboratory
Los Alamos, New Mexico 87545

PI: DATE: 11-01-97 PL

OUTLINE OF
FIRST FLOOR
(ABOVE)

PRODUCT VAULT

PRODUCT VAULT

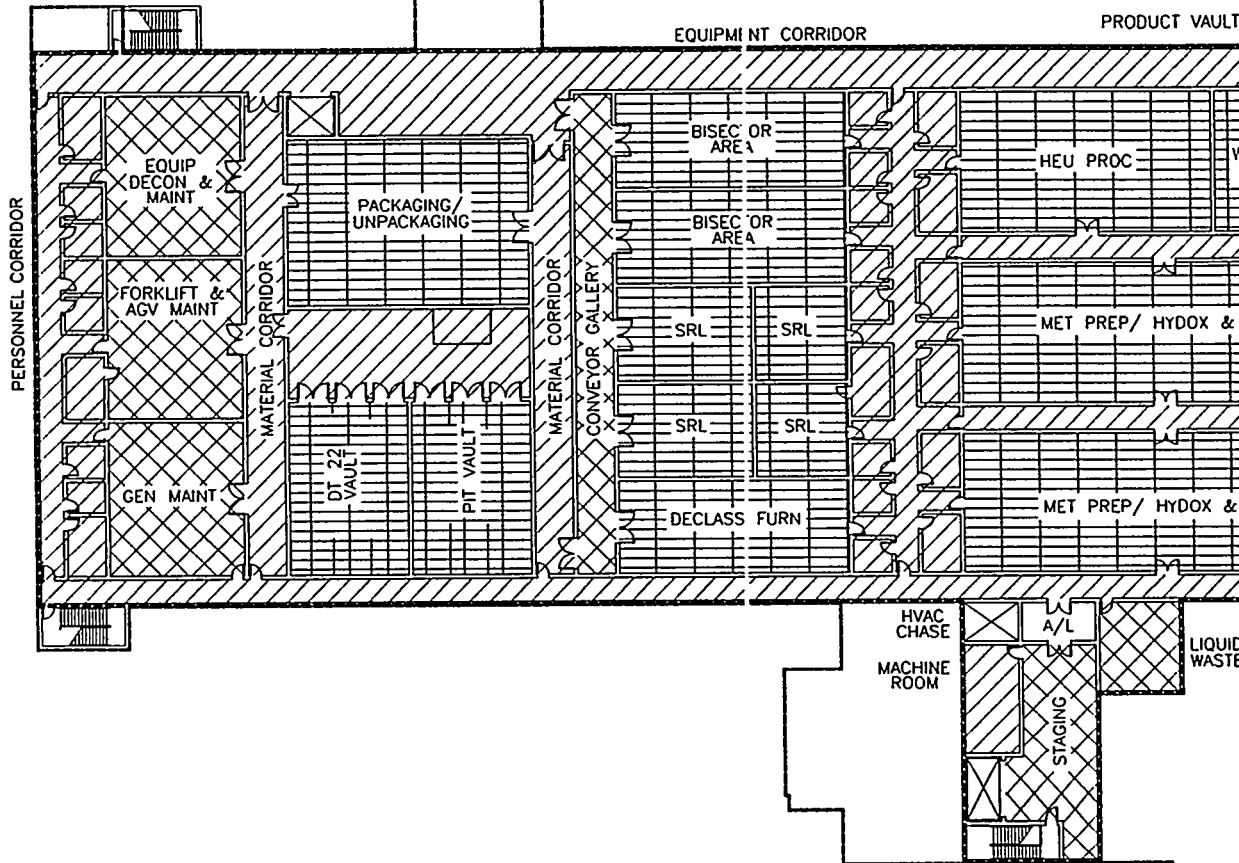

EQUIPMENT CORRIDOR

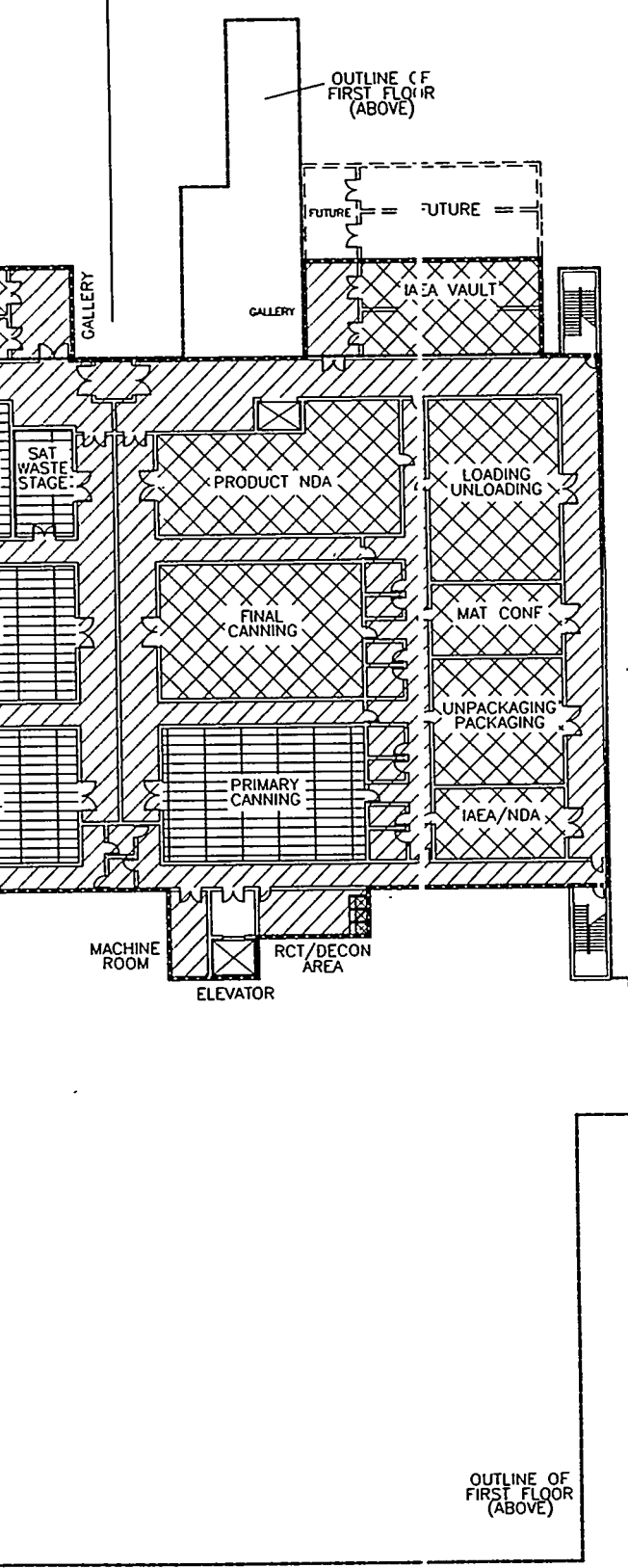

CLASSIFIED | UNCLASSIFIED

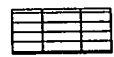
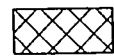
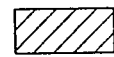

CONFINEMENT LEGEND

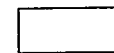
-  ZONE IIB
-  ZONE IIA
-  ZONE III
-  ZONE IV
-  NEUTRAL ZONE

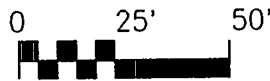

FLUOR DANIEL INC

PIT DISASSEMBLY & CONVERSION FACILITY CONCEPTUAL DESIGN

HVAC CONFINEMENT ZONES M106 BASEMENT LEVEL

REFERENCE BUILDING

Los Alamos Los Alamos National Laboratory Los Alamos, New Mexico 87545

PI: DATE: 11-01-97 PL

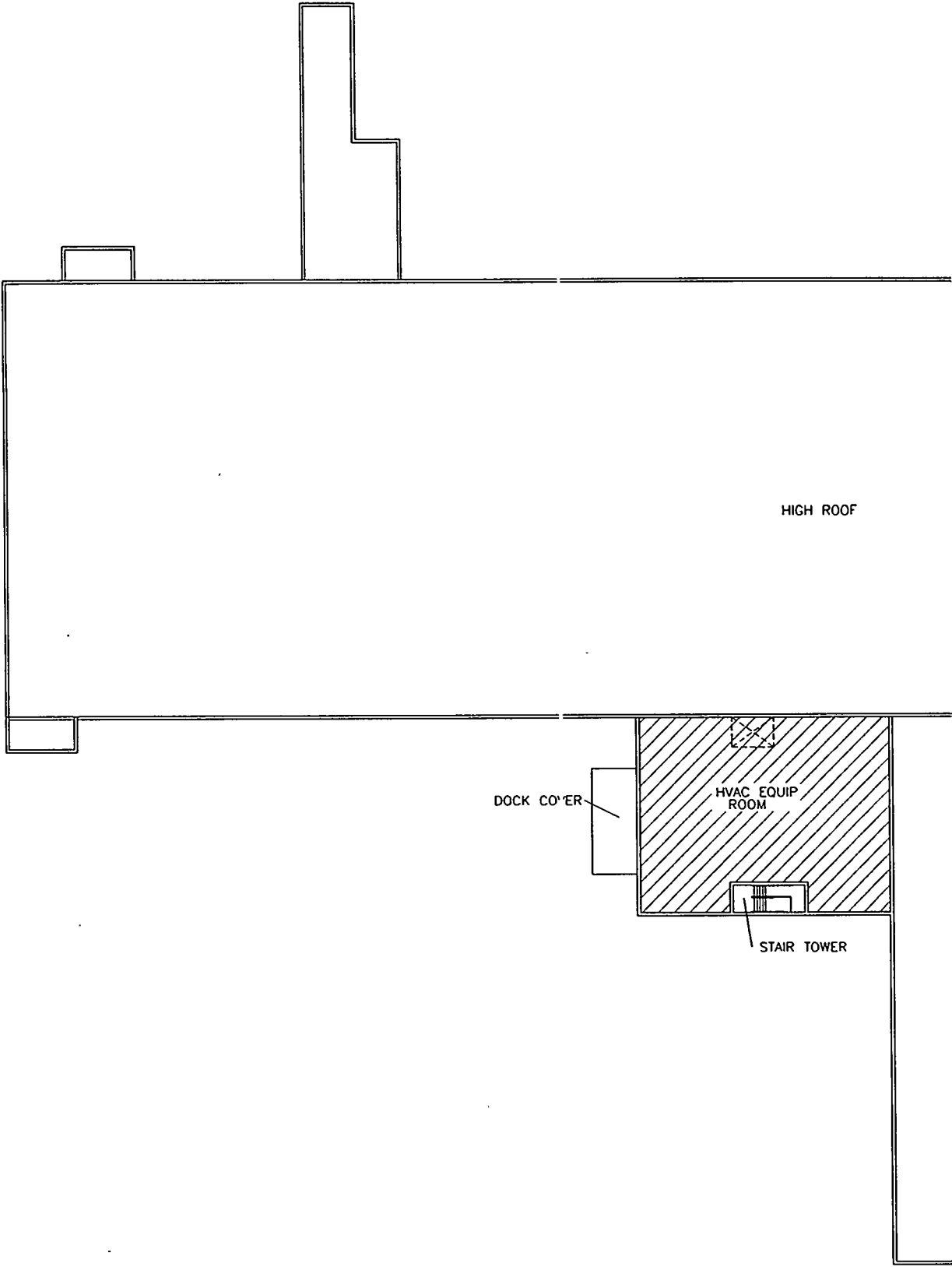

HIGH ROOF



DOCK CO'ER

HVAC EQUIP ROOM

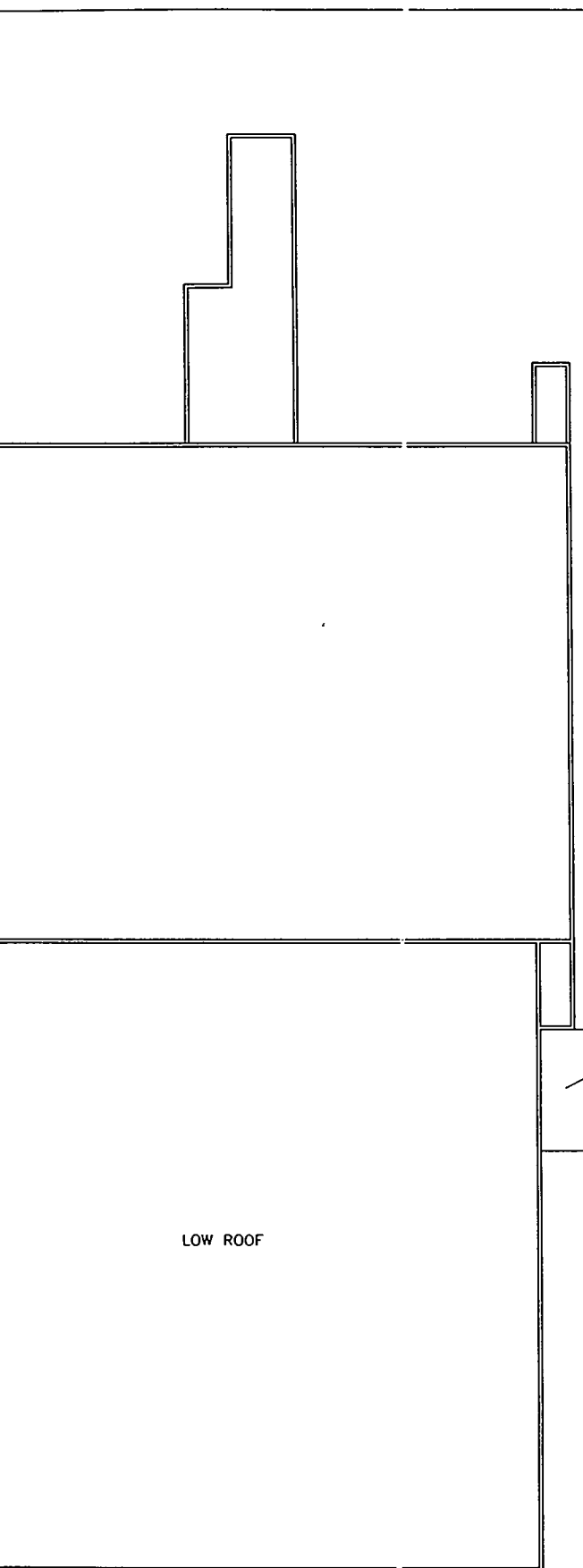
STAIR TOWER

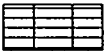

CONFINEMENT LEGEND

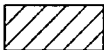
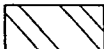
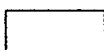
-  ZONE IIB
-  ZONE IIA
-  ZONE III
-  ZONE IV
-  NEUTRAL ZONE

DOCK COVER

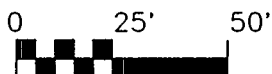

LOW ROOF



FLUOR DANIEL INC

PIT DISASSEMBLY &
CONVERSION FACILITY
CONCEPTUAL DESIGN

HVAC CONFINEMENT ZONES M107
ROOF LEVEL

REFERENCE BUILDING

Los Alamos Los Alamos National Laboratory
Los Alamos, New Mexico 87545

DATE: 11-01-07 PL

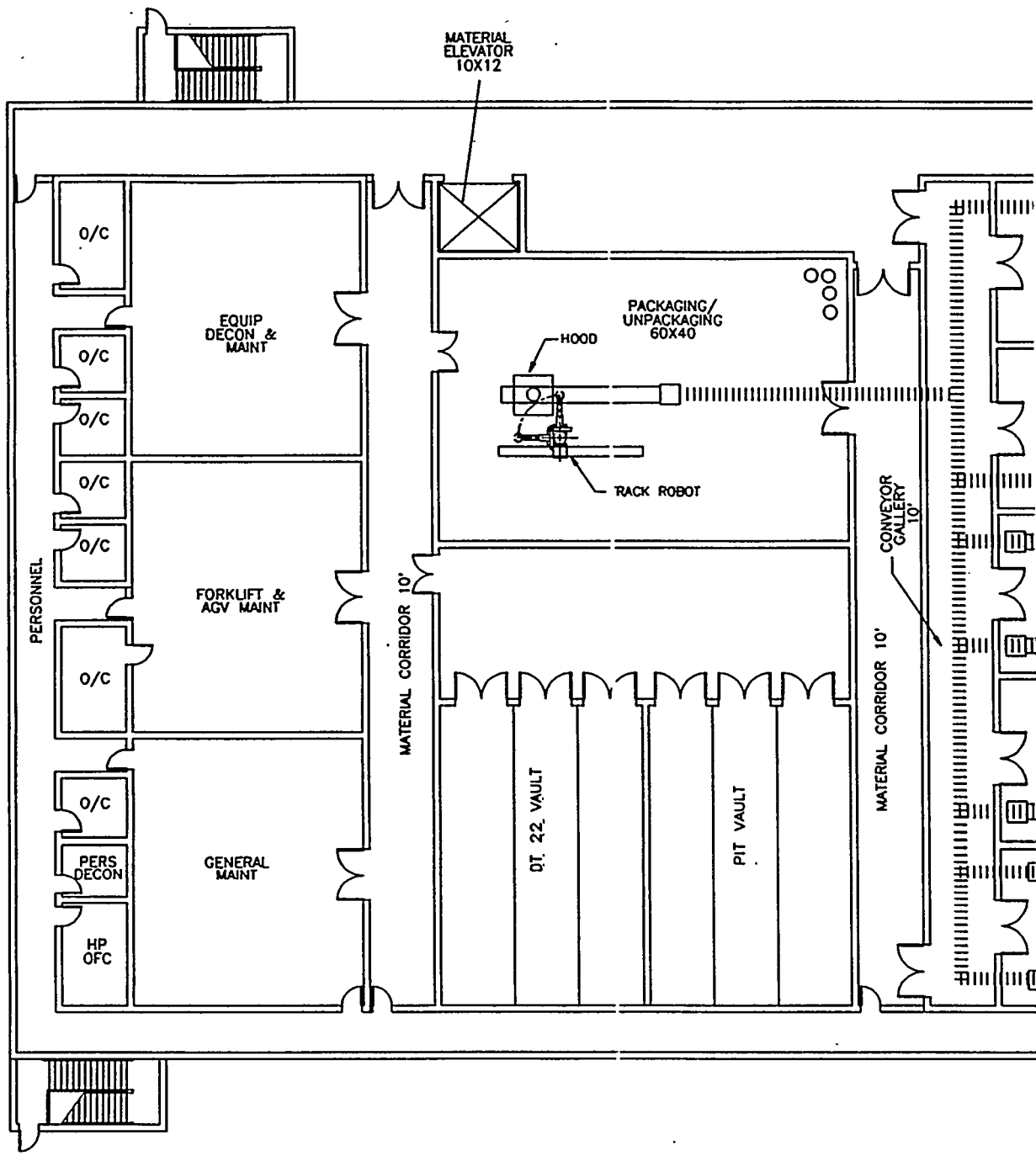

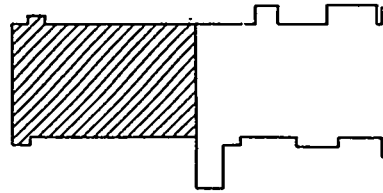
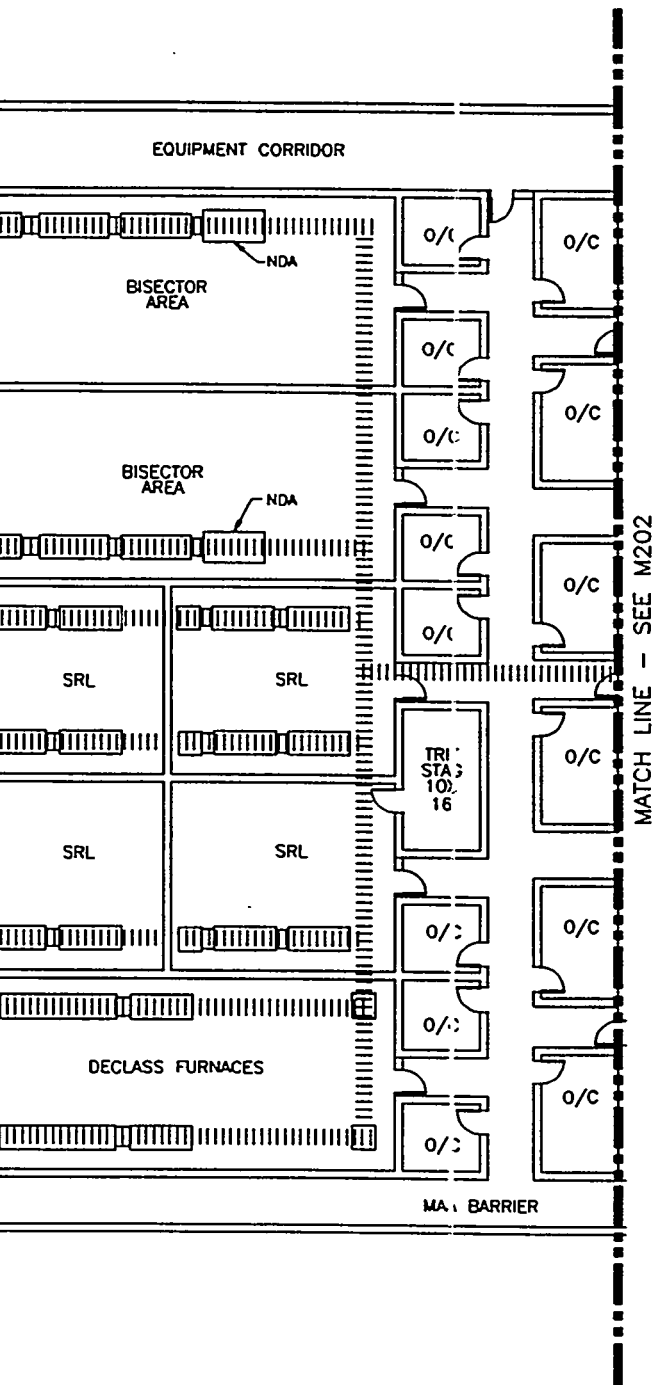

LEGEND

- SRL = SPECIAL RECOVERY LINE
- GRIS = GAMMA RAY ISOTOPIC SYSTEM
- NCC = NEUTRON COINCIDENCE COUNTER
- ||||| = OVERHEAD CONVEYOR
- ▨ = LOWER CONVEYOR
- = VERTICAL CONVEYOR

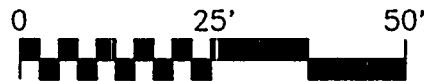

FLUOR DANIEL INC

PIT DISASSEMBLY &
CONVERSION FACILITY
CONCEPTUAL DESIGN

MECH EQUIP PLAN
BASEMENT - NORTH

M201

REFERENCE BUILDING

Los Alamos Los Alamos National Laboratory
Los Alamos, New Mexico 87545

PI: DATE: 11-01-97 PL

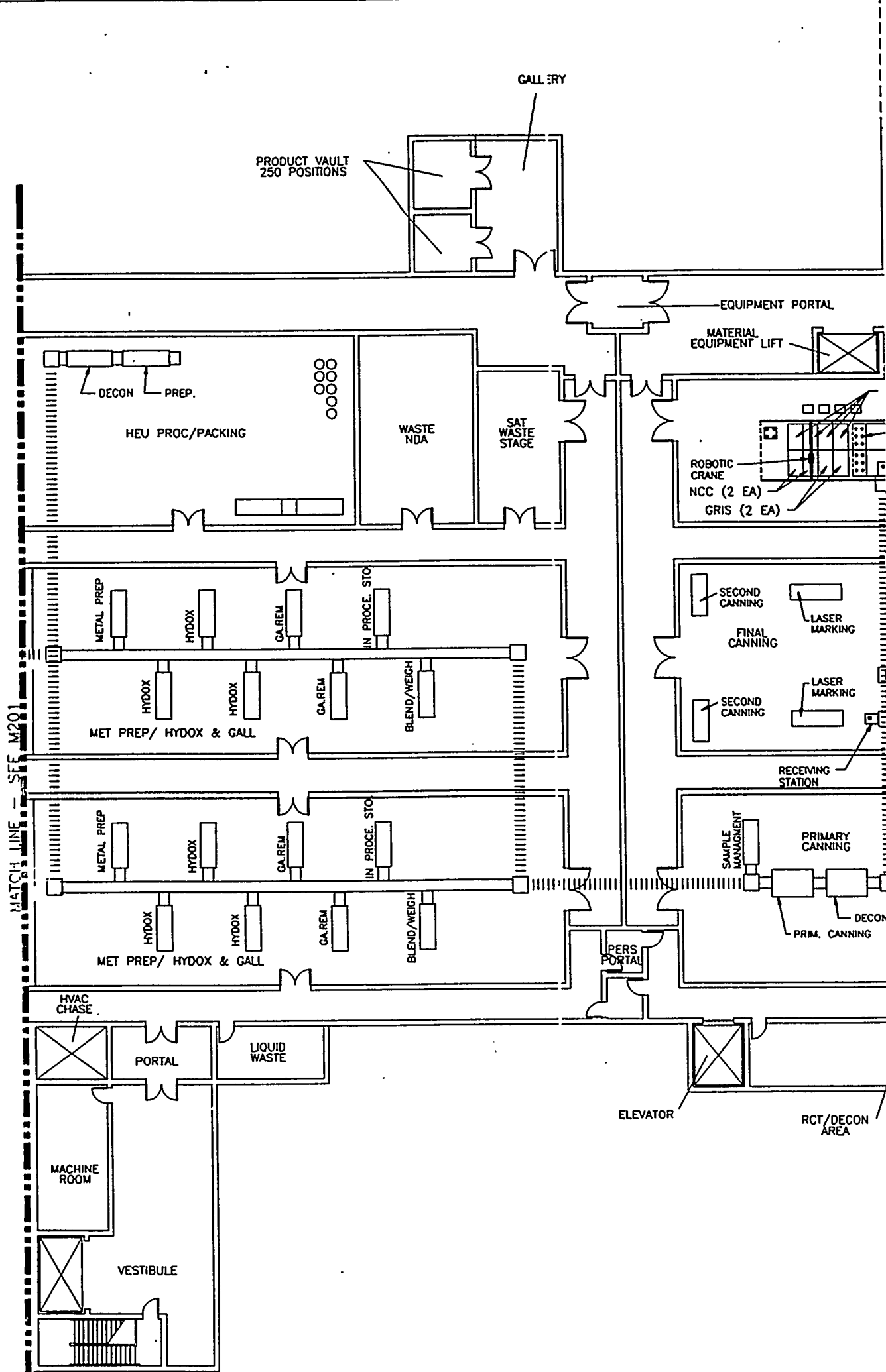

GALLERY

PRODUCT VAULT
250 POSITIONS

EQUIPMENT PORTAL

MATERIAL
EQUIPMENT LIFT

DECON PREP.

HEU PROC/PACKING

WASTE
NDA

SAT
WASTE
STAGE

ROBOTIC
CRANE
NCC (2 EA)
GRIS (2 EA)

SECOND
CANNING
LASER
MARKING
FINAL
CANNING

SECOND
CANNING
LASER
MARKING

RECEIVING
STATION

SAMPLE
MANAGEMENT

PRIMARY
CANNING

DECON
PRM. CANNING

MATCH LINE - SEE M201

METAL PREP

HYDOX

GA-REM

IN PROC. STO

MET PREP/ HYDOX & GALL

BLEND/WEIGH

METAL PREP

HYDOX

GA-REM

IN PROC. STO

MET PREP/ HYDOX & GALL

BLEND/WEIGH

PERS
PORTAL

HVAC
CHASE

PORTAL

LIQUID
WASTE

MACHINE
ROOM

VESTIBULE

ELEVATOR

RCT/DECON
AREA

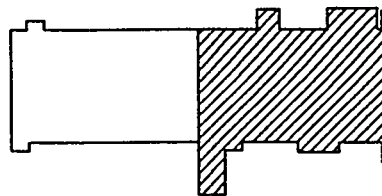
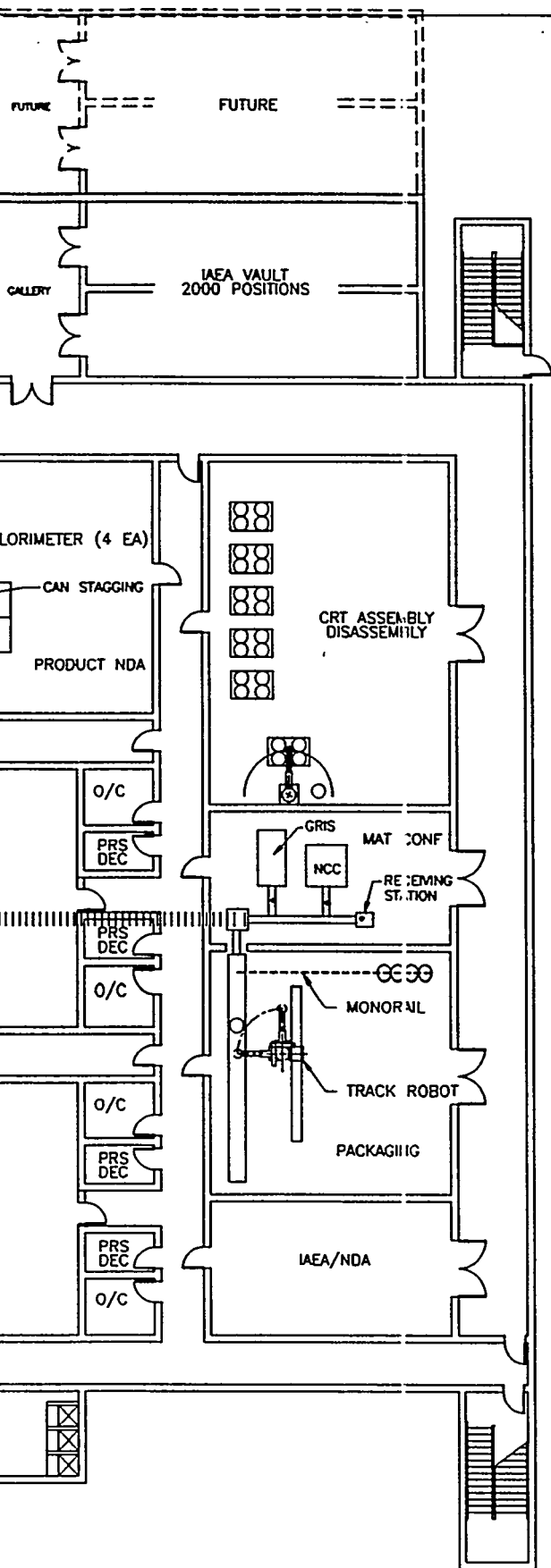

LEGEND

- SRL = SPECIAL RECOVERY LINE
- GRIS = GAMA RAY ISOTOPIC SYSTEM
- NCC = NEUTRON COINCIDENCE COUNTER
- ||||| = OVERHEAD CONVEYOR
- = LOWER CONVEYOR
- = VERTICAL CONVEYOR



FLUOR DANIEL INC

PIT DISASSEMBLY &
CONVERSION FACILITY
CONCEPTUAL DESIGN

MECH EQUIP PLAN
BASEMENT - SOUTH

M202

REFERENCE BUILDING

Los Alamos Los Alamos National Laboratory
Los Alamos, New Mexico 87545

PI: DATE: 11-01-97 PL

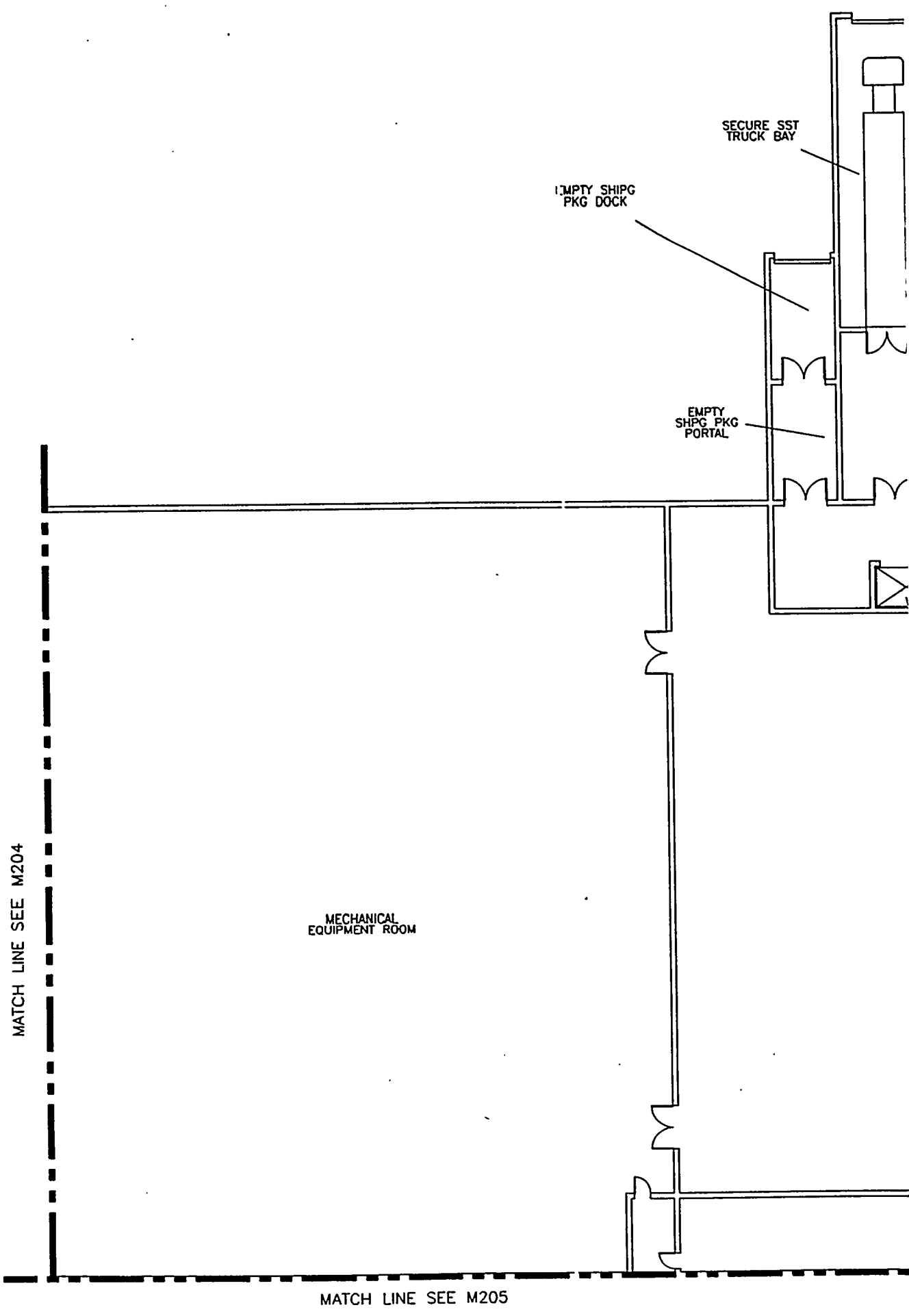

SECURE SST
TRUCK BAY

EMPTY SHIPG
PKG DOCK

EMPTY SHIPG
PKG
PORTAL

MECHANICAL
EQUIPMENT ROOM

MATCH LINE SEE M204

MATCH LINE SEE M205

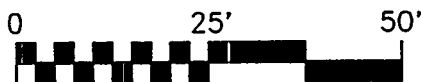
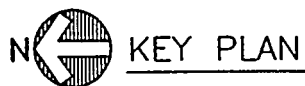
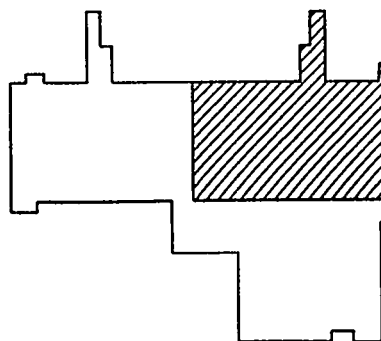
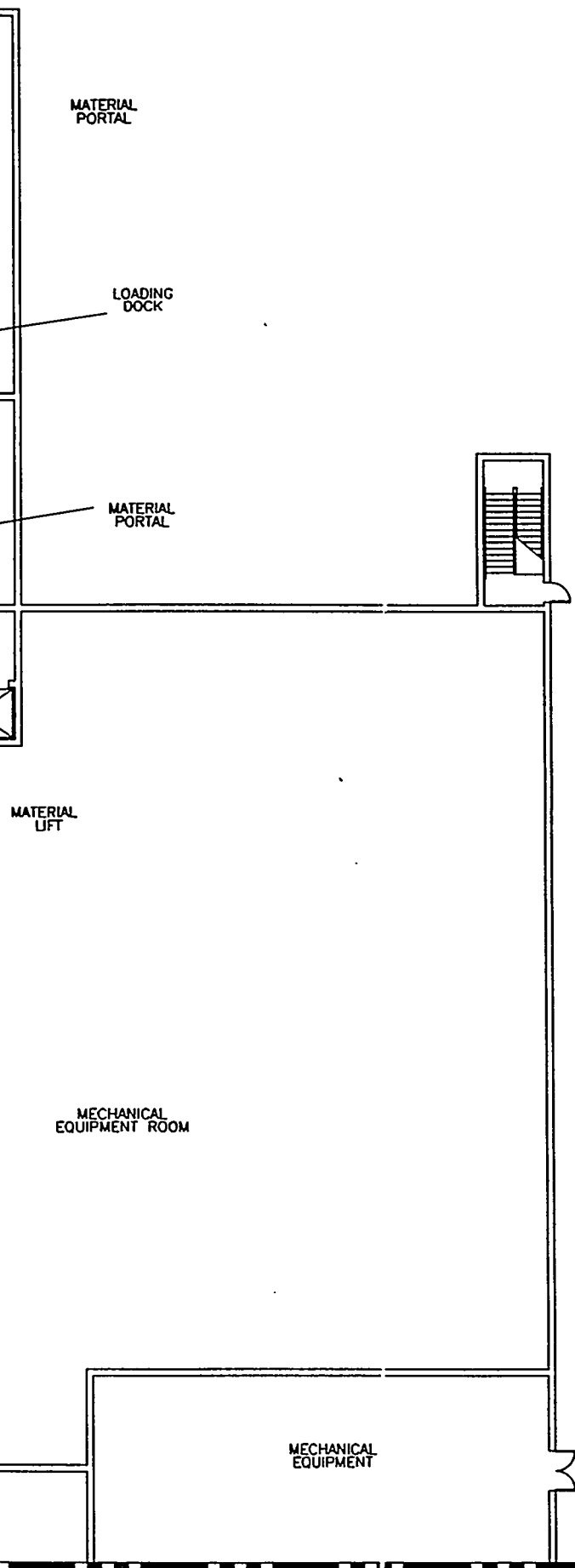

FLUOR DANIEL INC

PIT DISASSEMBLY &
CONVERSION FACILITY
CONCEPTUAL DESIGN

MECH EQUIP PLAN
FIRST FLOOR - SOUTH

M203

REFERENCE BUILDING

Los Alamos Los Alamos National Laboratory
Los Alamos, New Mexico 87545

PI: DATE: 11-01-97 PL

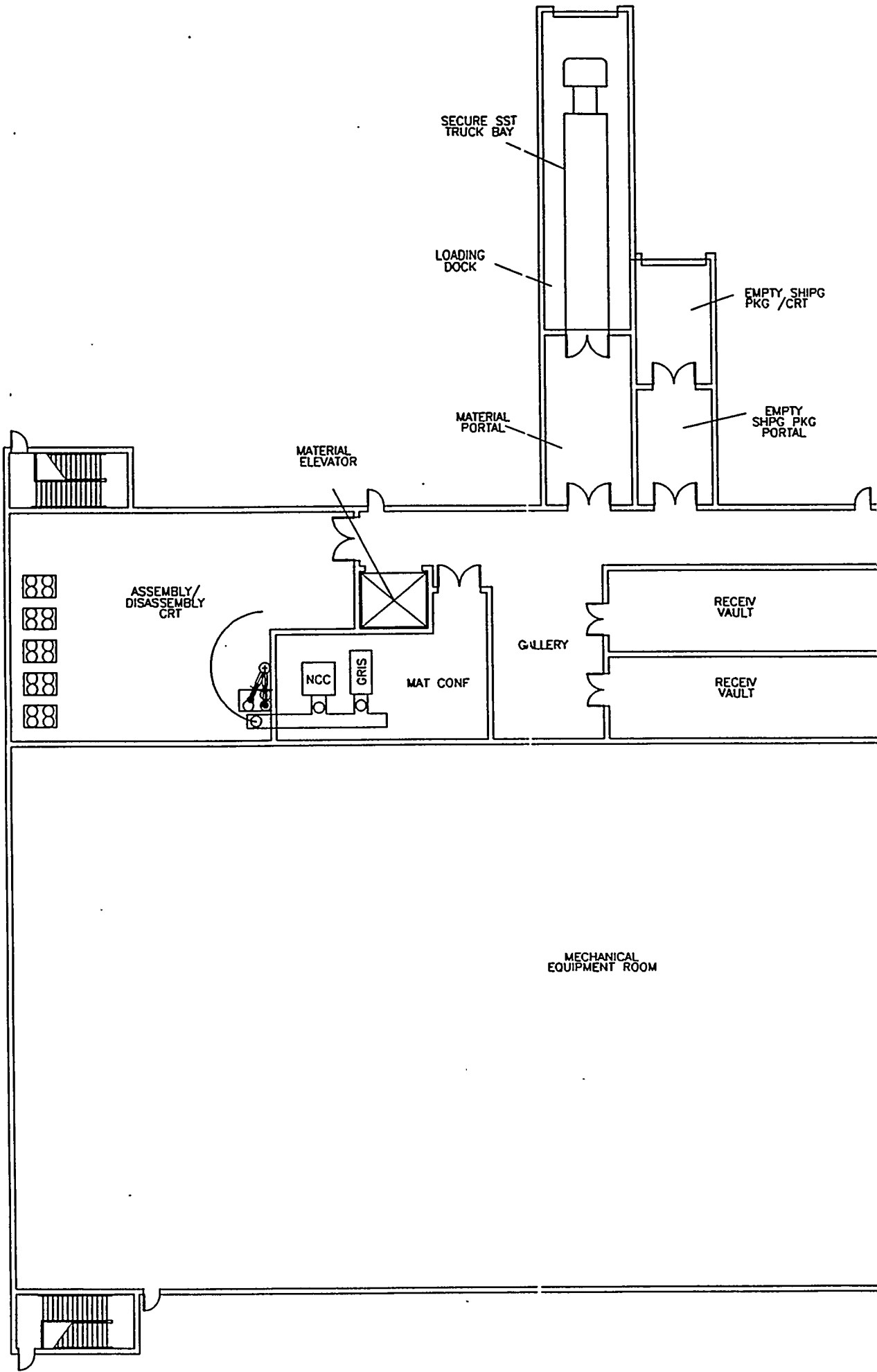

SECURE SST TRUCK BAY

LOADING DOCK

EMPTY SHPG PKG / CRT

EMPTY SHPG PKG PORTAL

MATERIAL ELEVATOR

MATERIAL PORTAL

ASSEMBLY/DISASSEMBLY CRT

RECEIV VAULT

GALLERY

NCC

GRIS

MAT CONF

RECEIV VAULT

MECHANICAL EQUIPMENT ROOM

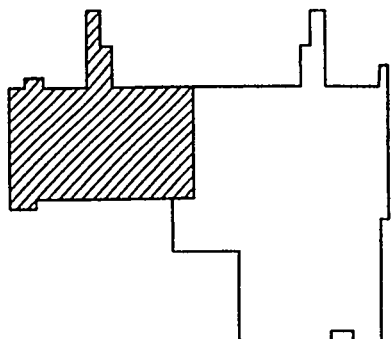

 KEY PLAN

LEGEND
 - LOWER CONVEYOR

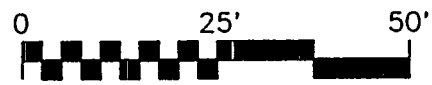
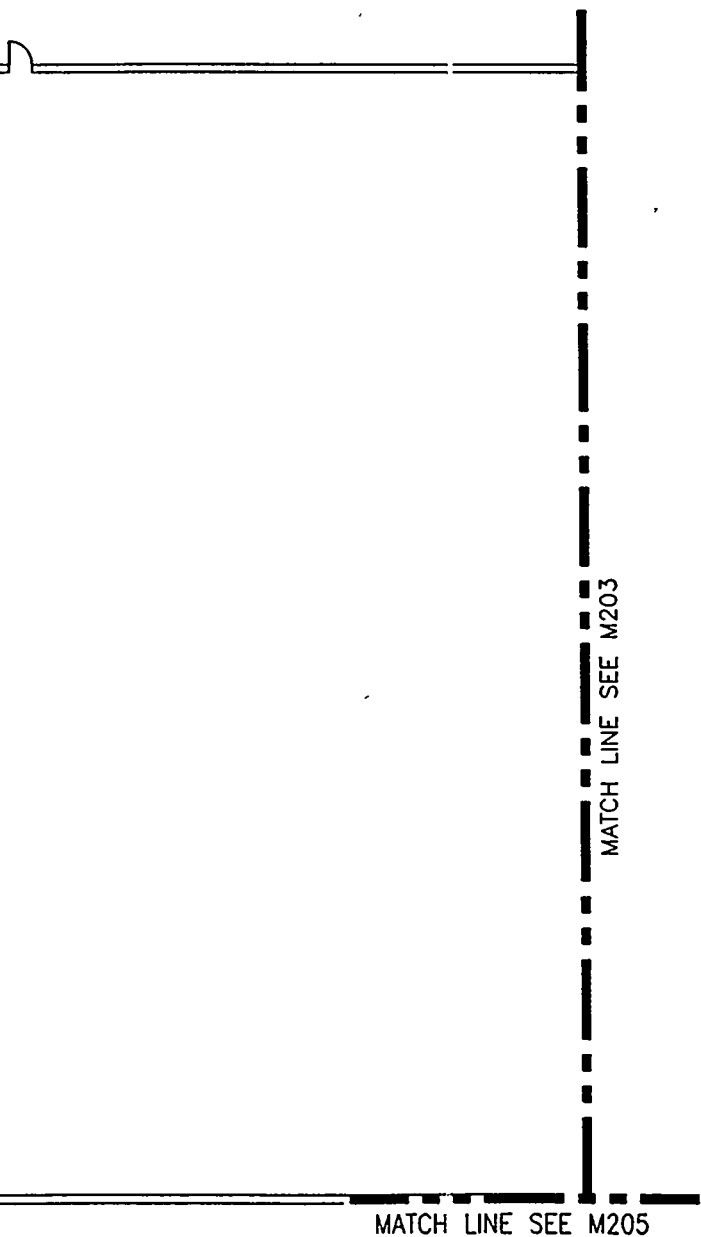

FLUOR DANIEL INC

PIT DISASSEMBLY &
CONVERSION FACILITY
CONCEPTUAL DESIGN

MECH EQUIP PLAN
FIRST FLOOR - NORTH

M204

REFERENCE BUILDING

Los Alamos Los Alamos National Laboratory
Los Alamos, New Mexico 87545

PI: DATE: 11-01-97 PL

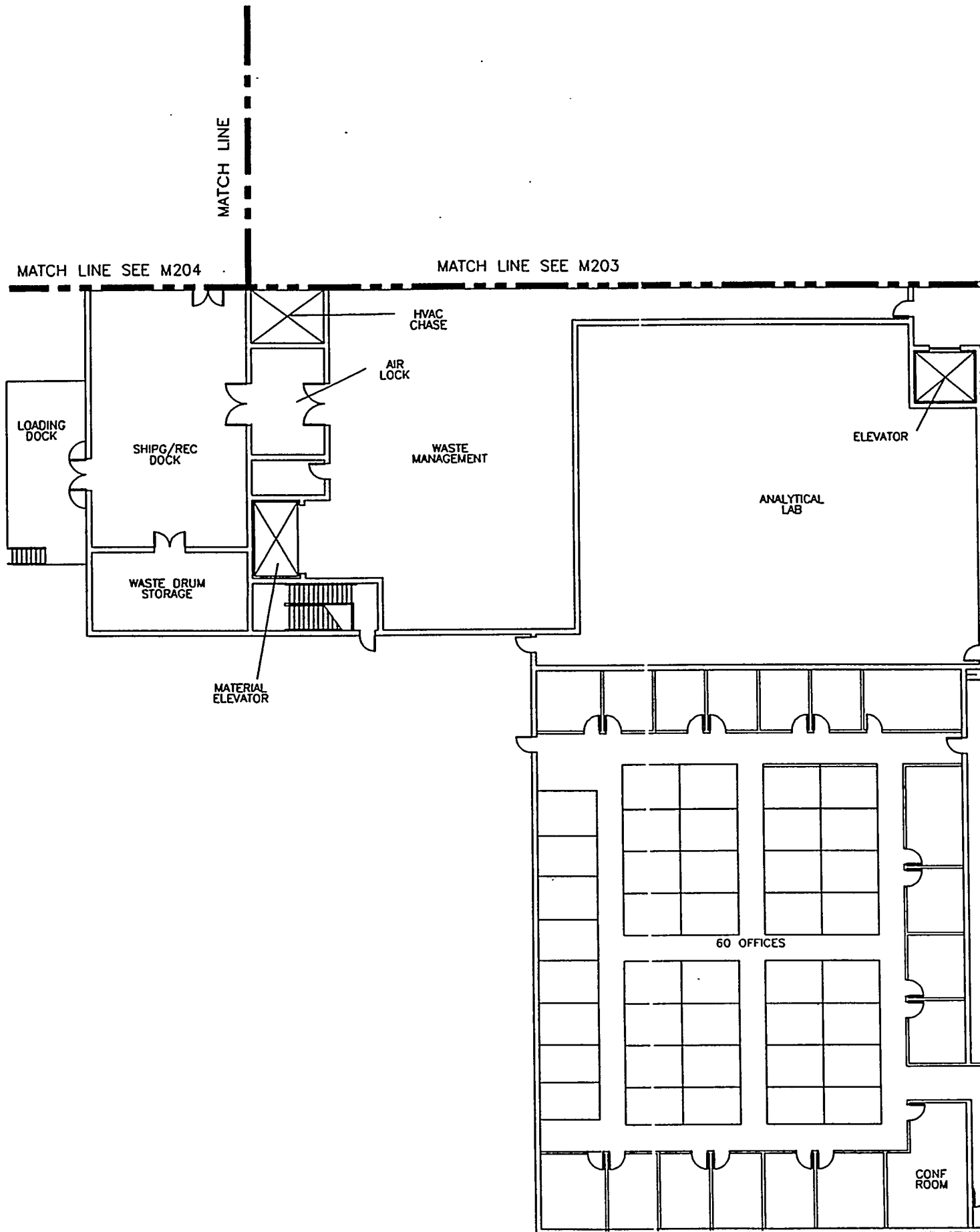

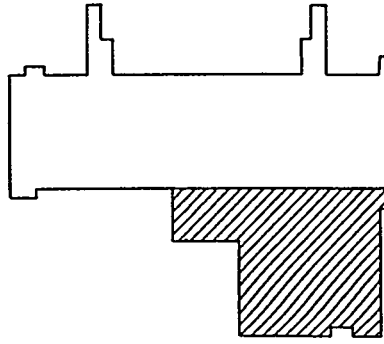

N  KEY PLAN

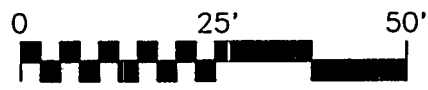
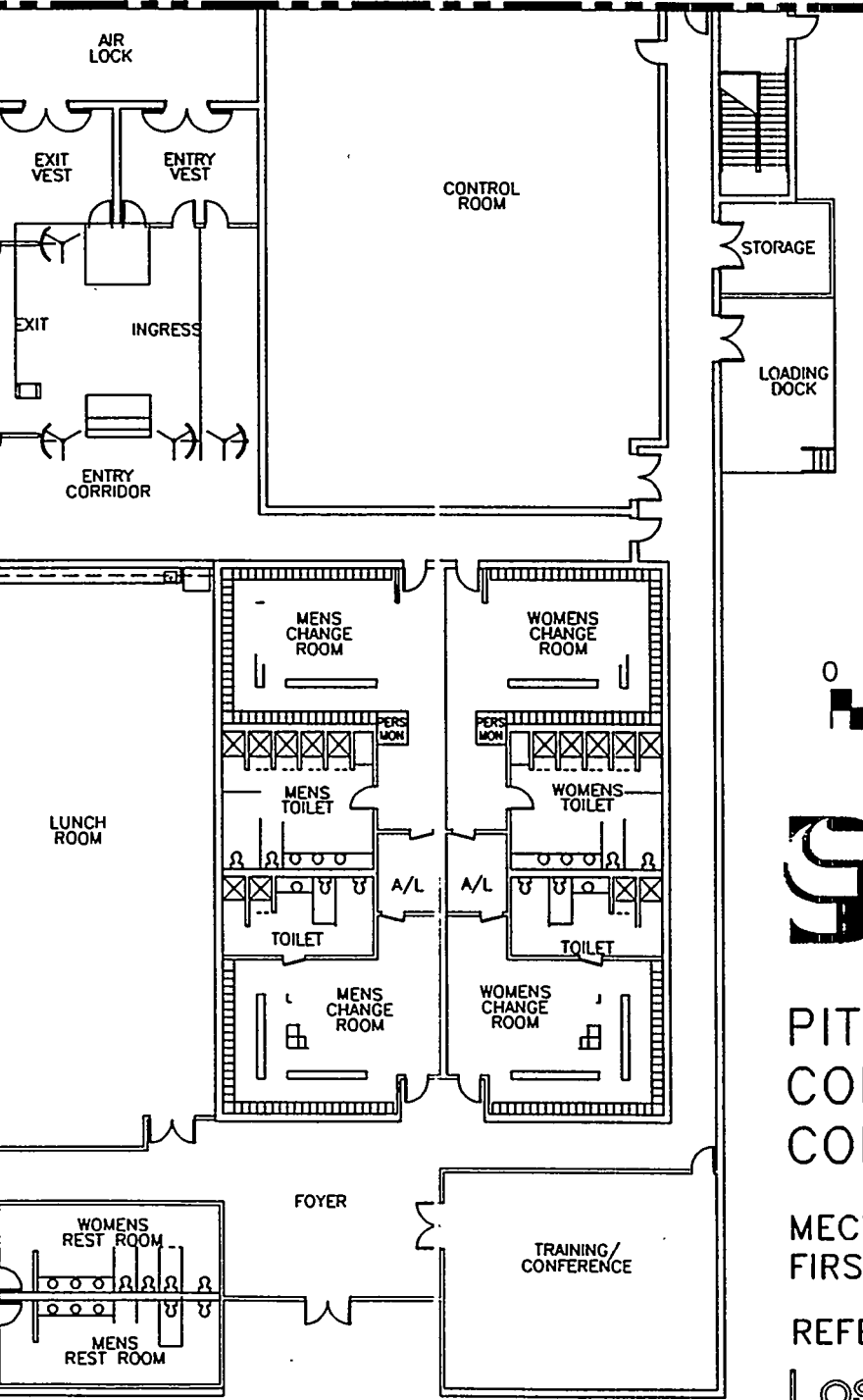

FLUOR DANIEL INC

PIT DISASSEMBLY &
CONVERSION FACILITY
CONCEPTUAL DESIGN

MECH EQUIP PLAN
FIRST FLOOR - WEST

M205

REFERENCE BUILDING

Los Alamos Los Alamos National Laboratory
Los Alamos, New Mexico 87545

PI: DATE: 11-01-97 PL

Appendix C
Conceptual Design Equipment List

EQUIPMENT LIST

Design-only Conceptual Design Report Plutonium Disassembly And Conversion Facility (PDCF)

Equip. Type Code	Equipment Description	Qty	Notes
System: <u>SHIPPING/RECEIVING</u>			
Subsystem: <u>Truck Unloading/Loading</u>			
BC	Station, Battery Charging	2	forklifts
CW	Computer Terminal	1	in CRT handling room
FK	Forklift	2	including shielding
RA	Counter, Alpha/Gamma	2	
RA	Monitor, Neutron	2	
RA	Sample Equipment, Air	2	
TE	Station, Smear Test	2	
Subsystem: <u>CRT Assembly/Disassembly</u>			
BC	Station, Battery, Charging, AGV	2	
HT	Crane, Jib	2	CRT disassembly
TE	Station, Smear Test	2	CRT handling area (instrumentation & robotics)
Subsystem: <u>Unpackaging/Packaging</u>			
CV	Conveyor	2	material confirm
CV	Conveyors	2	unpackaging lines
CW	Computer Controls, AGV	1	software & hardware
GV	AGV	2	material handling
HD	Hood	1	sniff test
HT	Crane, Overhead/robotic	1	accountability measurements
RA	Test Equipment, Sniff	1	tritium
RB	Robots, Track	2	unpackaging/packaging lines
RK	Rack, Storage, Shielded	1	12 position (product containers)
SC	Load Cell	1	
TE	Station, Smear Test	2	complete equip., unpackaging/packaging

**Equip.
Type Code**

Equipment Description

Qty

Notes

System: STORAGE SYSTEMS

Subsystem: Receiving Vault

BC	Station, Battery Charging, AGV	2	one per AGV
CW	Computer Controls, AGV	1	software & hardware
DR	Doors, Vault	8	provide shielding & containment
GV	AGV	1	with telescopic mast
RK	Racks, Warehouse, 1st Floor, Lot	1	110 FL's, 50 DT-22s, 10 cont. pit containers
RK	Racks, Warehouse, Basement, Lot	1	
SC	Load Cell	2	

Subsystem: Production Vaults

DR	Doors, Vault	2	provide shielding & containment
GV	Automated Guided Vehicle	1	with telescopic mast
RK	Racks, Warehouse, Lot	1	250 cans

Subsystem: IAEA Vault

BC	Station, Battery-Charging, AGV	1	
DR	Doors, Vault	2	provide shielding & containment
GV	AGV	1	with telescopic mast
RK	Racks, Warehouse, Lot	1	2000 cans

Equip.
Type Code

	Equipment Description	Qty	Notes
System:	<u>DISASSEMBLY AND OXIDE CONVERSION</u>		
Subsystem:	<u>None</u>		
BL	Blender/Weigher	2	blend/weigh oxide
CV	Conveyor, Lot	1	1 wr. lvl. (HYDOX), 190 LF, include. airlock & ftgs/windows, etc.
CV	Conveyor, Vertical	22	
CV	Conveyors, Lot	1	O.H. conveyors (1200 LF)
DE	Decon System, Electrolytic, Inner can, Lot	1	inner can decontamination
DE	Decon System, HEU, Lot	1	decontaminate HEU
FN	Furnace, Induction	8	metal declassification
FN	Furnace, Induction	4	tritium decontamination
FN	Reactors, HYDOX	12	convert metal to oxide
GB	Glove Boxes, Various Sizes	45	HYDOX, SRL, Decon, Etc.
GR	Gallium Removal Equipment	4	system for gallium removal
MP	Metal Preparation Equipment	2	prep equipment for pit containers
TO	Pit Bisector (System)	4	pit cutting
WL	Welder, Inner Can, Lot	1	welder, leak check
WL	Welder, Outer Can, Lot	2	welding 3013 can/leak check/laser mark.

**Equip.
Type Code**

	Equipment Description	Qty	Notes
System:	<u>LABORATORY SUPPORT</u>		
subsystem:	<u>Analytical Laboratories</u>		
AN	Analyzer, Carbon, Organic, Total	1	
AN	Analyzer, LECO	2	
AQ	Purification System, Argon Gas	1	general lab support
BR	Bench, Radioactive, Lab	5	
BR	Bench, Radioactive, Lab	4	
BR	Bench, Radioactive, Lab	1	
BR	Bench, Radioactive, Lab	2	
BR	Bench, Radioactive, Lab	3	
BR	Bench, Radioactive, Lab	2	
BR	Bench, Radioactive, Lab	6	
BR	Bench, Radioactive, Lab	4	
BR	Bench, Radioactive, Lab	2	
CO	Coulometer, Controlled-Potential	1	
CR	Chromatograph, Gas	1	
CR	Chromatograph, Ion	1	
CR	Chromatograph, Mass-Spec., Gas, (Semivolatiles)	1	
CR	Chromatograph, Mass-Spec., Gas, (Volatiles)	1	
CW	Computer, Mainframe, with Lab Software	1	
CW	Computers, PC, Workstation	16	
CW	Workstation, Computer (Mainframe)	3	
GB	Glove Box, ICP Emission Spectrometer	2	
GB	Glove Box, ICP Mass Spectrometer	2	
GB	Glove Box, Instrumentation	1	
GB	Glove Box, Radioactive Residues	1	residue accumulation
GB	Glove Box, Sample Preparation	2	
GB	Glove Box, Sample Preparation	4	
GB	Glove Box, Solids Receiving	3	sample receiving
GB	Glove Box, Solids Receiving	2	
GB	Glove Box, Standards, High-level	2	analytical support
GB	Glove Box, Standards, Low-level	1	
GB	Glove Box, TCLP Sample Preparation	1	organics analysis lab
HD	Hood	4	
HD	Hood	2	
HD	Hood	3	
HD	Hood	4	
HD	Hood	4	
HD	Hood	1	
LE	Leaching Apparatus, TCLP	2	
PN	Transfer System, Sample, Pneumatic	1	
RA	Counter System, Drum, Gamma, Low-level	1	

**Equip.
Type Code**

	Equipment Description	Qty	Notes
RA	Counter, Alpha, Automated	2	
RA	Counter, Gamma, Automated	1	
RA	Counter, Liquid-scintillation	1	
RA	Counting Sys, High-resolution, Gamma W/Detectors	1	
RA	Counting System, Proportional	1	
RA	Scan System, Gamma, Segmented	2	
RA	Shields, Counting Systems	2	
SE	Scanning Electron Microscope	1	
SE	Spectrometer, Alpha	2	radiochemistry lab
SE	Spectrometer, Emission, ICP-Atomic	1	
SE	Spectrometer, High-Resolution, UV-VIS-NIR	1	
SE	Spectrometer, ICP-Mass	1	
SE	Spectrophotometer, Atomic Absorption	1	trace element analysis lab
SE	Spectrophotometer, Diode Array	1	
SE	Spectrophotometer, Diode Array	1	
SE	Spectrophotometer, IR	1	
SE	Spectrophotometer, IR, Near	1	
TI	Titration, Auto	2	Plutonium assay lab
XR	X-ray, Fluorescence, Energy-dispersive	1	
XR	X-ray, Fluorescence, Wavelength-dispersive	1	

**Equip.
Type Code**

	Equipment Description	Qty	Notes
System:	<u>MATERIAL CONTROL & ACCOUNTABILITY</u>		
subsystem:	<u>None</u>		
CA	Calorimeter, Heat Standard (Nuclear)	2	accountability/verification
CA	Calorimeter, Well	4	oxide accountability/Verification measurement
CW	Computer System, MC&A	1	software & hardware
RA	Counter System, Drum, Gamma, Low-level	1	waste & shipping container monitoring
RA	Counter, Neutron Coincidence	2	confirmation fingerprint measurement (strategic)
RA	Monitoring Equipment, Tritium, Lot	1	
RA	Shuffler, Californium	1	waste & shipping Container monitoring
RA	Shuffler, Californium	2	MAA empty drum portal
RA	Standards, Gamma/Neutron, NDA	2	accountability/verification confirmation
SE	Spectrometer, Isotopic, Gamma	4	accountability/verification measurement
SR	Reader, Bar Code	10	one reader for each SNM reader, whole plant

**Equip.
Type Code**

	Equipment Description	Qty	Notes
System:	<u>WASTE HANDLING</u>		
Subsystem:	<u>Sort & Segregate</u>		
GB	Glove box, Sort and Segregate	1	
PF	Prefilter, Glove box, Sort and Segregate	1	
Subsystem:	<u>Compact & Size Reduce</u>		
GB	Glove box, Compact & Size Reduction	1	
PF	Prefilter, Glove box, Compact & Size Reduction	1	
SR	Size Reduction Equipment	1	
Subsystem:	<u>Chemical Adsorption</u>		
AD	Adsorption Equipment, chemical	1	
GB	Glove box, Chemical adsorption	1	
PF	Prefilter, Glove box, Chemical Adsorption	1	
Subsystem:	<u>Package</u>		
GB	Glove box, Package	1	
PF	Prefilter, Package	1	
PK	Packaging Equipment	1	
Subsystem:	<u>Assay Solid</u>		
RA	Counter, Drum, Neutron	1	
RA	Load Cell	1	
RA	Scanner, Drum, Low-level Gamma	1	
Subsystem:	<u>Hold Sample (Liquid)</u>		
PP	Pump, Hold Tank	1	
PP	Pump, Hold Tank	1	
TK	Tank, Hold, MAA LLW	1	
TK	Tank, Hold, Waste Management	1	

Equip.
Type Code

Equipment Description Qty Notes

System: WASTE HANDLING (continued)

Subsystem: Process Evaporation

CL	Cooler, Inlet-stream	1	
CR	Condenser	1	
EV	Evaporator	1	
GB	Glove box, Evaporation	1	
PF	Prefilter, Evaporation	1	
PP	Pump, Bottoms-tank	1	
PP	Pump, Condensate-hold	1	
PP	Pump, Condenser	1	
PP	Pump, Evaporator	1	
TK	Adjustment System, pH, Tank & Metering Pump	1	
TK	Tank, Bottoms	1	
TK	Tank, Condensate-hold	1	

Subsystem: Certify Package

RA	Load Cell	1	
----	-----------	---	--

Appendix D
Project Schedule

ID #	DESCRIPTION	DURATION	START	FINISH	1999	2000	2001	2002	2003	2004	2005
ENGINEERING DESIGN (TITLE I)					01	02	03	04	01	02	03
+ A/E MANAGEMENT (TITLE I)					01	02	03	04	01	02	03
		224	02NOV98	30SEP99							
FACILITY DESIGN											
PD40	Geotechnical Investigation Support	5	02NOV98*	06NOV98							
PD50	Preliminary Shielding Analysis	155	02NOV98	23JUN99							
PD48	Structural Engineering Basis of Design	8	11DEC98*	22DEC98							
PD05	Site Development Design	69	19JAN99	26APR99							
PD10	Process Facility General Arrangements	40	19JAN99	16MAR99							
PD15	Support Facility General Arrangements	55	19JAN99	06APR99							
PD25	Communication System Drawings	5	17MAR99	23MAR99							
PD45	Building Structural Analysis	98	07APR99	24AUG99							
PD46	General Structural Engineering & Drawings	75	07APR99	22JUL99							
PD20	Electrical Primary Distribution Drawings	30	03JUN99	15JUL99							
PD35	Safeguards & Security System Drawings	60	23JUN99	16SEP99							
PD30	Fire Detection / Protection Drawings	5	05AUG99	11AUG99							
PROCESS DESIGN											
PR07	Process Flow Diagrams PFD's	35	01DEC98*	28JAN99							
PR10	Piping & Instrumentation Diagram, P&ID's	169	04JAN99*	01SEP99							
PR15	Utility Load Lists	20	04JAN99	01FEB99							
PD47	Seismic Design & Quails of Systems & Component	15	17MAR99	06APR99							
PR20	System Descriptions	30	30JUL99*	10SEP99							
MECHANICAL DESIGN											
PR21	Mechanical Design Basis Document	3	18DEC98*	22DEC98							
PR25	Material Handling Drawings	8	23DEC98	12JAN99							
PR30	Equipment Layouts	8	13JAN99	25JAN99							

PDCF PRELIMINARY SCHEDULE

Project Start: 01NOV98
 Project Finish: 01OCT04
 Date Issued: 01NOV98
 Issue By: 1201079

PDCF
 Project Start: [Bar Chart] Early Bar
 Project Finish: [Bar Chart] Freeze Bar
 Date Issued: [Bar Chart] Critical Activity

ID #	DESCRIPTION	DURATION	START	FINISH	2000																						
					Q1	Q2	Q3	Q4	Q1	Q2	Q3	Q4	Q1	Q2	Q3	Q4											
PR35	HVAC Zone Drawings	10	26JAN99	08FEB99	✓																						
PR37	Miscellaneous HVAC Activities	10	09FEB99	23FEB99	✓																						
PR40	HVAC Flow and Control Drawings	134	24FEB99	01SEP99																							
PR45	Piping Drawings - Utilities/Services	108	01APR99*	01SEP99																							
PR60	Equipment List	5	01JUL99*	08JUL99	✓																						
PR65	Piping Drawings Fire Protections	2	05AUG99	06AUG99	✓																						
ELECTRICAL DESIGN																											
PR70	Electrical Single Line	30	07APR99	18MAY99																							
PR80	Load List	10	19MAY99	02JUN99	✓																						
PR85	DCS Development	13	03JUN99	21JUN99	✓																						
PR90	DCS Drawings	13	22JUN99	09JUL99	✓																						
PR95	HPS Development	13	12JUL99	28JUL99	✓																						
SF35	Electrical Outline Specs	32	12JUL99	24AUG99	✓																						
PR9905	HPS Drawings	5	29JUL99	04AUG99	✓																						
PR9910	Fire Detection/Protection - Electrical Drawgs.	5	05AUG99	11AUG99	✓																						
SPECIFICATIONS																											
SF46	General Engineering: Cables/Prepare UPS Loads	15	02NOV98*	23NOV98	✓																						
SF15	Structural/Civil Outline Specifications	26	23DEC98	08FEB99	✓																						
SF10	Process Outline Specifications	40	04JAN99*	02MAR99	✓																						
SF11B	Process Equipment Data Sheets	85	03MAY99*	31AUG99																							
SF40	Prepare Summary Load Analysis	15	03JUN99	23JUN99	✓																						
SF05	Plant Equipment Outline Specifications	23	09JUL99	10AUG99	✓																						
SF20	Fire Protection Specifications	5	05AUG99	11AUG99	✓																						
SF11	Piping Line Class Specifications	3	09AUG99	11AUG99	✓																						
SF45	Control Console Details/Layout	5	25AUG99	31AUG99	✓																						
SF25	Physical Security Specifications	10	17SEP99	30SEP99	✓																						

PDCF PRELIMINARY SCHEDULE

1999	2000	2001	2002	2003	2004	2005
01	02	03	04	01	02	03
01	02	03	04	01	02	03
01	02	03	04	01	02	03
01	02	03	04	01	02	03

ID #	DESCRIPTION	DURATION	START	FINISH
SYSTEMS ENGINEERING				
SR04	Value Engineering Process and Report	20	02NOV98*	02DEC98
SR05	Project Design Guide/Std/Require. ID Docmnt.	25	03DEC98	15JAN99
SR10	RAMI / FMECA	100	19JAN99	09JUN99
SP29	Vulnerability Assessment	40	27APR99	22JUN99
SR27	Life Safety Review of Floor Plan	10	27APR99	10MAY99
SR35	PSAR Support	28	06MAY99	15JUN99
SR40	Preliminary Hazards Analysis Support	13	06MAY99*	24MAY99
SR15	Interface Control Documents/Drawings	40	10JUN99	05AUG99
SR25	DB Fire Analysis, Fire Hazards Analysis	30	06AUG99	17SEP99
SR26	Process Discipline Basis for Design	10	30AUG99*	13SEP99
SR30	Preliminary Design Report Complete	21	01SEP99	30SEP99

2000	2001	2002	2003	2004	2005
01	02	03	04	01	02
01	02	03	04	01	02
01	02	03	04	01	02
01	02	03	04	01	02

ID #	DESCRIPTION	DURATION	START	FINISH
ENGINEERING DESIGN (TITLE II)				
DETAILED DESIGN				
A/E/TASK MANAGEMENT - TITLE II				
TZ2A01	A/E Task Management - Title II	454	01OCT99*	29JUN01
SITE DESIGN				
TZ505	Site Design	454	01OCT99*	29JUN01
PROCESS / BUILDING STRUCTURAL PACKAGE				
TZ5P05	Process Building Structural Package	454	01OCT99*	29JUN01
PROCESS BUILDING MECHANICAL INTERNALS				
TZ5M05	Process Building Mechanical Package	454	01OCT99*	29JUN01
PROCESS BUILDING ELECTRICAL				
TZ5B05	Process Building Electrical Internals Package	454	01OCT99*	29JUN01
PROCESS BUILDING ARCHITECTURAL				
TZ5A05	Process Building Architectural Package	454	01OCT99*	29JUN01
PROCUREMENT PACKAGES				
TZ1P05	Process Building Procurement Packages	454	01OCT99*	29JUN01

Sheet 3 of 4

PDCF PRELIMINARY SCHEDULE

Project Start Project Finish Date Start Date End	01NOV98 01OCT00 01NOV98 15DEC97	Project Start Early Start Program Start Critical Activity	PDCF
---	--	--	------

© Primavera Systems, Inc.

1999	2000	2001	2002	2003	2004	2005
01 02 03 04	01 02 03 04	01 02 03 04	01 02 03 04	01 02 03 04	01 02 03 04	01 02 03 04

ID #	DESCRIPTION	DURATION	START	FINISH
ENGINEERING DESIGN (TITLE I)				
+ A/E MANAGEMENT (TITLE I)				
		224	02NOV98	30SEP99
FACILITY DESIGN				
PD40	Geotechnical Investigation Support	5	02NOV98*	06NOV98
PD50	Preliminary Shielding Analysis	155	02NOV98	23JUN99
PD48	Structural Engineering Basis of Design	8	11DEC98*	22DEC98
PD05	Site Development Design	69	19JAN99	26APR99
PD10	Process Facility General Arrangements	40	19JAN99	16MAR99
PD15	Support Facility General Arrangements	55	19JAN99	06APR99
PD25	Communication System Drawings	5	17MAR99	23MAR99
PD45	Building Structural Analysis	98	07APR99	24AUG99
PD46	General Structural Engineering & Drawings	75	07APR99	22JUL99
PD20	Electrical Primary Distribution Drawings	30	03JUN99	15JUL99
PD35	Safeguards & Security System Drawings	60	23JUN99	16SEP99
PD30	Fire Detection / Protection Drawings	5	05AUG99	11AUG99

PROCESS DESIGN				
PR07	Process Flow Diagrams PFD's	35	01DEC98*	28JAN99
PR10	Piping & Instrumentation Diagram, P&ID's	169	04JAN99*	01SEP99
PR15	Utility Load Lists	20	04JAN99	01FEB99
PD47	Seismic Design & Quails of Systems & Component	15	17MAR99	06APR99
PR20	System Descriptions	30	30JUL99*	10SEP99
MECHANICAL DESIGN				
PR21	Mechanical Design Basis Document	3	18DEC98*	22DEC98
PR25	Material Handling Drawings	8	23DEC98	12JAN99
PR30	Equipment Layouts	8	13JAN99	25JAN99

Sheet 1 of 4	
--------------	--

PDCP PRELIMINARY SCHEDULE

Project Start: 01NOV98
Project End: 01NOV98
Task Start: 01NOV98
Task End: 12NOV98

PDCP

Early Start
Project Start
Project End
Task Start
Task End

© Primavera Systems, Inc.

Appendix E
Cost Summary Reports

University of California

Fluor Daniel, Inc.



Los Alamos National Laboratory
A-E/Partnering Services

Project Title: PDCF Facility ROMTPC (Rev.002)
Project Number: PDCF PANTEX (80495-510)

Date: 12-12-97
Time: 10:13:30 AM

CPDS - CPDS Summary Form

ITEM DESCRIPTION	SUBTOTAL	TOTAL COST
------------------	----------	------------

09.A. Design & Management Costs

1.0 Preliminary & Final Design

1.1 Engineering Design.

1.1.1 Preliminary Design (Title I).

Facility Design	995,751
Process Design	2,222,955
Mechanical Design	1,161,265
Electrical Design	485,000
Specifications	733,934
Systems Engineering	3,483,466

1.2.2 Preliminary Design (Title I)	9,062,371
------------------------------------	-----------

1.1.2 Detail Design (Title II).

Site Design	1,094,747
Process/Building Structural package	1,322,236
Process Building Mechanical Internals Package	4,750,720
Process Building Electrical Internals Package	1,514,086
Process Building Architectural	562,715
Procurement Packages (Breakout SFE List)	360,477
Support Facilities Design	1,179,976
Systems Engineering	4,111,682

1.2.3 Detail Design (Title II)	14,896,639
--------------------------------	------------

1.2 Engineering Design.	23,979,010
-------------------------	------------

University of California

Fluor Daniel, Inc.



Los Alamos National Laboratory
A-E/Partnering Services

Project Title: PDCF Facility ROMTPC (Rev.002)
Project Number: PDCF PANTEX (80495-510)

Date: 12-12-97
Time: 10:13:30 AM

CPDS - CPDS Summary Form

ITEM DESCRIPTION	SUBTOTAL	TOTAL COST
------------------	----------	------------

09.A.1 Preliminary & Final Design	23,979,010
-----------------------------------	------------

09.A.2 Design Management

1 Engineering Design,

1.1 Preliminary Design (Title I),

A/E Management (Title I) 3,413,371

1.2.2 Preliminary Design (Title I)	3,413,371
------------------------------------	-----------

1.2 Detail Design (Title II),

A/E Management (Title II) 5,990,437

1.2.3 Detail Design (Title II)	5,990,437
--------------------------------	-----------

1.2 Engineering Design	9,403,808
------------------------	-----------

09.A.2 Design Management	9,403,808
--------------------------	-----------

09.A.3 Project Management

1.1 Project Management,

1.1.1 Design Project Management

Organization	2,010,000
Staffs	112,500
Plans	480,000
Finances	480,000
Directions	150,000
Coordination	300,000
Reports	375,000

1.1.1 Design Project Management	3,907,500
---------------------------------	-----------

University of California

Fluor Daniel, Inc.



Los Alamos National Laboratory
A-E/Partnering Services

Date: 12-12-97
Time: 10:13:30 AM

Project Title: PDCF Facility ROMTPC (Rev.002)
Project Number: PDCFPA NTEX (80495-510)

CPDS - CPDS Summary Form

ITEM DESCRIPTION	SUBTOTAL	TOTAL COST
------------------	----------	------------

1 1 2 Project Management Related to Construction

Project Management Related to Construction 7,584,897

1 1 2 Project Management Related to Construction	7,584,897
--	-----------

1 1 Project Management	11,492,397
------------------------	------------

09 A 3 Project Mangement	11,492,397
--------------------------	------------

09.B. Land & Land Rights

09.B.2 Buildings & Improvements to Land

Procurement.
Procurement.

Procurement 48,353,788

1 3 0 Procurement	48,353,788
-------------------	------------

1 3 Procurement	48,353,788
-----------------	------------

1 4 Construction

1 4 2 Site Preparation Package

Site Preparation Package 8,131,738

1 4 2 Site Preparation Package	8,131,738
--------------------------------	-----------

1 4 4 Process Facility Package

Process Facility Package 76,147,483

1 4 4 Process Facility Package	76,147,483
--------------------------------	------------

1 4 5 Support Facilities Package

Support Facilities Package 36,771,991

1 4 5 Support Facilities Package	36,771,991
----------------------------------	------------

1 4 Construction	121,051,213
------------------	-------------

University of California

Fluor Daniel, Inc.



Los Alamos National Laboratory
A-E/Partnering Services

Date: 12-12-97
Time: 10:13:30 AM

Project Title: PDCF Facility ROMTPC (Rev.002)
Project Number: PDCFPA NTEX (80495-510)

CPDS - CPDS Summary Form

ITEM DESCRIPTION	SUBTOTAL	TOTAL COST
------------------	----------	------------

09.B.2 Buildings & Improvements to Land	169,405,001
---	-------------

09.B.6 Insp., Design & Project Liason, Test/Checkout

- 1 Engineering Design.
- 1.4 Inspection (Title III).

Construction Support (Title III) 8,969,840

1.2.4 Inspection (Title III)	8,969,840
------------------------------	-----------

1.2 Engineering Design	8,969,840
------------------------	-----------

09.B.6 Insp., Design & Project Liason, Test/Checkout	8,969,840
--	-----------

09.B.7 Construction Management

- Construction.
- 1.1 Construction Management & Inspection.

Construction Management & Inspection 16,308,800

1.4.1 Construction Management & Inspection	16,308,800
--	------------

1.4 Construction	16,308,800
------------------	------------

09.B.7 Construction Management	16,308,800
--------------------------------	------------

09.C. Contingencies

09.C.1 Design Phase Contingencies

- 1.1 Project Management.
- 1.1 Design Project Management

Design PM Contingency 1,758,375

1.1.1 Design Project Management	1,758,375
---------------------------------	-----------

1.1 Project Management	1,758,375
------------------------	-----------

University of California

Fluor Daniel, Inc.



Los Alamos National Laboratory
A-E/Partnering Services

Date: 12-12-97
Time: 10:13:30 AM

Project Title: PDCF Facility ROMTPC (Rev.002)
Project Number: PDCF PANTEX (80495-510)

CPDS - CPDS Summary Form

ITEM DESCRIPTION	SUBTOTAL	TOTAL COST
1.2 Engineering Design,		
1.2.1 Preliminary Design (Title I),		
A/E Management (Title I)	555,786	
Facility Design	227,043	
Process Design	663,366	
Mechanical Design	350,075	
Electrical Design	144,980	
Specifications	255,199	
Systems Engineering	788,517	
1.2.2 Preliminary Design (Title I)		2,984,967
1.2.3 Detail Design (Title II),		
A/E Management (Title II)	894,710	
Site Design	255,268	
Process/Building Structural package	350,323	
Process Building Mechanical Internals Package	1,428,220	
Process Building Electrical Internals Package	393,363	
Process Building Architectural	144,224	
Procurement Packages (Breakout SFE List)	42,337	
Support Facilities Design	168,688	
Systems Engineering	833,017	
1.2.3 Detail Design (Title II)		4,710,149
1.2 Engineering Design		7,695,116

University of California

Fluor Daniel, Inc.



Los Alamos National Laboratory
A-E/Partnering Services

Date: 12-12-97
Time: 10:13:30 AM

Project Title: PDCF Facility ROMTPC (Rev.002)
Project Number: PDCFPANTEX (80495-510)

CPDS - CPDS Summary Form

ITEM DESCRIPTION	SUBTOTAL	TOTAL COST
09 C.1 Design Phase Contingencies		9,453,491
09.C.2 Construction Phase Contingencies		
1.1 Project Management		
1.1.2 Project Management Related to Construction		
Construction PM Contingency	3,413,204	
1.1.2 Project Management Related to Construction	3,413,204	
1.1 Project Management	3,413,204	
1.2 Engineering Design		
Inspection (Title III)		
Title III Contingency (Construction Support)	4,036,428	
1.2.4 Inspection (Title III)	4,036,428	
1.2 Engineering Design	4,036,428	
1.4 Construction		
1.4.1 Construction Management & Inspection		
Construction Management Contingency	7,338,960	
1.4.1 Construction Management & Inspection	7,338,960	
1.4.6 Construction Contingency		
Construction Contingency	76,232,251	
1.4.6 Construction Contingency	76,232,251	
1.4 Construction	83,571,211	
09 C.2 Construction Phase Contingencies		91,020,842
Total Project Costs		

University of California

Fluor Daniel, Inc.



Los Alamos National Laboratory
A-E/Partnering Services

Date: 12-12-97
Time: 10:13:30 AM

Project Title: PDCF Facility ROMTPC (Rev.002)
Project Number: PDCFPANTEX (80495-510)

CPDS - CPDS Summary Form

ITEM DESCRIPTION	SUBTOTAL	TOTAL COST
------------------	----------	------------

11.A.2 Other Project Costs

1 Other Project Costs.

1.5.1 Pre-Title I Activities.

Pre-Title I Activities	5,000,000
Pre Title I Activities	2,500,000
Pre Title I Licensing (SAR/Licensing Staff)	5,000,000
Pre Title I Contingency	2,500,000
NEPA Documentation	7,798,000

1.5.1 Pre-Title I Activities	22,798,000
------------------------------	------------

1.5.2 Testing & Startup.

Testing & Startup	61,404,480
Testing & Startup Contingency	27,632,016

1.5.2 Testing & Startup	89,036,496
-------------------------	------------

1.5 Other Project Costs.	111,834,496
--------------------------	-------------

1.7 Decommissioning..

1 Decommissioning Cost

Decommissioning Cost	20,663,668
----------------------	------------

1.7.1 Decommissioning Cost	20,663,668
----------------------------	------------

2 Decommissioning Contingency

Decommissioning Contingency	9,298,650
-----------------------------	-----------

1.7.2 Decommissioning Contingency	9,298,650
-----------------------------------	-----------

1.7 Decommissioning..	29,962,318
-----------------------	------------

3 Research & Development (R&D)

University of California

Fluor Daniel, Inc.



Los Alamos National Laboratory
A-E/Partnering Services

Date: 12-12-97
Time: 10:13:30 AM

Project Title: PDCF Facility ROMTPC (Rev.002)
Project Number: PDCF PANTEX (80495-510)

CPDS - CPDS Summary Form

ITEM DESCRIPTION	SUBTOTAL	TOTAL COST
1.80 R & D		
R & D	104,549,000	
1.80 R & D	104,549,000	
1.8 Research & Development (R&D)	104,549,000	
11 A 2 Other Project Costs		246,345,814
11.B. Related Annual Costs		
1.1.B.1 Facility Operating Costs		
Operations	527,815,053	
1.60 Operations	527,815,053	
1.6 Operations	527,815,053	
11 B 1 Facility Operating Costs		527,815,053
Total Project Costs (TPC)		1,114,194,057



Los Alamos National Laboratory
A-E/Partnering Services

Cost - Project Direct Cost Summary

Date: 12-12-97
Time: 10:18:34 AM

Project Title: PDCF Facility ROMTPC (Rev.002)
Project Number: PDCFPANTEX (80495-510)

Code Value	Description	Quantity	Unit	Manhours	Labor	Materials	Equipment	Subcontract	Indirects & Taxes	Total Cost
1.1	Project Management									
1.1.1	Design Project Management									
1.1.1.1	Organization	3	00YEAR	24,000	2,010,000					2,010,000
1.1.1.2	Staffs	3	00YEAR	750	37,500	75,000				112,500
1.1.1.3	Plans	3	00YEAR	6,000	480,000					480,000
1.1.1.4	Finances	3	00YEAR	6,000	480,000					480,000
1.1.1.5	Directions	3	00YEAR	3,000	150,000					150,000
1.1.1.6	Coordination	3	00YEAR	6,000	300,000					300,000
1.1.1.7	Reports	3	00YEAR	7,500	375,000					375,000
1.1.1.8	Design PM Contingency	3	00YEAR						1,756,375	1,756,375
WorkCode.01.01.PDC3	1.1.1 Design Project Management	24	00YEAR	53,250	3,892,500	75,000			1,756,375	5,665,875
1.1.2	Project Management Related to Construction									
1.1.2.1	Construction PM Contingency	1	00US						7,584,897	7,584,897
		1	00US						3,413,204	3,413,204



Los Alamos National Laboratory
A-E/Partnering Services

Cost - Project Direct Cost Summary

Date: 12-12-97
Time: 10:18:34 AM

Project Title: PDCF Facility ROMTPC (Rev.002)
Project Number: PDCFPA NTEX (80495-510)

Code Value	Description	Quantity	Unit	Manhours	Labor	Materials	Equipment	Subcontract	Indirects & Taxes	Total Cost
WorkCode 01.01.PDC3 1.1.2 Project Management Related to Construction										
		2	00J/S						10,998,100	10,998,100
WorkCode 01.02.PDC2 1.1 Project Management										
		53,250		3,832,500	75,000				12,756,475	18,663,875
1.2 Engineering Design,										
1.2.2 Preliminary Design (Title I),										
2 2 1	A/E Management (Title I)	1	00****	42,531	3,338,082	20,753		54,538	555,786	3,989,157
2 2 2	Facility Design	27	00****	12,032	900,879	28,018		69,056	227,043	1,222,784
2 2 3	Process Design	1	00****	27,850	2,156,148	15,451		51,357	863,368	2,888,321
2 2 4	Mechanical Design	1	00****	15,875	1,125,859	7,913		27,894	350,075	1,511,340
2 2 5	Electrical Design	4	00****	8,290	470,757	3,165		11,078	144,880	628,980
2 2 8	Specifications	1	00****	9,311	718,007	3,840		13,868	255,189	889,134
2 2 7	Systems Engineering	1	00****	23,555	1,125,947	11,138		2,346,381	788,517	4,271,884
WorkCode 01.01.PDC3 1.2.2 Preliminary Design (Title I),										
		36	00****	137,544	8,633,279	86,374		2,574,090	2,984,967	15,480,709
1.2.3 Detail Design (Title II),										



Los Alamos National Laboratory
A-E/Partnering Services

Cost - Project Direct Cost Summary

Date: 12-12-97
Time: 10:18:34 AM

Project Title: PDCF Facility ROMTPC (Rev.002)
Project Number: PDCF/PANTECH (80495-510)

Code Value	Description	Quantity	Unit	Manhours	Labor	Materials	Equipment	Subcontract	Indirects & Taxes	Total Cost
231	A/E Management (Title II)	1 00****		78,460	5,813,802	39,230		137,305	984,710	6,985,147
232	Site Design	1 00****		14,555	1,061,899	7,277		25,471	255,268	1,350,015
233	Process/Building Structural package	1 00****		17,140	1,253,871	8,570		59,895	350,323	1,672,559
234	Process Building Mechanical Internals Package	1 00****		83,997	4,608,727	31,999		111,895	1,428,220	6,178,940
235	Process Building Electrical Internals Package	1 00****		20,400	1,488,188	10,200		35,700	393,383	1,807,449
236	Process Building Architectural	50 00****		7,138	548,059	3,568		12,488	144,224	708,940
237	Procurement Packages (Breakout SFE List)	1 00****		4,710	349,879	2,355		8,243	42,337	402,813
238	Support Facilities Design	1 00****		15,802	1,144,872	7,801		27,304	188,688	1,346,664
239	Systems Engineering	1 00****		41,779	2,340,919	20,890		1,748,873	933,017	5,044,888
	WorkCode.01 01.PDC3 1.2.3 Detail Design (Title II).	58 00****		283,978	18,588,814	131,889		2,168,373	4,710,149	25,597,225
240	Construction Support (Title III)	1 00US			1,501,946	4,536,318	181,731	280,730	2,463,118	8,969,840
247	Title III Contingency (Construction Support)	1 00US							4,038,428	4,038,428



Los Alamos National Laboratory
A-E/Partnering Services

Cost - Project Direct Cost Summary

Date: 12-12-97
Time: 10:18:34 AM

Project Title: PDCF Facility ROMTPC (Rev.002)
Project Number: PDCFPANTEX (80495-510)

Code Value	Description	Quantity	Unit	Manhours	Labor	Materials	Equipment	Subcontract	Indirects & Taxes	Total Cost
	WorkCode.01.01.PDC3 1.2.4 Inspection (Title III)	2	00L/S		1,501,946	4,536,316	181,731	268,730	8,499,546	13,006,288
	WorkCode.01.02.PDC2 1.2 Engineering Design			401,523	29,922,039	4,756,578	181,731	5,029,193	14,194,862	54,084,202
	1.3 Procurement,									
	1.3.0 Procurement,									
300	Procurement	1	00L/S			36,706,000			11,847,788	48,553,788
	WorkCode.01.01.PDC3 1.3.0 Procurement,	1	00L/S			36,706,000			11,847,788	48,553,788
	WorkCode.01.02.PDC2 1.3 Procurement,	1	00L/S			36,706,000			11,847,788	48,553,788
	1.4 Construction,									
	1.4.1 Construction Management & Inspection,									
410	Construction Management & Inspection	1	00L/S					16,308,800		16,308,800
	WorkCode.01.01.PDC3 1.4.1 Construction Management & Inspection,	1	00L/S					16,308,800		16,308,800
411	Construction Management Contingency	2	00L/S						23,847,760	23,847,760
	WorkCode.01.01.PDC3 1.4.1 Construction Management & Inspection,	2	00L/S						23,847,760	23,847,760
	1.4.2 Site Preparation Package,									
420	Site Preparation Package	1	00L/S	85,000	1,398,845	1,870,000	255,000	2,930,000	1,677,893	8,131,738



Los Alamos National Laboratory
A-E/Partnering Services

Cost - Project Direct Cost Summary

Date: 12-12-97
Time: 10:18:34 AM

Project Title: PDCF Facility ROMTPC (Rev.002)
Project Number: PDCF/PANTEX (80495-510)

Code Value	Description	Quantity	Unit	Manhours	Labor	Materials	Equipment	Subcontract	Indirects & Taxes	Total Cost
	WorkCode 01.01.PDC3 1.4.2 Site Preparation Package.	1	100L/S	85,000	1,398,645	1,870,000	255,000	2,930,000	1,877,893	8,131,738
	1.4.4 Process Facility Package.			887,658	22,778,597	32,324,400	2,863,574	2,804,600	15,578,313	76,147,483
4 4 0	Process Facility Package			887,858	22,778,597	32,324,400	2,863,574	2,804,600	15,578,313	76,147,483
	WorkCode 01.01.PDC3 1.4.4 Process Facility Package.	1	100L/S	238,679	5,881,479	19,825,910	718,037		10,388,568	38,771,991
	1.4.5 Support Facilities Package.			238,679	5,881,479	19,825,910	718,037		10,388,568	38,771,991
4 5 0	Support Facilities Package			238,679	5,881,479	19,825,910	718,037		10,388,568	38,771,991
	WorkCode 01.01.PDC3 1.4.5 Support Facilities Package.	1	100L/S	1,211,537	30,038,921	54,020,310	3,634,611	5,734,600	127,502,782	220,831,224
	1.4.6 Construction Contingency			1,211,537	30,038,921	54,020,310	3,634,611	5,734,600	127,502,782	220,831,224
4 6 0	Construction Contingency									
	WorkCode 01.01.PDC3 1.4.6 Construction Contingency	1	100L/S							
	WorkCode 01.02.PDC3 1.4 Construction.	6	00L/S							
	1.5 Other Project Costs.									
	1.5.1 Pre-Title Activities.									



Los Alamos National Laboratory
A-E/Partnering Services

Cost - Project Direct Cost Summary

Date: 12-12-97
Time: 10:18:34 AM

Project Title: PDCF Facility ROMTPC (Rev.002)
Project Number: PDCFPANTEX (80495-510)

Code Value	Description	Quantity	Unit	Manhours	Labor	Materials	Equipment	Subcontract	Indirects & Taxes	Total Cost
5 1 0	Pre-Title I Activities					5,000,000				5,000,000
5 1 1	Pre Title I Activities					2,500,000				2,500,000
5 1 2	Pre Title I Licensing (SAR/Licensing Staff)					5,000,000				5,000,000
5 1 3	Pre Title I Contingency					2,500,000				2,500,000
5 1 4	NEPA Documentation	1.00	U/S					7,798,000		7,798,000
WorkCode 01.01.PDC3 1.5.1 Pre-Title I Activities.										22,798,000
1.5.2 Testing & Startup.										
5 2 0	Testing & Startup			600	58,858,000	4,548,480				61,404,480
5 2 1	Testing & Startup Contingency			270	25,585,200	2,048,816				27,632,016
WorkCode 01.01.PDC3 1.5.2 Testing & Startup.										89,038,496
WorkCode 01.02.PDC2 1.5 Other Project Costs.										
1.6 Operations.				870	82,441,200	21,595,296		7,798,000		111,834,496
1.6.0 Operations.										

Cost - Project Direct Cost Summary

Date: 12-12-97
 Time: 10:18:34 AM

Project Title: PDCF Facility ROMTPC (Rev.002)
 Project Number: PDCFANTEX (80495-510)

Code Value	Description	Quantity	Unit	Manhours	Labor	Materials	Equipment	Subcontract	Indirects & Taxes	Total Cost
8 0 0	Operations			8,318,029	386,906,017	120,950,740	954,086	2,403,083	16,601,128	527,815,053
	WorkCode 01.01.PDC3 1.8.0 Operations.			8,318,029	386,906,017	120,950,740	954,086	2,403,083	16,601,128	527,815,053
	WorkCode 01.02.PDC2 1.8 Operations..			8,318,029	386,906,017	120,950,740	954,086	2,403,083	16,601,128	527,815,053
	1.7 Decommissioning..									
	1.7.1 Decommissioning Cost									
7 1 0	Decommissioning Cost	1	100L/S	127,211	3,154,087	9,526,263	381,634	961,233	6,640,451	20,663,668
	WorkCode 01.01.PDC3 1.7.1 Decommissioning Cost	1	100L/S	127,211	3,154,087	9,526,263	381,634	961,233	6,640,451	20,663,668
	1.7.2 Decommissioning Contingency									
7 2 0	Decommissioning Contingency	1	100L/S	57,245	1,419,339	4,286,818	171,735	432,555	2,888,203	9,298,650
	WorkCode 01.01.PDC3 1.7.2 Decommissioning Contingency	1	100L/S	57,245	1,419,339	4,286,818	171,735	432,555	2,888,203	9,298,650
	1.8 Research & Development (R&D)									
8 0 0	R & D	2	200L/S	184,457	4,573,426	13,813,081	553,370	1,393,786	9,628,654	29,962,318
	WorkCode 01.02.PDC2 1.7 Decommissioning..	2	200L/S	184,457	4,573,426	13,813,081	553,370	1,393,786	9,628,654	29,962,318
	1.8.0 R & D									
	WorkCode 01.01.PDC3 1.8.0 R & D									
	104,549,000									



Los Alamos National Laboratory
A-E/Partnering Services

Cost - Project Direct Cost Summary

Date: 12-12-97
Time: 10:18:34 AM

Project Title: PDCF Facility ROMTPC (Rev.002)
Project Number: PDCFPANTEX (80495-510)

Code Value	Description	Quantity	Unit	Manhours	Labor	Materials	Equipment	Subcontract	Indirects & Taxes	Total Cost
WorkCode.01.01.PDC3	1.8.0 R & D	1	100LS					104,549,000		104,549,000
WorkCode 01.02.PDC2	1.8 Research & Development (R&D)	1	100LS					104,549,000		104,549,000
Grand Total				10,169,665	537,714,102	251,917,006	5,323,797	128,907,863	192,331,490	1,114,194,057



Los Alamos National Laboratory
A-E/Partnering Services

Cost - Project Direct Cost Summary

Date: 12-12-97
Time: 10:15:27 AM

Project Title: PDCF Facility ROMTPC (Rev.002)
Project Number: PDCFANTEX (80495-510)

Code Value	Description	Quantity	Unit	Manhours	Labor	Materials	Equipment	Subcontract	Indirects & Taxes	Total Cost
1.1.1	Design Project Management									
1.1.1.1	Organization									
A01	Organization	3	00YEAR	24,000	2,010,000					2,010,000
WorkCode.01.00.PCD4	1.1.1.1 Organization									
1.1.1.2	Staffs									
A05	Staffs	3	00YEAR	750	37,500	75,000				112,500
WorkCode.01.00.PCD4	1.1.1.2 Staffs									
1.1.1.3	Plans									
A10	Plans	3	00YEAR	750	37,500	75,000				112,500
WorkCode.01.00.PCD4	1.1.1.3 Plans									
1.1.1.4	Finances									
A10	Finances	3	00YEAR	6,000	480,000					480,000
WorkCode.01.00.PCD4	1.1.1.4 Finances									
1.1.1.5	Directions									
A15	Directions	3	00YEAR	6,000	480,000					480,000
WorkCode.01.00.PCD4	1.1.1.5 Directions									



Los Alamos National Laboratory
A-E/Partnering Services

Cost - Project Direct Cost Summary

Date: 12-12-97
Time: 10:15:27 AM

Project Title: PDCF Facility ROMTPC (Rev.002)
Project Number: PDCFPA NTEX (80495-510)

Code Value	Description	Quantity	Unit	Manhours	Labor	Materials	Equipment	Subcontract	Indirects & Taxes	Total Cost
120	Directions	3.00	YEAR	3,000	150,000					150,000
	WorkCode.01.00.PCD4 1.1.1.5 Directions	3.00	YEAR	3,000	150,000					150,000
	1.1.1.6 Coordination									
125	Coordination	3.00	YEAR	6,000	300,000					300,000
	WorkCode.01.00.PCD4 1.1.1.8 Coordination	3.00	YEAR	6,000	300,000					300,000
	1.1.1.7 Reports									
130	Reports	3.00	YEAR	7,500	375,000					375,000
	WorkCode.01.00.PCD4 1.1.1.7 Reports	3.00	YEAR	7,500	375,000					375,000
	1.1.1.8 Design PM Contingency									
101	Organization								904,500	904,500
105	Staffs								50,625	50,625
110	Plans								216,000	216,000
115	Finances								216,000	216,000



Los Alamos National Laboratory
A-E/Partnering Services

Cost - Project Direct Cost Summary

Date: 12-12-97
Time: 10:15:27 AM

Project Title: PDCF Facility ROMTPC (Rev.002)
Project Number: PDCFPA NTEX (80495-510)

Code Value	Description	Quantity	Unit	Manhours	Labor	Materials	Equipment	Subcontract	Indirects & Taxes	Total Cost
120	Directions	3	00YEAR						67,500	67,500
125	Coordination	3	00YEAR						135,000	135,000
130	Reports	3	00YEAR						168,750	168,750
									1,758,375	1,758,375
	WorkCode 01.00.PCD4 1.1.1.8 Design PM Contingency	21	00YEAR						1,758,375	1,758,375
	WorkCode 01.01.PDC3 1.1 Design Project Management	42	00YEAR	53,250	3,832,500	75,000			1,758,375	5,865,875
	1.1.2 Project Management Related to Construction									
	1.1.2.0 Project Management Related to Construction									
F144	Process Facility Package	1	00L/S						3,528,143	3,528,143
T001	Procurement	1	00L/S						2,154,380	2,154,380
F145	Site Work Package	1	00L/S						351,881	351,881
F142	Support Facilities Package	1	00L/S						1,549,893	1,549,893
									7,584,897	7,584,897
	WorkCode 01.00.PCD4 1.1.2.0 Project Management Related to Construction	4	00L/S						7,584,897	7,584,897
	1.1.2.1 Construction PM Contingency									



Los Alamos National Laboratory
A-E/Partnering Services

Cost - Project Direct Cost Summary

Date: 12-12-97
Time: 10:15:27 AM

Project Title: PDCF Facility ROMTPC (Rev.002)
Project Number: PDCFPANTEX (80495-510)

Code Value	Description	Quantity	Unit	Manhours	Labor	Materials	Equipment	Subcontract	Indirects & Taxes	Total Cost
F144	Process Facility Package	1	00L/S						1,588,114	1,588,114
T001	Procurement	1	00L/S						969,471	969,471
F145	Site Work Package	1	00L/S						158,257	158,257
P142	Support Facilities Package	1	00L/S						697,382	697,382
		4	00L/S						3,413,204	3,413,204
	WorkCode.01.00.PCD4 1.1.2.1 Construction PM Contingency									
		8	00L/S						10,998,100	10,998,100
	WorkCode.01.01.PDC3 1.1.2 Project Management Related to Construction									
	1.2.2 Preliminary Design (Title I)									
	1.2.2.1 A/E Management (Title I)									
E05	A/E Task Management	1	00L/S	15,500	1,288,045	7,300		7,300		1,302,645
E10	Task Administration	1	00L/S	11,825	731,487	5,913		20,694		758,093
E15	Technical Process/Reviews	1	00L/S	2,160	188,431	1,080		3,780		191,291
E20	Finance Management	1	00L/S	360	27,412	180		630		28,222
E25	Interface/Coordination Management	1	00L/S	3,650	396,354	1,825		6,388		404,607

Cost - Project Direct Cost Summary

Date: 12-12-97
 Time: 10:15:27 AM

Project Title: PDCF Facility ROMTPC (Rev.002)
 Project Number: PDCFPANTEX (80495-510)

Code Value	Description	Quantity	Unit	Manhours	Labor	Materials	Equipment	Subcontract	Indirects & Taxes	Total Cost
E30	Performance Measurement	1	00L/S	4,250	290,015	2,125		7,438		299,578
E35	Requirements & Standards	1	00L/S	1,600	152,593	800		2,800		156,193
E40	Configuration Management	1	00L/S	2,725	231,493	1,350		4,786		237,831
E45	Detail Design Estimate for Title II Baseline	1	00DOC	461	34,212	180		720		35,112
XXX	Applications - Design Contingency WBS Level 4	1	00L/S						555,788	555,788
WorkCode 01.00.PCD4 1.2.2.1 A/E Management (Title I)		42,531		3,338,082	20,753		54,536			3,986,157
1.2.2.2 Facility Design										
D05	Site Development Design	27	00DWG	1,709	123,508	855		32,991		157,353
D10	Process Facility General Arrangements	31	00DWG	1,645	144,843	923		3,229		148,994
D15	Support Facility General Arrangements	14	00DWG	480	40,413	240		840		41,493
D20	Electrical Primary Distribution Drawings	13	00DWG	1,170	79,859	585		2,048		82,492
D25	Communication System Drawings	3	00DWG	180	11,733	90		315		12,138
D30	Fire Detection / Protection Drawings	2	00DWG	90	8,957	45		158		7,159
D35	Safeguards & Security System Drawings	12	00DWG	768	59,140	384		1,344		60,868



Los Alamos National Laboratory
A-E/Partnering Services

Cost - Project Direct Cost Summary

Date: 12-12-97
Time: 10:15:27 AM

Project Title: PDCF Facility ROMTPC (Rev.002)
Project Number: PDCFPANTEX (80495-510)

Code Value	Description	Quantity	Unit	Manhours	Labor	Materials	Equipment	Subcontract	Indirects & Taxes	Total Cost
D40	Geotechnical Investigation Support	1	00LJS	170	15,825	85		298		16,207
D45	Building Structural Analysis	1	00LJS	2,290	170,004	21,145		22,008		213,158
D46	General Structural Engineering & Drawings	56	00DWWG	1,930	136,712	965		3,378		141,054
D48	Structural Engineering Design Basis Document	1	00DOC	160	12,865	80		280		13,225
D50	Preliminary Shielding/Criticality & Analysis	1	00LJS	1,240	98,822	820		2,170		101,812
XXX	Applications - Design Contingency WBS Level 4	1	00LJS						227,043	227,043
WorkCode:01.00.PCDA 1.2.2.2 Facility Design		12,032			900,679	26,016		69,056	227,043	1,222,784
1.2.2.3 Process Design										
D47	Seismic Qualifications & Equipment	1	00LJS	460	35,893	240		840		38,973
R07	Process Flow Diagrams PFD's	37	00DWWG	6,055	452,514	3,095		10,833		468,441
R10	Piping & Instrumentation Diagram, P&ID's	37	00DWWG	10,379	772,945	8,428		19,401		798,773
R15	Utility Load Lists	8	00DWWG	80	6,692	400		1,400		8,492
R20	System Design Descriptions	37	00EA	10,876	888,104	5,288		18,883		912,275



Los Alamos National Laboratory
A-E/Partnering Services

Cost - Project Direct Cost Summary

Date: 12-12-97
Time: 10:15:27 AM

Project Title: PDCF Facility ROMTPC (Rev.002)
Project Number: PDCFPANTEX (80495-510)

Code Value	Description	Quantity	Unit	Manhours	Labor	Materials	Equipment	Subcontract	Indirects & Taxes	Total Cost
xxx	Applications - Design Contingency WBS Level 4	1	00LJS						663,368	663,368
	WorkCode 01 00.PCD4 1.2.2.3 Process Design			27,850	2,156,148	15,451		51,357	663,368	2,888,321
	1.2.4 Mechanical Design									
R21	Mechanical Design Basis Document	1	00DOC	180	13,384	90		315		13,789
R25	Material Handling Drawings	3	00DWG	390	27,220	195		663		28,067
R30	Equipment Layouts	30	00DWG	1,260	64,804	555		1,843		67,301
R35	HVAC Zone Drawings	4	00DWG	280	18,028	130		455		18,613
R37	Miscellaneous HVAC Activities	1	00LOT	640	47,414	320		1,120		48,854
R40	HVAC Flow and Control Drawings	51	00DWG	7,580	551,750	3,790		13,265		568,805
R45	Piping Drawings - Utilities/Services	44	00DWG	4,865	327,828	2,433		8,514		338,574
R55	Piping Drawings Fire Protections	1	00DWG	70	5,202	35		123		5,359
R60	Equipment List	1	00LIST	730	50,230	365		1,278		51,873
xxx	Applications - Design Contingency WBS Level 4	1	00LJS						350,075	350,075



Los Alamos National Laboratory
A-E/Partnering Services

Cost - Project Direct Cost Summary

Date: 12-12-97
Time: 10:15:27 AM

Project Title: PDCF Facility ROMTPC (Rev.002)
Project Number: PDCFANTEX (80495-510)

Code Value	Description	Quantity	Unit	Manhours	Labor	Materials	Equipment	Subcontract	Indirects & Taxes	Total Cost
[Redacted]										
[Redacted]										
[Redacted]										
1.2.2.5 Electrical Design										
		15,975		1,125,659	7,913			27,694	350,075	1,511,340
[Redacted]										
	Electrical Single Line	4	000DWG	840	81,388	420		1,470		83,278
	Electrical Load List	1	00SPEC	400	29,477	200		700		30,377
	DCS Development	5	00SPEC	740	57,252	370		1,285		58,917
	DCS Drawings	10	000DWG	700	54,157	350		1,225		55,732
	HPS Development	5	00SPEC	500	38,818	270		945		39,833
	HPS Drawings	10	000DWG	540	41,788	270		945		42,863
	Fire Detection/Protection - Electrical Drawgs	3	000DWG	330	23,703	165		578		24,445
	Electrical Outline Specs	1	00SPEC	2,240	164,394	1,120		3,820		169,434
	Applications - Design Contingency WBS Level 4	1	00L/S						144,980	144,980
[Redacted]										
[Redacted]										
	Specifications	6,290		470,757	3,185			11,078	144,980	629,980



Los Alamos National Laboratory
A-E/Partnering Services

Cost - Project Direct Cost Summary

Date: 12-12-97
Time: 10:15:27 AM

Project Title: PDCF Facility ROMTFC (Rev.002)
Project Number: PDCFPANTEX (80495-510)

Code Value	Description	Quantity	Unit	Manhours	Labor	Materials	Equipment	Subcontract	Indirects & Taxes	Total Cost
SP05	Plant Equipment Outline Specifications	1	00SPEC	247	20,710	124		432		21,286
SP10	Process Equipment Outline Specifications	42	00SPEC	1,420	107,120	630		2,405		110,155
SP11	Piping Line Class Specifications	2	00SPEC	300	24,018	150		525		24,693
SP11B	Process Equipment Data Sheets	171	00EA	4,874	368,965	1,881		6,584		377,429
SP15	Structural/Civil Outline Specifications		US	330	28,500	185		578		29,242
SP20	Fire Protection Outline Specifications	2	00SPEC	40	3,378	20		70		3,468
SP25	Physical Security Outline Specifications	1	00SPEC	240	20,254	40		140		20,434
SP40	Prepare Summary Load Analysis	1	00SPEC	360	28,784	180		630		27,594
SP45	Control Console Details/Layout	3	00DWG	640	49,538	320		1,120		50,978
SP46	General Engineering: Calcs/Prepare UPS Loads	6	00SPEC	880	68,744	430		1,505		68,679
XXXX	Applications - Design Contingency WBS Level 4	1	00US						255,189	255,189
WorkCode 01.00.PCD4 1.2.2.6 Specifications				9,311	716,007	3,940		13,988	255,189	989,134
1.2.2.7 Systems Engineering										

Los Alamos National Laboratory
 A-E/Partnering Services

Cost - Project Direct Cost Summary

Date: 12-12-97
 Time: 10:15:27 AM

Project Title: PDCF Facility ROMTPC (Rev.002)
 Project Number: PDCFANTEX (80495-510)

Code Value	Description	Quantity	Unit	Manhours	Labor	Materials	Equipment	Subcontract	Indirects & Taxes	Total Cost
E48	Special Studies	1	00L/S					870,000		870,000
P29	Vulnerability Assessment	1	00EA	40	3,378	20		40,070		43,468
R04	Value Engineering Process and Report	1	00L/S	1,180	98,514	590		2,065		99,169
R05	Project Design Guide/Std/Require ID Docmnt	1	00DOC	2,040	171,428	1,020		3,570		176,018
R10	RAMI / FMECA	1	00DOC	2,000	159,390	400		1,400		161,190
R15	Interface Control Documents/Drawings	1	00L/S	2,240	189,069	1,120		3,920		184,109
R25	DB Prel Fire Analysis, Fire Hazards Analysis	1	00SPEC	240	20,254	120		420		20,794
R28	Process Discipline Design Basis Doc.	1	00L/S	120	9,680	60		210		9,950
R27	Life Safety Review of Floor Plan	1	00EA	80	6,751	40		140		6,931
R30	Preliminary Design Report	1	00DOC	3,095	257,516	1,508		5,378		264,400
R35	PSAR Support	1	00DOC	10,120	178,038	5,060		1,135,550		1,318,648
R40	Preliminary Hazards Analysis Support	1	00DOC	2,400	33,931	1,200		283,680		318,791
XXX	Applications - Design Contingency WBS Level 4	1	00L/S						788,517	788,517
				23,555	1,125,947	11,138		2,348,381	788,517	4,271,984

WorkCode 01 00 PCD4 1 2 2 7 Systems Engineering

ESTIMATOR (TM)

Los Alamos National Laboratory
 A-E/Partnering Services

Cost - Project Direct Cost Summary

Date: 12-12-97
 Time: 10:15:27 AM

Project Title: PDCF Facility ROMTPC (Rev.002)
 Project Number: PDCFPANTEX (80495-510)

Code Value	Description	Quantity	Unit	Manhours	Labor	Materials	Equipment	Subcontract	Indirects & Taxes	Total Cost
	WorkCode.01.01.PDC3 1.2.2 Preliminary Design (Title I).			137,544	9,833,279	88,374		2,574,090	2,984,967	15,480,709
	1.2.3 Detail Design (Title II).									
	1.2.3.1 A/E Management (Title II)									
122AE05	A/E Task Management - Title II Year 2	1.00	US	10,025	738,230	5,013		17,544		758,787
122AE10	Task Administration Title II Year 2	1.00	US	11,825	708,278	5,813		20,884		732,885
122AE15	Technical Process/Reviews Title II Year 2	1.00	US	4,320	372,862	2,160		7,560		382,582
122AE20	Finance Management Title II Year 2	1.00	US	360	27,412	180		630		28,222
122AE25	Interface/Coordination Mgt Title II Year 2	1.00	US	2,850	309,513	1,425		4,888		315,928
122AE30	Performance Measurement Title II Year 2	1.00	US	3,325	220,802	1,683		5,819		228,283
122AE35	Requirements & Standards Title II Year 2	1.00	US	700	65,436	350		1,225		67,011
122AE40	Engineering Change Controls Title II Year 2	1.00	US	1,200	130,321	600		2,100		133,021
122AE45	Detailed Design Estimate for IGE	1.00	DOC	8,600	515,433	3,400		11,900		530,733
122AE05	A/E Task Management - Title II Year 1	1.00	US	10,025	736,230	5,013		17,544		758,787

Cost - Project Direct Cost Summary

Date: 12-12-97
Time: 10:15:27 AM

Project Title: PDCF Facility ROMTPC (Rev.002)
Project Number: PDCFPA NTEX (80495-510)

Code Value	Description	Quantity	Unit	Manhours	Labor	Materials	Equipment	Subcontract	Indirects & Taxes	Total Cost
2AE10	Task Administration - Title II Year 1	1	00LJS	11,825	706,278	5,913		20,894		732,885
2AE15	Technical Process/Reviews - Title II Year 1	1	00LJS	3,520	303,135	1,760		6,160		311,055
2AE20	Finance Management - Title II Year 1	1	00LJS	360	27,412	180		630		28,222
2AE25	Interface/Coordination Management - Year 1	1	00LJS	3,750	334,865	1,875		6,563		343,303
2AE30	Performance Measurement - Title II Year 1	1	00LJS	4,550	298,466	2,275		7,963		308,704
2AE35	Requirements & Standards - Title II Year 1	1	00LJS	400	38,148	200		700		39,048
2AE40	Engineering Change Controls - Title II Year	1	00LJS	2,625	285,078	1,313		4,594		290,984
XXX	Applications - Design Contingency WBS Level 4	1	00LJS					994,710		994,710
WorkCode 01 00.PCD4 1.2.3.1 AE Management (Title II)		78,460		5,813,902	39,230	137,305		994,710		6,985,147
1.2.3.2 Site Design										
2S05	Civil Design Basis Document	1	00DOC	500	40,911	250		875		42,036
2S10	Site Utilities Package	47	00DWG	6,395	449,215	3,198		11,191		463,604
2S15	Site Preparation Drawings	28	00DWG	3,050	220,438	1,525		5,338		227,298
2S20	Security Fence & Security Lighting Drawings	11	00DWG	1,130	79,404	565		1,978		81,946



Los Alamos National Laboratory
A-E/Partnering Services

Cost - Project Direct Cost Summary

Date: 12-12-97
Time: 10:15:27 AM

Project Title: PDCF Facility ROMTPC (Rev.002)
Project Number: PDCFPANTEX (80495-510)

Code Value	Description	Quantity	Unit	Manhours	Labor	Materials	Equipment	Subcontract	Indirects & Taxes	Total Cost
2S25	Final Site Work	19 000	DWG	2,460	164,232	1,230		4,305		189,767
2S30	Construction Facilities	2 000	DWG	300	21,677	150		525		22,352
2S35	Detailed Civil Specs	1 000	L/S	480	44,083	240		840		45,163
2S55	Office & Warehouse Buildings	1 000	L/S	80	7,347	40		140		7,527
2S60	Shop Fab/Support Facility - Layout	1 000	L/S	80	7,347	40		140		7,527
2S65	Laydown & Secure Areas, Entry Control	1 000	L/S	60	7,347	40		140		7,527
XXX	Applications - Design Contingency WBS Level 4								255,268	255,268
WorkCode.01.00.PC04 1.2.3.2 Site Design		14,555			1,061,999	7,277		25,471	255,268	1,350,015
1.2.3.3 Process/Building Structural package										
2SP05	Structural Design Basis Document	1 000	DOC	300	23,862	150		525		24,537
2SP10	Bldg Structural Analysis	1 000	DOC	2,120	157,991	1,060		33,710		192,761
2SP15	Bldg Structural Drawings/Sections/Details	94 000	DWG	8,780	621,933	4,390		15,365		641,688
2SP20	Seismic Design & Quas of Systems & Component	1 000	L/S	5,640	426,851	2,820		9,870		439,541



Los Alamos National Laboratory
A-E/Partnering Services

Cost - Project Direct Cost Summary

Date: 12-12-97
Time: 10:15:27 AM

Project Title: PDCF Facility ROMTPC (Rev.002)
Project Number: PDCF/PANTEX (80495-510)

Code Value	Description	Quantity	Unit	Manhours	Labor	Materials	Equipment	Subcontract	Indirects & Taxes	Total Cost
2SP25	Detailed Structural Specifications	9.00	SPEC	300	23,033	150		525		23,708
XXX	Applications - Design Contingency WBS Level 4	1.00	US						350,323	350,323
	WorkCode:01.00.PCD4 1.2.3.3 Process/Building Structural package			17,140	1,253,671	8,570		59,995	350,323	1,672,559
	1.2.3.4 Process Building Mechanical Internals Package									
2M05	Mechanical Design Basis Document	1.00	DOC	580	43,678	290		1,015		44,981
2M10	Material Handling	105.00	DWG	12,150	856,784	6,075		21,263		864,121
2M15	Mechanical Piping	315.00	DWG	20,370	1,376,578	10,185		35,646		1,424,410
2M20	HVAC	98.00	DWG	24,040	1,752,610	12,020		42,070		1,806,800
2M25	HVAC Design Basis Document	1.00	DOC	340	29,569	170		595		30,334
2M30	HVAC Flow Diagram	85.00	US	1,260	95,913	630		2,205		88,748
2M35A	Fire Detection/Protection/Alarms	7.00	DWG	1,360	109,663	680		2,360		112,723
2M40	Detailed Mechanical Specifications	45.00	SPEC	3,897	339,735	1,949		6,820		346,503
XXX	Applications - Design Contingency WBS Level 4	1.00	US						1,428,220	1,428,220

University of California
Fluor Daniel, Inc.



Los Alamos National Laboratory
 A-E/Partnering Services

Cost - Project Direct Cost Summary

Date: 12-12-97
 Time: 10:15:27 AM

Project Title: PDCF Facility ROMTPC (Rev.002)
 Project Number: PDCFANTEX (80495-510)

Code Value	Description	Quantity	Unit	Manhours	Labor	Materials	Equipment	Subcontract	Indirects & Taxes	Total Cost
<p>WorkCode:01.00 PCDA 1.2.3.4 Process Building Mechanical Internals Package</p> <p>1.2.3.5 Process Building Electrical Internals Package</p>										
2E05	Electrical Design Basis Document	1.00	DOC	240	17,856	120		420		16,396
2E10	Electrical Safeguards & Security Systems	3.00	DWG	120	8,928	60		210		9,198
2E15	Electrical Single Line	4.00	DWG	480	36,045	240		840		37,125
2E20	Power Plan	14.00	DWG	1,600	113,078	800		2,800		116,678
2E21	DCS Package	60.00	DWG	7,200	506,212	3,600		12,600		522,412
2E22	Control Console	14.00	DWG	1,800	130,181	900		3,150		134,231
2E23	HPS Package	6.00	DWG	720	51,279	360		1,260		52,899
2E24	MIS Design	8.00	DWG	720	50,750	360		1,260		52,370
2E25	Lightning Plan - Interior	8.00	DWG	760	54,714	390		1,365		56,469
2E30	Grounding plan - Interior	4.00	DWG	480	35,078	240		640		36,156
2E35	Lightning Protection Plan	2.00	DWG	240	16,750	120		420		17,290
<p>63,997 4,606,727 31,999 111,995 1,428,220 6,178,940</p>										

Cost - Project Direct Cost Summary

Date: 12-12-97
Time: 10:15:27 AM

Project Title: PDCF Facility ROMTPC (Rev.002)
Project Number: PDCF/PANTEX (80495-510)

Code Value	Description	Quantity	Unit	Manhours	Labor	Materials	Equipment	Subcontract	Indirects & Taxes	Total Cost
T2E40	Elementary Diagram	2	00DWG	240	17,856	120		420		18,396
T2E45	Communications - Electrical Details	2	00DWG	240	16,348	120		420		16,888
T2E50	Load List & Summary Analysis	6	00DWG	720	53,567	360		1,260		55,187
T2E55	I & C Design Basis Document	1	00DOC	260	20,160	130		455		20,745
T2E60	Computer Systems Design	6	00DWG	720	51,386	360		1,260		53,008
T2E70	Electrical Specifications	32	00DOC	3,640	288,002	1,920		6,720		286,642
XXXX	Applications - Design Contingency WBS Level 4	1	00L/S						393,363	393,363
WorkCode.01.00 PCD4 1.2.3.5 Process Building Electrical Internals Package				20,400	1,468,186	10,200		35,700	393,363	1,907,449
1.2.3.6 Process Building Architectural										
T2A05	Building General Arrangements	50	00DWG	2,680	205,332	1,340		4,690		211,362
T2A10	Title II Architectural Drawings	67	00DWG	3,616	276,969	1,808		6,328		285,105
T2A20	Detailed Architectural Specifications	41	00DWG	840	64,358	420		1,470		66,248
XXXX	Applications - Design Contingency WBS Level 4	1	00L/S						144,224	144,224

Cost - Project Direct Cost Summary

Date: 12-12-97
 Time: 10:15:27 AM

Project Title: PDCF Facility ROMTPC (Rev.002)
 Project Number: PDCFPANTEX (80495-510)

Code Value	Description	Quantity	Unit	Manhours	Labor	Materials	Equipment	Subcontract	Indirects & Taxes	Total Cost
1.2.3.6 Process Building Architectural										
WorkCode 01.00.PCD4	1.2.3.6 Process Building Architectural			7,136	546,659	3,588		12,488	144,224	708,940
1.2.3.7 Procurement Packages (Breakout SFE List)										
2P05	Gloveboxes	1	00LJS	690	51,591	345		1,208		53,143
2P10	Process Equipment	30	00DWG	3,800	285,209	1,800		8,500		273,309
2P15	Facility Equipment	1	00EA	420	33,080	210		735		34,025
XXX	Applications - Design Contingency WBS Level 4	1	00LJS						42,337	42,337
1.2.3.8 Support Facilities Design										
WorkCode 01.00.PCD4	1.2.3.7 Procurement Packages (Breakout SFE List)			4,710	349,879	2,355		8,243	42,337	402,813
2AF05 Support Building General Arrangements										
2AF05	Support Building General Arrangements	1	00DWG	60	4,587	30		105		4,732
2AF10 Support Building Title II Drawings										
2AF10	Support Building Title II Drawings	94	00DWG	5,410	414,308	2,705		9,488		428,478
2AF15 Support Building Calculations/Special										
2AF15	Support Building Calculations/Special	10	00DWG	272	20,840	138		478		21,452
2S52 Generators										
2S52	Generators	40	00DWG	2,370	170,853	1,185		4,148		178,185
2SF10 Waste Storage										
2SF10	Waste Storage	4	00DWG	440	30,041	220		770		31,031



Los Alamos National Laboratory
A-E/Partnering Services

Cost - Project Direct Cost Summary

Date: 12-12-97
Time: 10:15:27 AM

Project Title: PDCF Facility ROMTPC (Rev.002)
Project Number: PDCFANTEX (80495-510)

Code Value	Description	Quantity	Unit	Manhours	Labor	Materials	Equipment	Subcontract	Indirects & Taxes	Total Cost
'SF15	Utility Building	8.00	DWG	1,020	68,644	510		1,785		70,939
'SF20	Source Calibration Facility	32.00	DWG	2,760	199,899	1,380		4,630		208,109
'SF30	Unit Substation (2)	3.00	DWG	300	21,251	150		525		21,926
'SF45	Effluent Monitoring System, 4 Met. Towers	1.00	DWG	100	7,064	50		175		7,309
'SF50	Fire Water Storage Pumphouse	8.00	DWG	1,040	69,408	520		1,820		71,748
'SF55	Cooling Water Tower	9.00	DWG	1,040	71,224	520		1,820		73,564
'SF60	Diesel Fuel Storage	5.00	DWG	590	39,484	295		1,033		40,812
'SF65	Liquidified Gas Supply	2.00	DWG	200	13,622	100		350		14,072
'SF70	Compressed Gas Storage	2.00	DWG	200	13,622					13,822
XXX	Applications - Design Contingency WBS Level 4	1.00	L/S						168,688	168,688
WorkCode.01.00.PCD4 1.2.3.8 Support Facilities Design		15,602			1,144,872	7,801		27,304	168,688	1,346,664
1.2.3.9 Systems Engineering		1.440			119,262	720		2,520		122,502
'SE05	Project Design Guide/Side/Require ID Docmnt	1.00	DOC							

Cost - Project Direct Cost Summary

Date: 12-12-97
 Time: 10:15:27 AM

Project Title: PDCF Facility ROMTPC (Rev.002)
 Project Number: PDCFANTEX (80495-510)

Code Value	Description	Quantity	Unit	Manhours	Labor	Materials	Equipment	Subcontract	Indirects & Taxes	Total Cost
r2SE10	RAMI	1.00	DOC	400	31,878	200		700		32,778
r2SE15	Human Factors	1.00	U/S	320	24,758	160		560		25,478
r2SE20	Configuration Management	1.00	U/S	4,000	297,693	2,000		7,000		306,693
r2SE25	Detailed Design Report	37.00	EA	1,480	112,189	740		2,590		115,529
r2SE30	Failure Mode Effects Analysis	1.00	U/S	1,000	77,698	500		1,750		79,948
r2SE35	ALARA Analysis	1.00	DOC	2,000	156,733	1,000		3,500		161,233
r2SE60	Regulatory Compliance	1.00	U/S	14,800	243,460	7,450		1,702,835		1,953,745
r2SE65	System Design Descriptions	37.00	EA	18,239	1,277,240	8,120		28,418		1,313,778
XXXX	Applications - Design Contingency WBS Level 4	1.00	U/S						933,017	933,017
WorkCode 01.00.PCD4 1.2.3.9 Systems Engineering				41,779	2,340,919	20,890		1,749,873	933,017	5,044,698
WorkCode 01.01.PDC3 1.2.3 Detail Design (Title II)				263,979	18,566,814	131,889		2,168,373	4,710,149	25,597,225
1.2.4 Inspection (Title III)										
1.2.4.0 Construction Support (Title III)										



Los Alamos National Laboratory
A-E/Partnering Services

Cost - Project Direct Cost Summary

Date: 12-12-97
Time: 10:15:27 AM

Project Title: PDCF Facility ROMTPC (Rev.002)
Project Number: PDCFPANTEX (80495-510)

Code Value	Description	Quantity	Unit	Manhours	Labor	Materials	Equipment	Subcontract	Indirects & Taxes	Total Cost
F144	Process Facility Package	1	00U/S	1,138,930	1,616,220	133,179	140,230	1,144,978	4,173,537	
T001	Procurement	1	00U/S	1,835,300	712,453				2,547,753	
F145	Site Work Package	1	00U/S	69,942	93,500	12,750	148,500	83,203	415,898	
P142	Support Facilities Package	1	00U/S	293,074	991,298	35,802		512,483	1,832,655	
<div style="border: 1px solid black; padding: 2px;"> WorkCode.01.00.PCD4 1.2.4.0 Construction Support (Title III) </div>										
<div style="border: 1px solid black; padding: 2px;"> 1.2.4.7 Title III Contingency (Construction Support) </div>										
F144	Process Facility Package	1	00U/S	1,501,946	4,536,316	161,731	288,730	2,463,116	8,969,840	
T001	Procurement	1	00U/S		1,878,091				1,878,091	
F145	Site Work Package	1	00U/S		1,146,469				1,146,469	
P142	Support Facilities Package	1	00U/S		187,153				187,153	
<div style="border: 1px solid black; padding: 2px;"> WorkCode.01.00.PCD4 1.2.4.7 Title III Contingency (Construction Support) </div>										
<div style="border: 1px solid black; padding: 2px;"> 4,036,428 </div>										
<div style="border: 1px solid black; padding: 2px;"> WorkCode.01.01.PDC3 1.2.4. Inspection (Title III) </div>										
<div style="border: 1px solid black; padding: 2px;"> 1.3.0 Procurement, </div>										
		8	00U/S	1,501,946	4,536,316	161,731	288,730	6,499,546	13,006,268	



Los Alamos National Laboratory
A-E/Partnering Services

Cost - Project Direct Cost Summary

Date: 12-12-97
Time: 10:15:27 AM

Project Title: PDCF Facility ROMTPC (Rev.002)
Project Number: PDCFPANTEX (80495-510)

Code Value	Description	Quantity	Unit	Manhours	Labor	Materials	Equipment	Subcontract	Indirects & Taxes	Total Cost
1.3.0.0	Procurement									
T001	Procurement	1	00U/S			36,706,000			11,647,788	48,353,788
WorkCode 01.00.PCD4	1.3.0.0 Procurement	1	00U/S			36,706,000			11,647,788	48,353,788
WorkCode 01.01.PDC3	1.3.0 Procurement	1	00U/S			36,706,000			11,647,788	48,353,788
1.4.1	Construction Management & Inspection									
1.4.1.0	Construction Management & Inspection									
F144	Process Facility Package	1	00U/S						7,588,248	7,588,248
T001	Procurement	1	00U/S						4,632,279	4,632,279
F145	Site Work Package	1	00U/S						758,174	758,174
P142	Support Facilities Package	1	00U/S						3,332,099	3,332,099
WorkCode 01.00.PCD4	1.4.1.0 Construction Management & Inspection	4	00U/S						16,308,800	16,308,800
1.4.1.1	Construction Management Contingency									
F144	Process Facility Package	1	00U/S						3,414,712	3,414,712
T001	Procurement	1	00U/S						2,084,525	2,084,525

Los Alamos National Laboratory
 A-E/Partnering Services

Cost - Project Direct Cost Summary

Date: 12-12-97
 Time: 10:15:27 AM

Project Title: PDCF Facility ROMTPC (Rev.002)
 Project Number: PDCF/PANTEX (80495-510)

Code Value	Description	Quantity	Unit	Manhours	Labor	Materials	Equipment	Subcontract	Indirects & Taxes	Total Cost
F145	Site Work Package	1	00L/S						340,278	340,278
P142	Support Facilities Package	1	00L/S						1,499,445	1,499,445
	WorkCode.01.00.PCD4 1.4.1.1 Construction Management Contingency	4	00L/S						7,338,960	7,338,960
	WorkCode.01.01.PDC3 1.4.1 Construction Management & Inspection.	8	00L/S						23,847,760	23,847,760
	1.4.2 Site Preparation Package,									
	1.4.2.0 Site Preparation Package									
F145	Site Work Package	1	00L/S	85,000	1,398,845	1,870,000	255,000	2,930,000	1,877,893	8,131,738
	WorkCode.01.00.PCD4 1.4.2.0 Site Preparation Package	1	00L/S	85,000	1,398,845	1,870,000	255,000	2,930,000	1,877,893	8,131,738
	WorkCode.01.01.PDC3 1.4.2 Site Preparation Package.	1	00L/S	85,000	1,398,845	1,870,000	255,000	2,930,000	1,877,893	8,131,738
	1.4.4 Process Facility Package,									
	1.4.4.0 Process Facility Package									
F144	Process Facility Package	1	00L/S	887,858	22,778,597	32,324,400	2,683,574	2,804,600	15,576,313	76,147,483
	WorkCode.01.00.PCD4 1.4.4.0 Process Facility Package	1	00L/S	887,858	22,778,597	32,324,400	2,683,574	2,804,600	15,576,313	76,147,483



Los Alamos National Laboratory
A-E/Partnering Services

Cost - Project Direct Cost Summary

Date: 12-12-97
Time: 10:15:27 AM

Project Title: PDCF Facility ROMTPC (Rev.002)
Project Number: PDCFPANTEX (80495-510)

Code Value	Description	Quantity	Unit	Manhours	Labor	Materials	Equipment	Subcontract	Indirects & Taxes	Total Cost
	WorkCode.01.01.PDC3 1.4.4 Process Facility Package.	1	00L/S	887,856	22,778,597	32,324,400	2,663,574	2,804,800	15,578,313	76,147,483
	1.4.5 Support Facilities Package.									
	1.4.5.0 Support Facilities Package									
SP142	Support Facilities Package	1	00L/S	238,879	5,881,478	19,825,910	718,037		10,388,566	36,771,991
	WorkCode.01.00.PCD4 1.4.5.0 Support Facilities Package	1	00L/S	238,879	5,881,478	19,825,910	718,037		10,388,566	36,771,991
	WorkCode.01.01.PDC3 1.4.5 Support Facilities Package.	1	00L/S	238,879	5,881,478	19,825,910	718,037		10,388,566	36,771,991
	1.4.6 Construction Contingency									
	1.4.6.0 Construction Contingency									
PF144	Process Facility Package	1	00L/S						34,266,366	34,266,366
PT001	Procurement	1	00L/S						21,759,205	21,759,205
PF145	Site Work Package	1	00L/S						3,659,282	3,659,282
SP142	Support Facilities Package	1	00L/S						16,547,398	16,547,398
	WorkCode.01.00.PCD4 1.4.6.0 Construction Contingency	4	00L/S						76,232,251	76,232,251

Cost - Project Direct Cost Summary

Date: 12-12-97
 Time: 10:15:27 AM

Project Title: PDCF Facility ROMTPC (Rev.002)
 Project Number: PDCFANTEX (80495-510)

Code Value	Description	Quantity	Unit	Manhours	Labor	Materials	Equipment	Subcontract	Indirects & Taxes	Total Cost
	WorkCode.01.01.PDC3 1.4.6 Construction Contingency	4.00	US						76,232,251	76,232,251
	1.5.1 Pre-Title I Activities									
	1.5.1.0 Pre-Title I Activities									
1.5.1.0	Pre-Title I Activities				5,000,000					5,000,000
	WorkCode.01.00.PCD4 1.5.1.0 Pre-Title I Activities				5,000,000					5,000,000
	1.5.1.1 Pre Title I Activities									
1.5.1.1	Pre-Title I Activities				2,500,000					2,500,000
	WorkCode.01.00.PCD4 1.5.1.1 Pre Title I Activities				2,500,000					2,500,000
	1.5.1.2 Pre Title I Licensing (SAR/Licensing Staff)									
1.5.1.2	Pre-Title I Activities				5,000,000					5,000,000
	WorkCode.01.00.PCD4 1.5.1.2 Pre Title I Licensing (SAR/Licensing Staff)				5,000,000					5,000,000
	1.5.1.3 Pre Title I Contingency									
1.5.1.3	Pre-Title I Activities				2,500,000					2,500,000
	WorkCode.01.00.PCD4 1.5.1.3 Pre Title I Contingency				2,500,000					2,500,000



Los Alamos National Laboratory
A-E/Partnering Services

Cost - Project Direct Cost Summary

Date: 12-12-97
Time: 10:15:27 AM

Object Title: PDCF Facility ROMTPC (Rev.002)
Object Number: PDCFPA NTEX (80495-510)

Code Value	Description	Quantity	Unit	Manhours	Labor	Materials	Equipment	Subcontract	Indirects & Taxes	Total Cost
5.1.4	NEPA Documentation							7,798,000		7,798,000
101	Material Disposition Guidance	1	100L/S					7,798,000		7,798,000
YorkCode 01.00.PCD4	1.5.1.4 NEPA Documentation	1	100L/S					7,798,000		7,798,000
YorkCode 01.01.PDC3	1.5.1 Pre-Title Activities					15,000,000		7,798,000		22,798,000
5.2	Testing & Startup									
5.2.0	Testing & Startup									
.152	Testing & Startup			600	56,856,000	4,546,480				61,404,480
YorkCode 01.00.PCD4	1.5.2.0 Testing & Startup			600	56,856,000	4,546,480				61,404,480
5.2.1	Testing & Startup Contingency									
.152	Testing & Startup			270	25,585,200	2,046,816				27,632,016
YorkCode 01.00.PCD4	1.5.2.1 Testing & Startup Contingency			270	25,585,200	2,046,816				27,632,016
YorkCode 01.01.PDC3	1.5.2 Testing & Startup			870	82,441,200	6,595,298				89,036,498
6.0	Operations									

Los Alamos National Laboratory
 A-E/Partnering Services

Cost - Project Direct Cost Summary

Date: 12-12-97
 Time: 10:15:27 AM

Project Title: PDCF Facility ROMTPC (Rev.002)
 Project Number: PDCFANTEX (80495-510)

Code Value	Description	Quantity	Unit	Manhours	Labor	Materials	Equipment	Subcontract	Indirects & Taxes	Total Cost
1.6.0.0	Operations									
P001	Operations & Maintenance			8,318,029	386,906,017	120,950,740	954,086	2,403,083	16,601,128	527,615,053
WorkCode.01.00.PCD4	1.8.0.0 Operations			8,318,029	386,906,017	120,950,740	954,086	2,403,083	16,601,128	527,615,053
WorkCode.01.01.PDC3	1.6.0 Operations			8,318,029	386,906,017	120,950,740	954,086	2,403,083	16,601,128	527,615,053
1.7.1	Decommissioning Cost									
1.7.1.0	Decommissioning Cost									
0117	Decontamination & Decommissioning	1	00L/S	127,211	3,154,087	9,526,263	381,634	961,233	6,640,451	20,663,668
WorkCode.01.00.PCD4	1.7.1.0 Decommissioning Cost	1	00L/S	127,211	3,154,087	9,526,263	381,634	961,233	6,640,451	20,663,668
WorkCode.01.01.PDC3	1.7.1 Decommissioning Cost	1	00L/S	127,211	3,154,087	9,526,263	381,634	961,233	6,640,451	20,663,668
1.7.2	Decommissioning Contingency									
1.7.2.0	Decommissioning Contingency									
D117	Decontamination & Decommissioning	1	00L/S	57,245	1,419,339	4,286,818	171,735	432,555	2,988,203	9,298,650
WorkCode.01.00.PCD4	1.7.2.0 Decommissioning Contingency	1	00L/S	57,245	1,419,339	4,286,818	171,735	432,555	2,988,203	9,298,650

Cost - Project Direct Cost Summary

Date: 12-12-97
Time: 10:15:27 AM

Project Title: PDCF Facility ROMTPC (Rev.002)
Project Number: PDCFPANTEX (80495-510)

Code Value	Description	Quantity	Unit	Manhours	Labor	Materials	Equipment	Subcontract	Indirects & Taxes	Total Cost
		1.00	US	57,245	1,419,339	4,288,818	171,735	432,555	2,888,203	9,298,650
	WorkCode 01.01.PDC3 1.7.2 Decommissioning Contingency									
	1.8.0 R & D									
	1.8.0.0 R & D									
	Material Disposition Guidance									
	1.00							104,549,000		104,549,000
	WorkCode 01.00.PCD4 1.8.0.0 R & D							104,549,000		104,549,000
	1.8.0 R & D							104,549,000		104,549,000
	WorkCode 01.01.PDC3 1.8.0 R & D							128,807,883	192,331,480	1,114,194,057
	Grand Total			10,168,665	537,714,102	251,817,008	5,323,787	128,807,883	192,331,480	1,114,194,057

Best Case Manhours	Estimated Manhours	Worst Case Manhours
--------------------	--------------------	---------------------

Code Value Description

Risk Function 90% Confidence

Unit Labor

Labor

Unit Materials

Materials

Unit Subcontract

Subcontract

Check Total

Unit Price Contingency Calculation

delta

1.2.2 Preliminary Design (Title I).

1.2.2.1	A/E Management (Title I)	40,290.00	42,531.20	53,184.00	78.40	3,338,082.00	0.49	20,752.50	1.28	54,536.25	3,413,370.75	3,069,156.64	555,785.89
1.2.2.2	Facility Design	9,499.50	12,032.00	16,566.45	74.69	900,078.68	2.16	26,016.00	5.74	69,056.00	995,750.68	1,222,783.75	227,043.07
1.2.2.3	Process Design	26,208.00	27,650.00	40,359.50	77.42	2,156,147.54	0.55	15,450.50	1.84	51,356.75	2,222,954.79	2,889,321.22	665,366.43
1.2.2.4	Mechanical Design	15,342.00	15,975.00	23,183.75	70.46	1,125,659.00	0.50	7,912.50	1.73	27,893.75	1,161,265.25	1,511,340.02	350,074.77
1.2.2.5	Electrical Design	5,940.00	6,290.00	9,120.50	74.84	470,757.30	0.50	3,165.00	1.76	11,077.50	484,999.80	629,979.97	144,980.17
1.2.2.6	Specifications	8,026.00	9,310.50	14,134.95	76.90	716,008.74	0.42	3,639.50	1.50	13,968.25	733,634.49	989,133.69	255,199.20
1.2.2.7	Systems Engineering	22,900.00	23,555.00	31,511.40	47.80	1,125,947.46	0.47	11,137.50	99.61	2,346,381.25	3,483,468.23	4,271,983.66	788,517.45

1.2.3 Detail Design (Title II).

1.2.3.1	A/E Management (Title II)	55,191.00	78,460.00	101,998.00	74.10	5,813,002.46	0.50	39,230.00	1.75	137,305.00	5,990,437.46	6,965,147.11	994,709.82
1.2.3.2	Site Design	14,082.00	14,554.60	19,879.98	75.97	1,061,988.83	0.50	7,277.40	1.75	25,470.90	1,094,747.13	1,350,015.13	255,268.00
1.2.3.3	Process/Building Structural package	16,100.00	17,140.00	23,998.00	73.14	1,253,970.72	0.50	6,570.00	3.50	59,995.00	1,322,235.72	1,872,568.76	350,323.04
1.2.3.4	Process Building Mechanical Internals Package	62,060.00	63,997.00	92,393.85	71.88	4,806,726.70	0.50	31,998.50	1.75	111,994.75	4,750,720.04	6,176,939.54	1,428,219.50
1.2.3.5	Process Building Electrical Internals Package	18,560.00	20,400.00	28,590.00	71.97	1,468,166.18	0.50	10,200.00	1.75	35,700.00	1,514,066.18	1,907,449.48	393,363.30

6,320.00	7,156.00	9,990.40
4,200.00	4,710.00	5,625.00
14,748.00	15,802.00	19,334.00
27,330.00	41,779.00	58,490.80

Process Building Architectural

1 2 3 6

Procurement Packages (Breakout SFE List)

1 2 3 7

Support Facilities Design

1 2 3 8

Systems Engineering

1 2 3 9

348,756.50 401,522.50 548,028.18

Grand Total

8,964.96	78.61	548,659.21	0.50	3,588.00	1.75	12,488.00	582,715.21	706,939.61	144,224.40
5,283.17	74.28	349,879.19	0.50	2,355.00	1.75	8,242.50	360,476.69	402,613.34	42,338.65
18,061.03	72.45	1,144,871.86	0.49	7,801.00	1.73	27,303.50	1,179,976.36	1,346,663.90	168,887.63
51,259.43	56.03	2,340,918.89	0.50	20,869.50	41.88	1,749,873.25	4,111,681.64	5,044,698.47	933,018.83
	70.78	28,420,092.90	0.35	220,262.90	11.81	4,742,462.65	33,382,816.45	41,077,934.39	7,895,115.94

Name	A/E Manag	Facility Desi	Process De	Mechanical	Electrical D	Specificatio	Systems En/A/E Manag	Site Design	Process/Bui	
Description	Output	Output	Output	Output	Output	Output	Output	Output	Output	
Cell	G22	G25	G28	G31	G34	G37	G40	G45	G48	G51
Minimum =	40398.66	9551.349	26372.92	15391.39	5948.687	8952.378	22937.69	55477.63	14093.93	16230.64
Maximum =	52955.3	16516.91	40226.74	23001.62	9098.563	14034.95	31329.14	101611.2	19598.36	23886.71
Mean =	45328.38	12699.3	31502.52	18160.21	7116.853	10790.5	25988.29	78549.7	16082.27	19108.71
Std Deviatio	2807.708	1461.705	3147.605	1773.606	712.0264	1185.066	1956.703	9555.676	1258.402	1738.887
Variance =	7883226	2136582	9907418	3145679	506981.5	1404381	3828687	91310940	1583575	3023729
Skewness	0.49889	0.26438	0.540388	0.551942	0.540267	0.554581	0.553675	0.00579	0.549769	0.534377
Kurtosis =	2.399662	2.4005	2.401302	2.398988	2.400398	2.400059	2.399605	2.401661	2.400863	2.400636
Errors Calc	0	0	0	0	0	0	0	0	0	0
Mode =	42666.9	12020.14	28023.88	15990.95	6297.951	9366.014	23593.32	78410.16	14544.9	17152.99
5% Perc =	41485.5	10444.23	27341.06	15837.23	6174.881	9241.815	23430.92	62558.59	14431.24	16798.6
10% Perc =	41985.06	10836.27	27771.75	16049.94	6273.316	9378.08	23657.83	65616.12	14586.54	17049.52
15% Perc =	42369.29	11136.5	28129.79	16249.39	6353.626	9511.994	23879.51	67961.88	14727.76	17250.52
20% Perc =	42697.36	11390.55	28494.63	16455.89	6436.304	9650.389	24106.83	69943.03	14874.71	17450.84
25% Perc =	43028.93	11612.87	28871.3	16668.37	6521.723	9792.788	24342.33	71683.02	15024.92	17658.62
30% Perc =	43373.18	11816.34	29261.6	16888.87	6609.53	9939.656	24583.65	73261.6	15181.61	17874.02
35% Perc =	43727.68	12001.11	29663.87	17117.98	6700.854	10093.25	24835.62	74711.47	15343.66	18097.75
40% Perc =	44099.59	12181.15	30084.6	17353.88	6796.122	10250.98	25096.88	76053.78	15510.69	18327.53
45% Perc =	44485.79	12366.92	30522.38	17600.84	6895.262	10416.23	25371.95	77323.21	15686.7	18569.24
50% Perc =	44889.88	12563.5	30979.21	17860.05	6998.08	10589.37	25657.19	78516.9	15869.9	18822.93
55% Perc =	45315.09	12768.28	31459.27	18131.33	7107.212	10770.88	25957.51	79719.53	16063.71	19086.7
60% Perc =	45762.96	12985.25	31969.02	18421.02	7221.897	10963.74	26274.71	80992.67	16266.79	19368.5
65% Perc =	46238.92	13217.37	32509.57	18726.98	7344.943	11167.52	26611.46	82353.3	16483.06	19665.06
70% Perc =	46755.3	13463.98	33092.27	19054.23	7476.235	11387.25	26974.81	83815.52	16717.37	19988.89
75% Perc =	47311.46	13733.58	33724.24	19413.44	7620.262	11627.09	27370.74	85399.43	16970.57	20335.09
80% Perc =	47930.39 47930.39	14092.7 14092.7	34424.46 34424.46	19809.32	7778.456	11892.71	27806.62	87144.09	17251.74	20722.2
85% Perc =	48627.91	14370.93	35218.43	20255.81	7957.879	12191.68	28301.73	89123.14	17568.71	21162.28
90% Perc =	49456.39	14775.44	36160.9	20790.82	8170.259	12547.89	28886.91	91488.25	17948.62	21681.2
95% Perc =	50536.13	15298.01	37393.34	21483.09	8447.17	13009.72	29651.5	94550.34	18439.64	22356.84

ET Data - Summary

Process Bui Process Bui Process Bui Procureme		Support Fa		Systems En	
Output	Output	Output	Output	Output	Output
G54	G57	G60	G63	G66	G69
62997.89	18628.21	6353.839	4218.544	14764.42	27680.74
91904.95	28420.3	9964.213	5603.789	19254.64	58048.66
73113.44	22506.58	7815.468	4845	16627.99	42533.24
6816.556	2172.802	786.7903	294.7536	980.6009	6365.679
46465430	4721071	619039.1	86879.66	961578.1	40521870
0.563302	0.490268	0.453784	0.265256	0.445447	0.070875
2.4004	2.399315	2.399874	2.399627	2.399647	2.399138
0	0	0	0	0	0
64437.91	20556.18	7159.36	4729.542	15860.17	42113.57
64214.91	19514.73	6705.722	4390.244	15238.25	32070.66
64963.01	19914.27	6867.039	4468.929	15441.82	34029.02
65735.75	20219.63	6989.826	4529.915	15599.42	35541.18
66532.63	20479.63	7093.165	4581.184	15730.58	36812.5
67350.15	20734.4	7186.615	4625.888	15848.38	37933.96
68197.96	20999.75	7282.301	4666.646	15965.93	38949.55
69075.42	21275.76	7380.541	4704.286	16088.81	39877.91
69995.51	21562.3	7482.493	4740.255	16215.64	40746.77
70941.75	21859.56	7589.448	4778.057	16348.69	41557.98
71939.37	22171.96	7701.458	4817.487	16486.84	42347.51
72992.41	22497.65	7817.967	4858.867	16632.83	43176.99
74100.35	22846.72	7942.873	4902.705	16787.48	44051.48
75281.9	23214.11	8074.882	4949.172	16952.21	44989.31
76548.31	23610.74	8216.362	4999.231	17129.58	45985.51
77925.7	24041.03	8370.911	5053.883	17319.76	47078.75
79451.36	24518.94	8541.709	5114.107	17532.29	48283.2
81172.82	25060.55	8735.378	5182.018	17774.83	49643.2
83236.56	25699.97	8964.963	5263.172	18061.03	51259.43
85911.2	26538.99	9263.82	5368.697	18433.5	53379.94

Client: Los Alamos National Laboratory
 Project: PDCFPANTEX (80495-510)

Los Alamos National Laboratory
 A-E/Partnering Services

Date: 12/12/97
 Time: 10:30:02 AM

Description: Worksheet: XXXX - Applications - Design Contingency WBS Level 4

Activity / Task Cost Worksheet Header

Estimator: RA Start Date:
 Revision: 02 12/12/97 End Date:

Quantity: 1.00 Unit: L/S Manhours: 0.000 Manhours/Drawing (if applicable) 0

Activity / WBS Codes

02.00 CPD3	09.C.1	Design Phase Contingencies
02.01 CPD2	09.C.	Contingencies
02.02 CPD1	09	Details of Cost Estimate

Formula Variables
 Global Variables 2,000,000 FTE Realized Hours per Annum
 FTE

Notes

All Worksheet Values Rounded to \$100.00
 Contingency amounts on this worksheet were calculated outside the G2 system based upon the percentages for the different WBS titles shown. The percentages used and the spreadsheet using the G2 totals are attached to the estimate as backup data

Rev.02 Contingency run at 90% Confidence Level

Line	Resource	Description	Quantity	Unit	Unit Manhours	Unit Labor	Unit Labor	Unit Materials	Unit Materials	Unit Equipment	Unit Equipment	Unit Subcontract	Unit Subcontract	Unit Indirects & Taxes	Total Cost
1.00	CONT1221	Contingency A/E Management Title I	55,726.89	L/S											
	01.00 PCD4	A/E Management (Title I)	1 2 2 1												
	01.01 PDC3	Preliminary Design (Title I)	1 2												
	01.02 PDC2	Engineering Design, (Title I)	1												
	01.03 PDC1	Design Phase Contingencies	09 C.1												
	02.00 CPD3	Contingencies	09 C.												
	02.01 CPD2	Details of Cost Estimate	09												
	02.02 CPD1														
2.00	CONT1222	Contingency Facility Design	27,043.07	L/S											
	01.00 PCD4	Facility Design	1 2 2 2												
	01.01 PDC3	Preliminary Design (Title I)	1 2												
	01.02 PDC2	Engineering Design, (Title I)	1												
	01.03 PDC1	Design Phase Contingencies	09 C.1												
	02.00 CPD3	Contingencies	09 C.												
	02.01 CPD2	Details of Cost Estimate	09												
	02.02 CPD1														
3.00	CONT1223	Contingency Process Design	83,366.43	L/S											
	01.00 PCD4	Process Design	1 2 2 3												

PRELIMINARY FOR REVIEW ONLY

Client: Los Alamos National Laboratory
 Project: PDCFANTEX (80495-510)

Date: 12/12/97
 Time: 10:30:02 AM

Los Alamos National Laboratory
 A/E/Partnering Services

Description: Worksheet: XXXX - Applications - Design Contingency WBS Level 4

Line	Resource	Description	Quantity	Unit	Manhours	Unit Labor	Materials	Unit Materials	Equipment	Unit Equipment	Subcontract	Unit Subcontract	Indirects	Unit Indirects	Taxes	Total Cost
3.00		01.01 PDC3 1.2.2 Preliminary Design (Title I), 01.02 PDC2 1.2 Engineering Design, 02.00 CPD3 09 C.1 Design Phase 02.01 CPD2 09 C Contingencies 02.02 CPD1 09 Details of Cost Estimate											1.00		350,100	\$350,100
4.00		4.00 CONT1224 Contingency Mechanical Design 50,074.17 US 01.00 PCDA 1.2.4 Mechanical Design 01.01 PDC3 1.2 Preliminary Design (Title I), 01.02 PDC2 1.2 Engineering Design, 02.00 CPD3 09 C.1 Design Phase 02.01 CPD2 09 C Contingencies 02.02 CPD1 09 Details of Cost Estimate											1.00		145,000	\$145,000
5.00		5.00 CONT1225 Contingency Electrical Design 44,990.17 US 01.00 PCDA 1.2.5 Electrical Design 01.01 PDC3 1.2 Preliminary Design (Title I), 01.02 PDC2 1.2 Engineering Design, 02.00 CPD3 09 C.1 Design Phase 02.01 CPD2 09 C Contingencies 02.02 CPD1 09 Details of Cost Estimate											1.00		255,200	\$255,200
6.00		6.00 CONT1226 Contingency Specifications 55,100.20 US 01.00 PCDA 1.2.6 Specifications 01.01 PDC3 1.2 Preliminary Design (Title I), 01.02 PDC2 1.2 Engineering Design, 02.00 CPD3 09 C.1 Design Phase 02.01 CPD2 09 C Contingencies 02.02 CPD1 09 Details of Cost Estimate											1.00		788,500	\$788,500
7.00		7.00 CONT1227 Contingency Systems Engineering 88,517.45 US														

PRELIMINARY FOR REVIEW ONLY

Description: Worksheet: XXXX - Applications - Design Contingency WBS Level 4

Line	Resource	Description	Quantity	Unit	Manhours	Labor	Unit	Materials	Equipment	Unit	Subcontract	Subcontract	Unit	Indirects	Indirects & Taxes	Total Cost
7.00		Systems														
	01.00 PCD4	1227 Engineering														
	01.01 PDC3	122 Preliminary Design														
	01.02 PDC2	12 (Title I),														
	01.03 PDC1	1 Engineering Design,														
	02.00 CPD3	09 C.1														
	02.01 CPD2	09 C.														
	02.02 CPD1	09 Design Phase														
		Contingencies														
		Details of Cost														
		Estimate														
8.00	CONT1231	Contingency A/E Management (Title II), 04.709.62														
	01.00 PCD4	1231 A/E Management														
	01.01 PDC3	123 (Title II)														
	01.02 PDC2	1 Detail Design (Title														
	01.03 PDC1	1 II),														
	02.00 CPD3	09 C.1 Engineering Design,														
	02.01 CPD2	09 C														
	02.02 CPD1	09 Design Phase														
		Contingencies														
		Details of Cost														
		Estimate														
9.00	CONT1232	Contingency Site Design														
	01.00 PCD4	1232 Site Design														
	01.01 PDC3	123 Detail Design (Title														
	01.02 PDC2	1.2 II),														
	01.03 PDC1	1 Engineering Design,														
	02.00 CPD3	09 C.1														
	02.01 CPD2	09 C.														
	02.02 CPD1	09 Design Phase														
		Contingencies														
		Details of Cost														
		Estimate														
10.00	CONT1233	Contingency Process/Building														
	01.00 PCD4	1233 Process/Building														
	01.01 PDC3	123 Structural package														
	01.02 PDC2	12 Detail Design (Title														
	01.03 PDC1	1 II),														
	02.00 CPD3	09 C.1 Engineering Design,														
	02.01 CPD2	09 C														
	02.02 CPD1	09 Design Phase														
		Contingencies														
		Details of Cost														
		Estimate														

PRELIMINARY FOR REVIEW ONLY

Description: Worksheet: XXXX - Applications - Design Contingency WBS Level 4

Line	Resource	Description	Quantity	Unit	Manhours	Unit	Labor	Unit	Materials	Unit	Equipment	Unit	Subcontract	Unit	Indirects	Unit	Indirects & Taxes	Total Cost
10.00		Estimate													1.00		1,428,200	\$1,428,200
11.00	CONT1234	Contingency Process Building Mechanical Internals Package		US	28,219.50													
		01.00 PCD4 Process Building																
		01.01 PDC3 Mechanical Internals																
		01.02 PDC2 Package																
		01.03 PDC1 Detail Design (Title I),																
		02.00 CPD3 Engineering Design, 09 C 1																
		02.01 CPD2 09 C																
		02.02 CPD1 09																
		Contingencies																
		Details of Cost																
		Estimate																
12.00	CONT1235	Contingency Process Building Electrical Internals Package		US	93,363.30												383,400	\$383,400
		01.00 PCD4 Process Building																
		01.01 PDC3 Electrical Internals																
		01.02 PDC2 Package																
		01.03 PDC1 Detail Design (Title I),																
		02.00 CPD3 Engineering Design, 09 C 1																
		02.01 CPD2 09 C																
		02.02 CPD1 09																
		Contingencies																
		Details of Cost																
		Estimate																
13.00	CONT1236	Contingency Process Building Architectural		US	44,224.40												144,200	\$144,200
		01.00 PCD4 Process Building																
		01.01 PDC3 Architectural																
		01.02 PDC2 Detail Design (Title I),																
		01.03 PDC1 Engineering Design, 09 C 1																
		02.00 CPD3 09 C																
		02.01 CPD2 09																
		02.02 CPD1																
		Contingencies																
		Details of Cost																
		Estimate																

PRELIMINARY FOR REVIEW ONLY



Date: 12/12/97
 Time: 10:30:02 AM

Los Alamos National Laboratory
 A-E/Partnering Services

Description: **Worksheet: XXXX - Applications - Design Contingency WBS Level 4**

Line	Resource	Description	Quantity	Unit	Manhours	Unit	Labor	Unit	Materials	Unit	Equipment	Unit	Subcontract	Unit	Indirects	Unit	Indirects & Taxes	Total Cost
14.00	CONT1237	Contingency Procurement Packages (Breakout SFE List)	42,336.65	L/S											1.00	42,300	\$42,300	
	01.00	PCD4	1.2.3.7															
	01.01	PDC3	1.2.3															
	01.02	PDC2	1															
	01.03	PCD1	1															
	02.00	CPD3	09.C.1															
	02.01	CPD2	09.C.															
	02.02	CPD1	09															
			Procurement Packages (Breakout SFE List)															
			Detail Design (Title II), Engineering Design, Design Phase Contingencies Details of Cost Estimate															
15.00	CONT1238	Contingency Support Facilities Design	69,687.63	L/S											1.00	166,700	\$166,700	
	01.00	PCD4	1.2.3.8															
	01.01	PDC3	1.2.3															
	01.02	PDC2	1.2															
	01.03	PDC1	1															
	02.00	CPD3	09.C.1															
	02.01	CPD2	09.C.															
	02.02	CPD1	09															
			Support Facilities Design, Detail Design (Title II), Engineering Design, Design Phase Contingencies Details of Cost Estimate															
16.00	CONT1239	Contingency Systems Engineering	33,016.63	L/S											1.00	933,000	\$933,000	
	01.00	PCD4	1.2.3.9															
	01.01	PDC3	1.2.3															
	01.02	PDC2	1.2															
	01.03	PDC1	1															
	02.00	CPD3	09.C.1															
	02.01	CPD2	09.C.															
	02.02	CPD1	09															
			Systems Engineering, Detail Design (Title II), Engineering Design, Design Phase Contingencies Details of Cost Estimate															
Sheet Totals: 1.00 L/S																		

PRELIMINARY FOR REVIEW ONLY