

Copy 67 of 114

Series A

LOS ALAMOS NATIONAL LABORATORY



3 9338 00419 5706

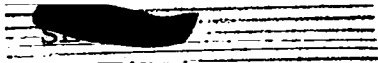

UNCLASSIFIED

LOS ALAMOS SCIENTIFIC LABORATORY

of

UNIVERSITY OF CALIFORNIA

PUBLICLY RELEASABLE
LANL Classification: G1
A. Jam 11/16/95

As of Dec. 31, 1945

LA-1236

This document consists of 29 pages



Chapter 3

BERYLLIUM OXIDE

of

Volume 10

METALLURGY

Cyril S. Smith

Classification changed to UNCLASSIFIED
by authority of the U. S. Atomic Energy Commission,

Per *H. J. Carroll* *Set #3* 3-2-52

By REPORT LIBRARY *M. Miller*

4-3-56

METALLURGY AND CERAMICS

UNCLASSIFIED

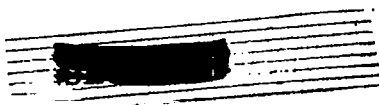

LOS ALAMOS NATL. LAB. LIBS



3 9338 00419 5706

UNCLASSIFIED

METALLURGY AND CERAMICS

MAY 26 1951

Los Alamos	1-20
<u>Standard Distribution</u>	<u>No. of Copies</u>
Argonne National Laboratory	21-28
Atomic Energy Commission, Washington	29-36
Battelle Memorial Institute	37
Brookhaven National Laboratory	38-41
Brush Beryllium Company	42
Bureau of Ships	43
Carbide and Carbon Chemicals Division (K-25 Plant)	44-45
General Electric Company, Richland	46-49
Hanford Operations Office	50
Idaho Operations Office	51-52
Iowa State College	53
Knolls Atomic Power Laboratory	54-57
Mallinckrodt Chemical Works	58
Massachusetts Institute of Technology (Kaufmann)	59
Mound Laboratory	60-62
National Advisory Committee for Aeronautics	63
National Bureau of Standards	64
NEPA Project	65-67
New York Operations Office	68-72
North American Aviation, Inc.	73
Oak Ridge, National Laboratory, X-10 Site	74-79
Carbide and Carbon Chemicals Div. (Y-12 Area)	80-83
Patent Branch, Washington	84
Sylvania Electric Products, Inc.	85
Technical Information Service, Oak Ridge	86-100
University of California Radiation Laboratory	101-104
Westinghouse Electric Corporation	105-108
Chicago Patent Group	109
Du Pont Company	110-112
New Operation Office	113
New Brunswick Laboratory	114
	114

UNCLASSIFIED



UNCLASSIFIED

Chapter 3

BERYLLIUM OXIDE

TABLE OF CONTENTS

3.0	Introduction
3.1	Early Experiments
3.2	Production of Hot-Pressed Bricks
3.3	Consolidation of BeO by Sintering and Impregnation

UNCLASSIFIED

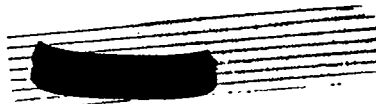

UNCLASSIFIED

3.0 INTRODUCTION

The first production job undertaken by the Metallurgy Groups at Los Alamos was that of the specially-shaped high-density beryllium oxide bricks needed for the Water Boiler.

Hot-pressing of BeO powder was found to be the most satisfactory method of obtaining intricately-shaped bricks of suitable density. This was accomplished by charging the powder into a graphite die, or mold, of suitable shape fitted with a punch, or plunger, of graphite. The die and contents were heated to about 1700°C by means of an induction coil connected to a high-frequency converter. During the heating period a pressure of 1000 psi was applied to the plunger, thus consolidating the semi-plastic BeO powder into a dense coherent mass of the shape of the die.

Owing to the pressure of the time schedule, which did not allow more than a few weeks for the preliminary experimental program preceding actual production of the large tamper bricks for the Water Boiler, there is not a great deal of data worth reproduction in detail.

3.1 EARLY EXPERIMENTS

The early experiments included impregnation of low-density cold-pressed bricks with fused MgF_2 . At first, temperatures of about 1350°C were used with pressures of 1000 psi. The load was applied in a 10-ton Carver laboratory press, and the shape was a disc one inch in diameter and one-half inch high. A density of 2.37 gm/cc was obtained. (Crystal density of BeO is 3.03.) On raising the temperature to 1700°C, a density of 2.69 gm/cc was found. The load was maintained for five minutes at temperature in these experiments.

A little later several runs were made, investigating the following variables: (a) extent of subdivision of the BeO powder, (b) temperature,

UNCLASSIFIED

(c) time at maximum temperature, (d) pressure, (e) use of double-acting die, and (f) use of BeO slugs cold-pressed at 5-10 tons/sq in instead of powder fill in the hot-pressing die.

The shape used was a small brick $1/2 \times 1/2 \times 1$ inch, pressed normal to the $1/2 \times 1/2$ -inch face.

1. Particle Size

The highest density was obtained in using the finest powder (-325 mesh). This was the Brush Beryllium Company's "GC High Fired" grade. Pressing at 1700°C for five minutes at 1000 psi resulted in a density of 2.85 gm/cc. The maximum density obtained during the entire investigation was 2.90 gm/cc (see Figure 1).

2. Temperature

Figure 2 shows the effect on 1-inch bricks of both temperature and pressure over a fairly wide range. The higher the temperature, up to 1900°C , the higher the density. BeO carburizes to beryllium carbide at the higher temperatures, starting appreciably at 1600°C . However, the reaction is fairly slow, and the over-all density increases even at the highest temperatures used. If minimum carbide formation is desired, some compromise must be made between density and carbide formation.

3. Pressure

The density increases quite rapidly with higher pressure, and in the range between 1700 - 1900°C , increasing pressure from 1000-3000 psi has a far greater influence on density than temperature (Figure 2).

It was found that 20 minutes was about the maximum time for showing improvement in density. Beyond this, density did not improve appreciably, but carbide was formed. Figure 3 shows a curve of plunger movement vs time, drawn for several runs.

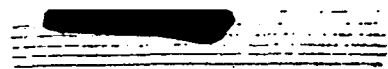
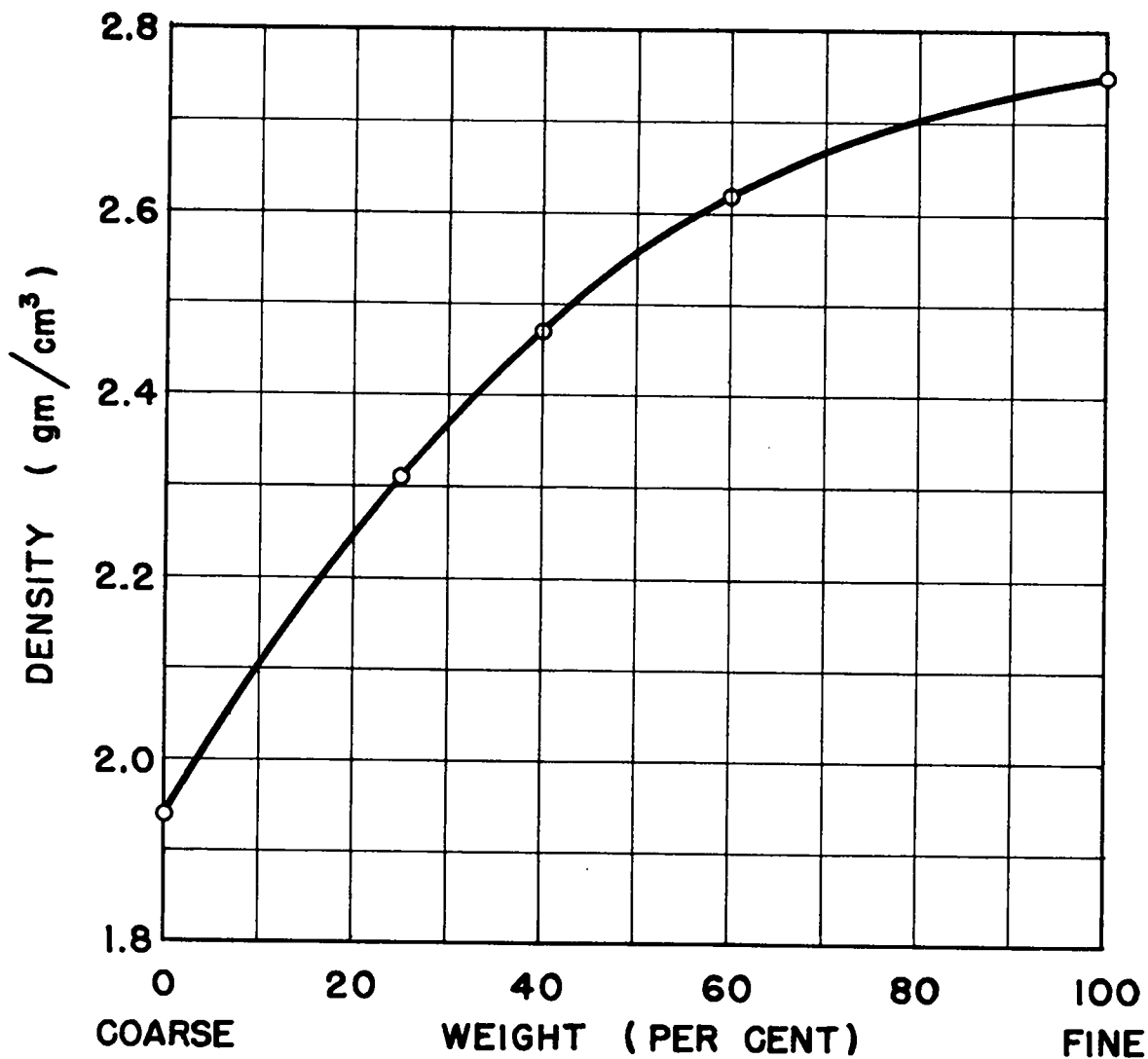

Figure 1

Influence of particle-size mixture on density of hot-pressed beryllium oxide compacts. Pressure 1000 psi at 1700°C for five minutes. 1/2 x 1/2 x 1-inch bricks.





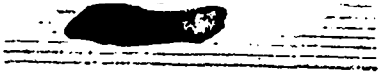

Figure 2

Influence of temperature on density of hot-pressed BeO bricks.



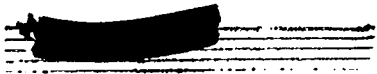
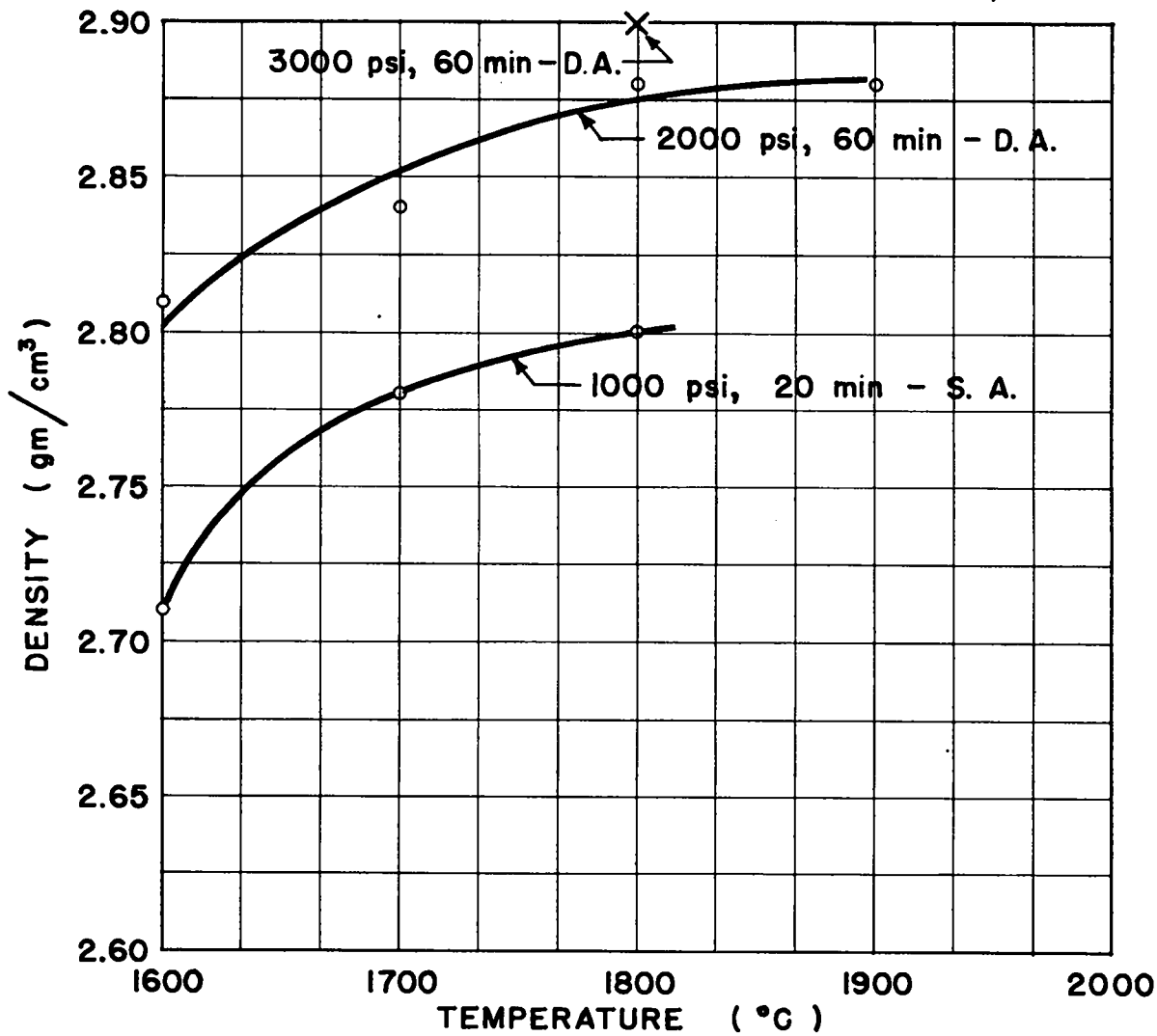
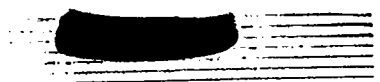
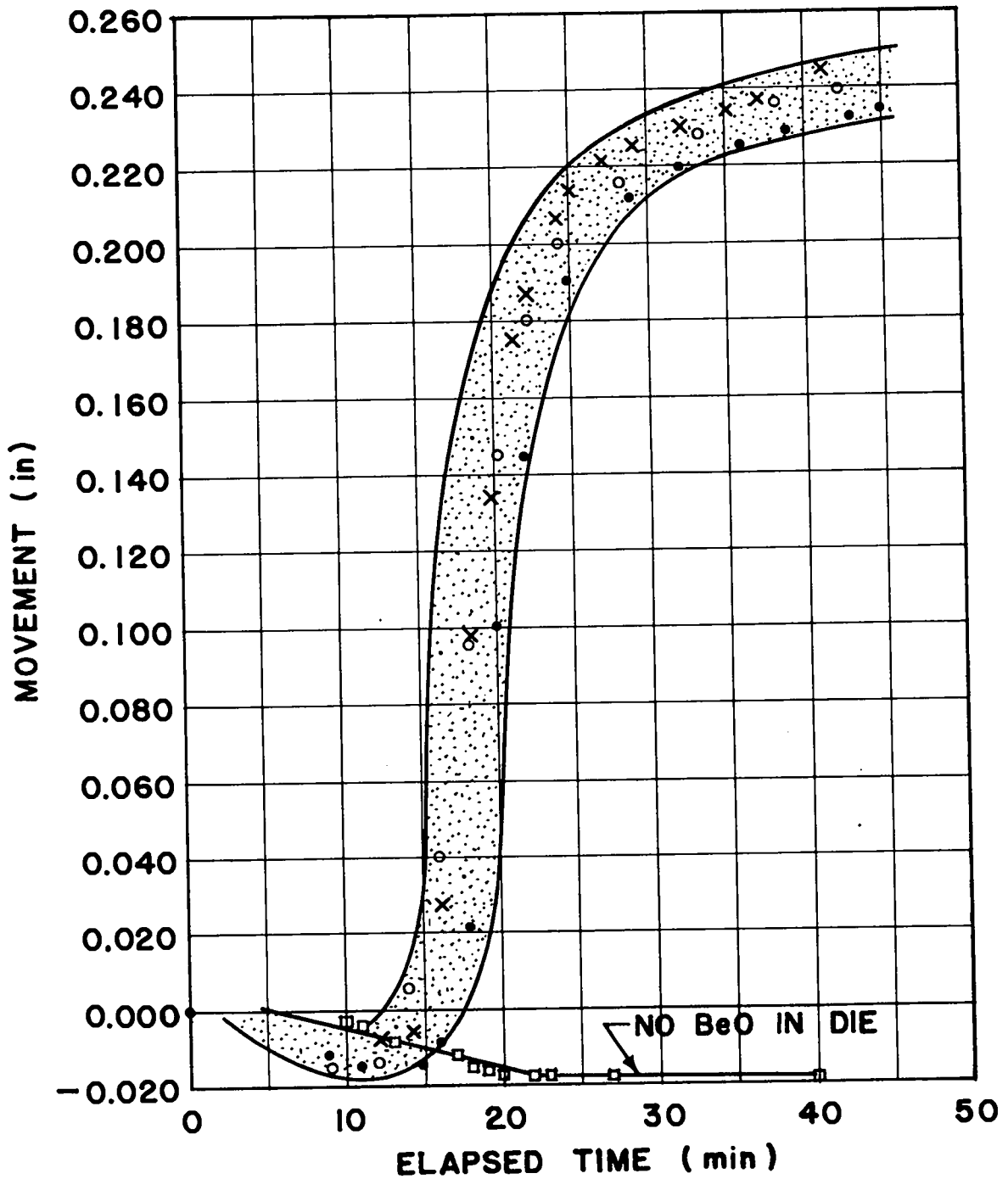
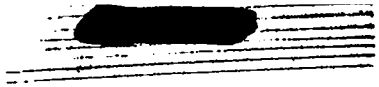

Figure 3
Movement of plunger in die during hot-pressing operation.
1/2 x 1/2 x 1-inch brick.



4. Use of Double-Acting Die

Figure 4 shows the double-acting feature in which the die body is floating over the lower plunger. This arrangement allows equal consolidation at the top and bottom of the pressed piece. Such a die allows appreciable improvement in density, especially on shapes which are long, compared to length and width, and which are pressed in the long direction. A typical density improvement in the case of the 1/2 x 1/2 x 1-inch bricks is from 2.86-2.88 gm/cc.

5. Use of a Pre-Pressed Compact

The main advantage in preliminary cold-pressing was found in the shaped bricks which were made to fit around a sphere. Rectangular bricks of 1/2 x 1/2 x 1 inch were pressed in a steel die at about 10 tons/sq in. They were strong enough to handle, and could be shaped with a knife or file to a sharp edge and then hot-pressed. In this way the BeO could project into odd-shaped corners of the graphite hot-pressing die. Thus it was possible to obtain the compression of regions where the compression ratio was not favorable.

6. Production of Small Sample Shaped Bricks

Before production was begun on the large bricks, 3 x 3 x 6 inches, both plain and shaped to fit around a sphere, the same shapes were made on the 1/2 x 1/2 x 1-inch scale. A photograph of these appears as Figure 5. Die designs for two shapes which clearly illustrate the principles used are shown in Figures 6 and 7. The oxide was first cold-pressed in a steel die to 1/2 x 1/2 x 1 inch and then rough-shaped by hand. The rough-shaped, cold-pressed shapes were then introduced into a graphite die of the type shown in Figures 4, 6 or 7.

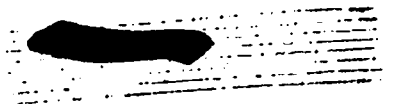
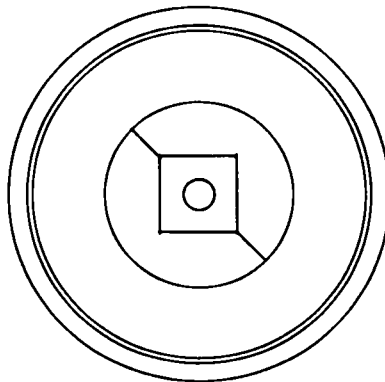
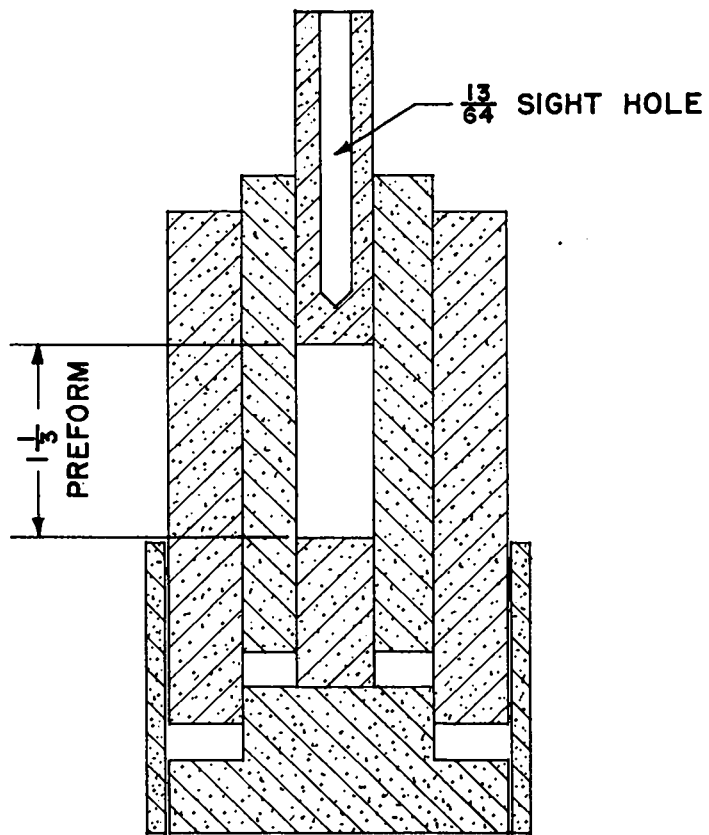

Figure 4
Graphite die for hot-pressing 1/2 x 1/2 x 1-inch
bricks (double-acting).





PLAN



SECTION

NOTE :
DENSITY PREFORMED BRICKS < 2.2 gm/cc
" HOT PRESSED " > 2.8 "

Figure 5
Hot-pressed shapes of beryllium oxide.

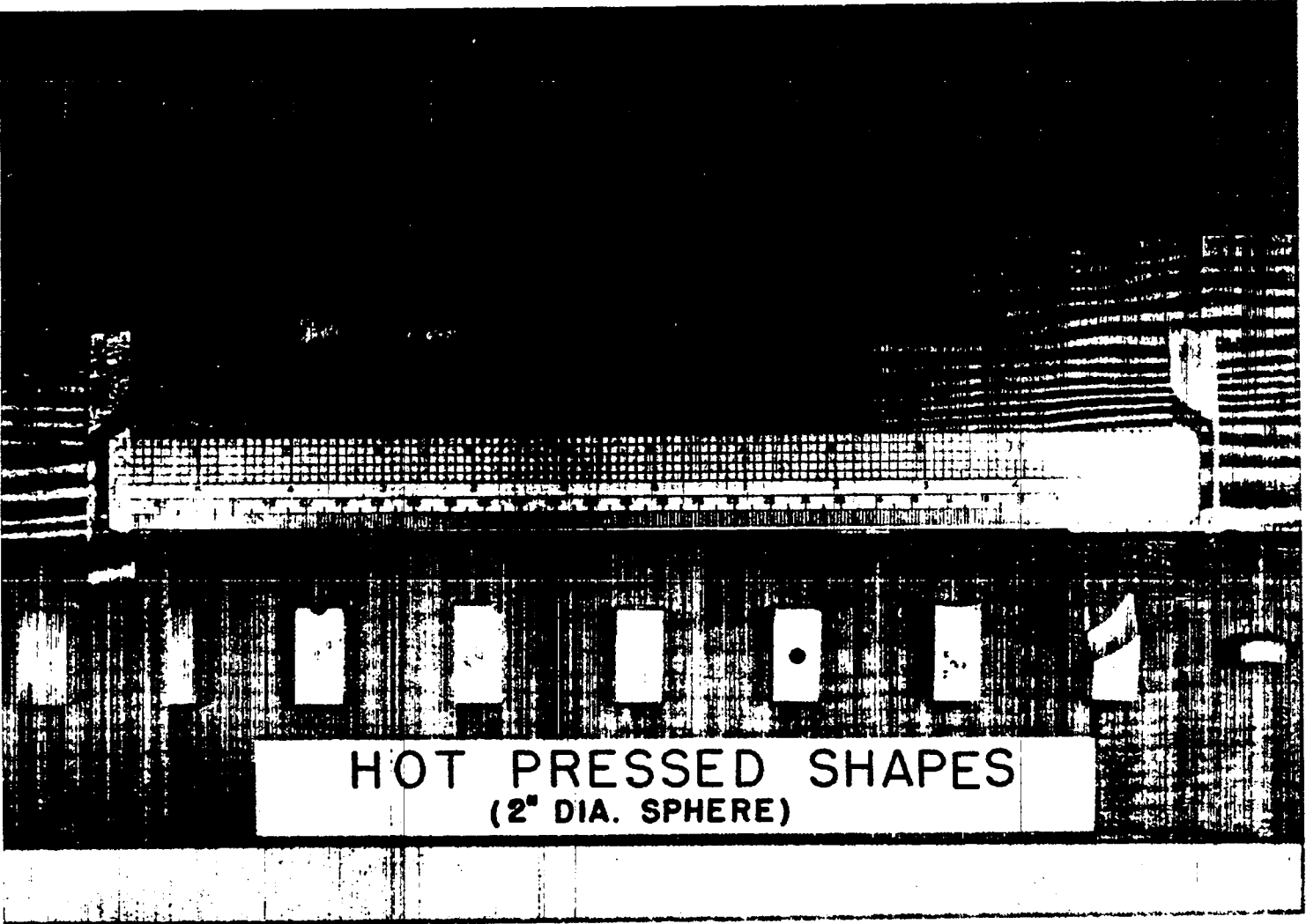

HOT PRESSED SHAPES
(2" DIA. SPHERE)

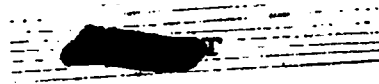
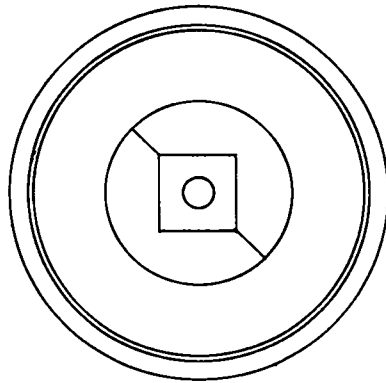
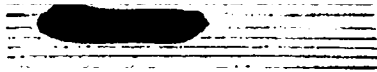
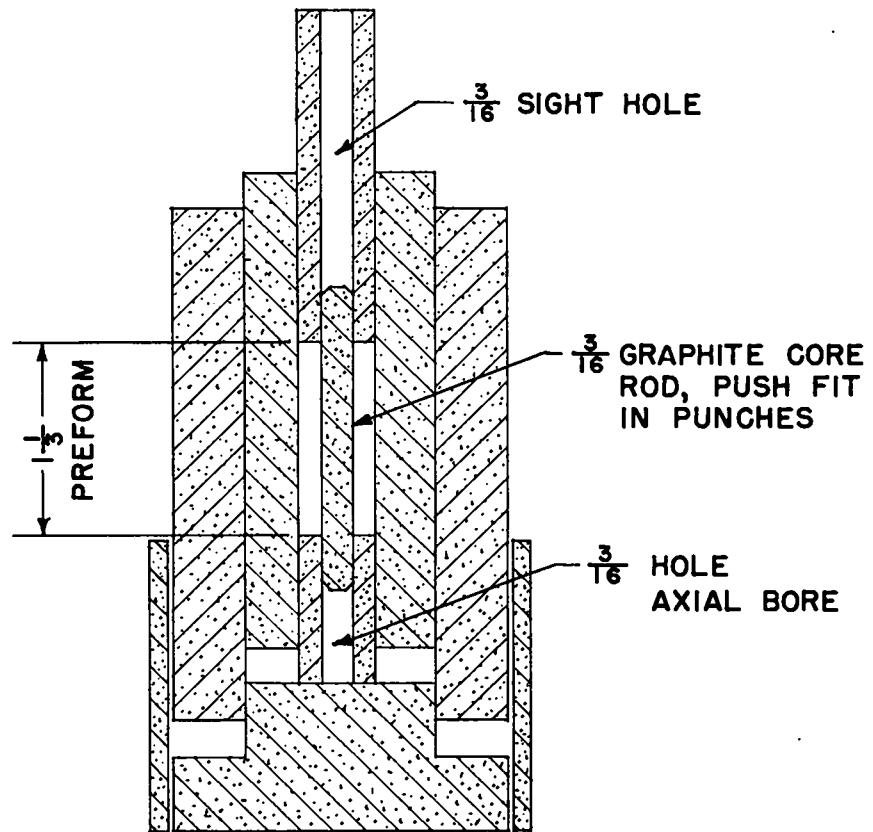

Figure 6
Punch design for hot-pressing brick with axial hole.





PLAN



SECTION

NOTE :
DENSITY PREFORMED BRICKS < 2.2 gm/cc
" HOT PRESSED " > 2.8 "



Figure 7

**Punch design for pressing brick with spherical
segment removed.**

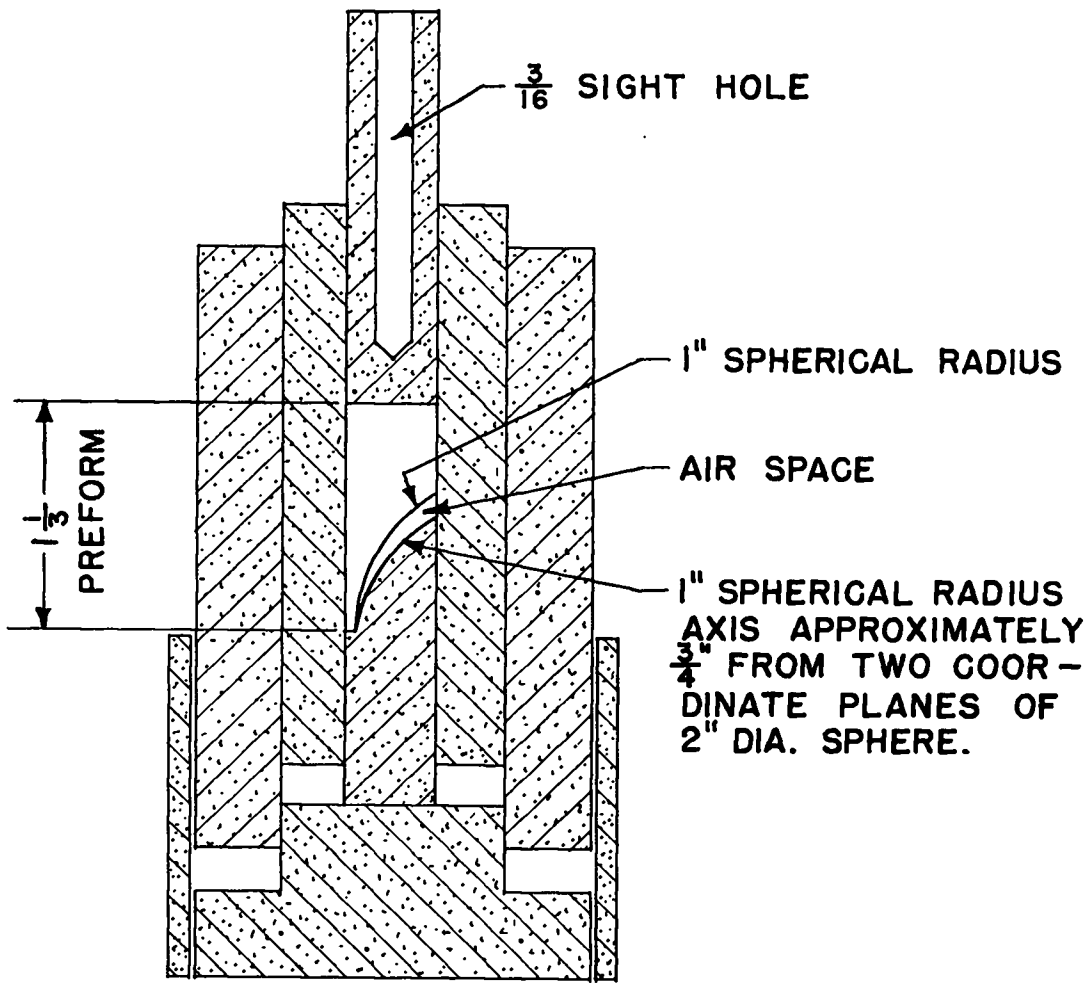
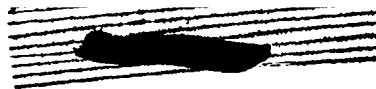

SECTION

NOTE :

DENSITY PREFORMED BRICKS < 2.2 gm/cc
" HOT PRESSED " > 2.8 "





3.2 PRODUCTION OF HOT-PRESSED BRICKS

Almost before the experimental work was completed, production had to be started on 3 x 3 x 6-inch bricks for the actual boiler. The simple shapes were made commercially following methods developed at Los Alamos, but all of the special curvatures were made at Los Alamos. BeO powder was pre-pressed into brick form, fired to 1250°C to enable it to be handled, shaped to fit the dies, and then hot-pressed to final shape. The pre-pressed density was 2.10 ± 0.05 gm/cc; the final hot-pressed density was 2.70-2.80 gm/cc. Pressure was applied during the hot-pressing operation by means of Manley hand-operated hydraulic presses of the simple square-frame type.

The sequence of operations was as follows: The screened and calcined BeO powder was moistened with water to the desired consistency (found by experience), and 1920 gm were pressed in the 3 x 3 x 6-inch die at 15 tons/sq in. The die, made of Crocar steel and demountable to allow removal of the very delicate bricks, is shown in Figures 8(a) and (b). The brick was then dried for several hours at a low temperature. Six such bricks were placed on graphite slabs in a Hays globar furnace, heated to 1250°C in five hours, and held at temperature for three hours. At this stage, the density was about 2.2 gm/cc.

The bricks, after cooling, were now ready for hand-shaping prior to hot-pressing. Because BeO, even when hot, has so little plasticity, it was necessary to shape the bricks to nearly the shape of the die cavity. The shape of the cut bricks was elongated, or exaggerated, in the pressing direction so that the thinner sections projecting out from the square part of the bricks, and the more massive portions, would be compressed equally. The graphite die is shown in Figure 9.

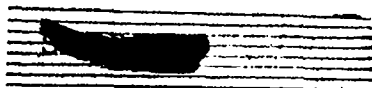

Figure 8a

Steel die for pre-pressing BeO bricks (elevation).

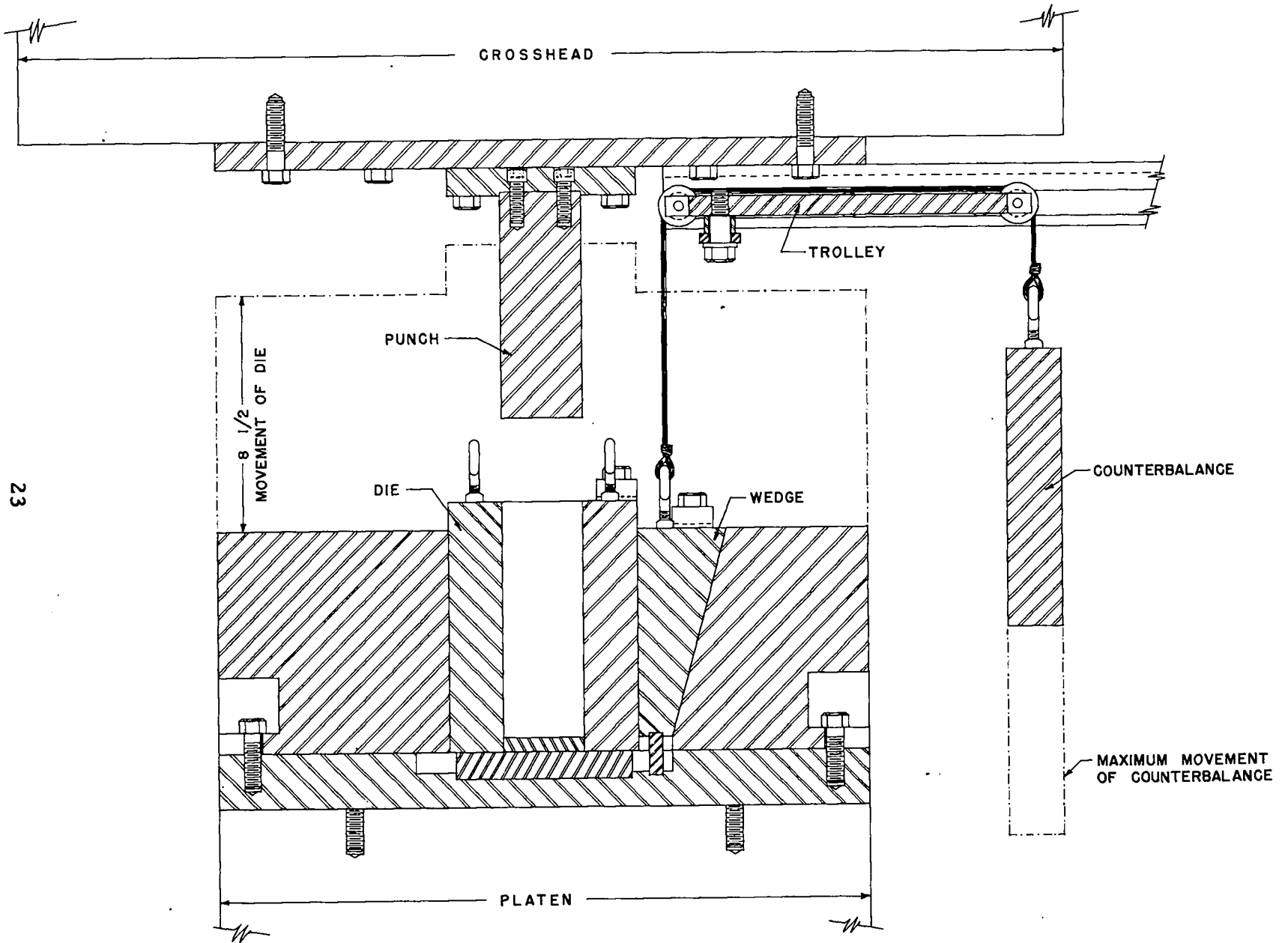

Figure 8b
Steel die for pre-pressing BeO bricks (plan).

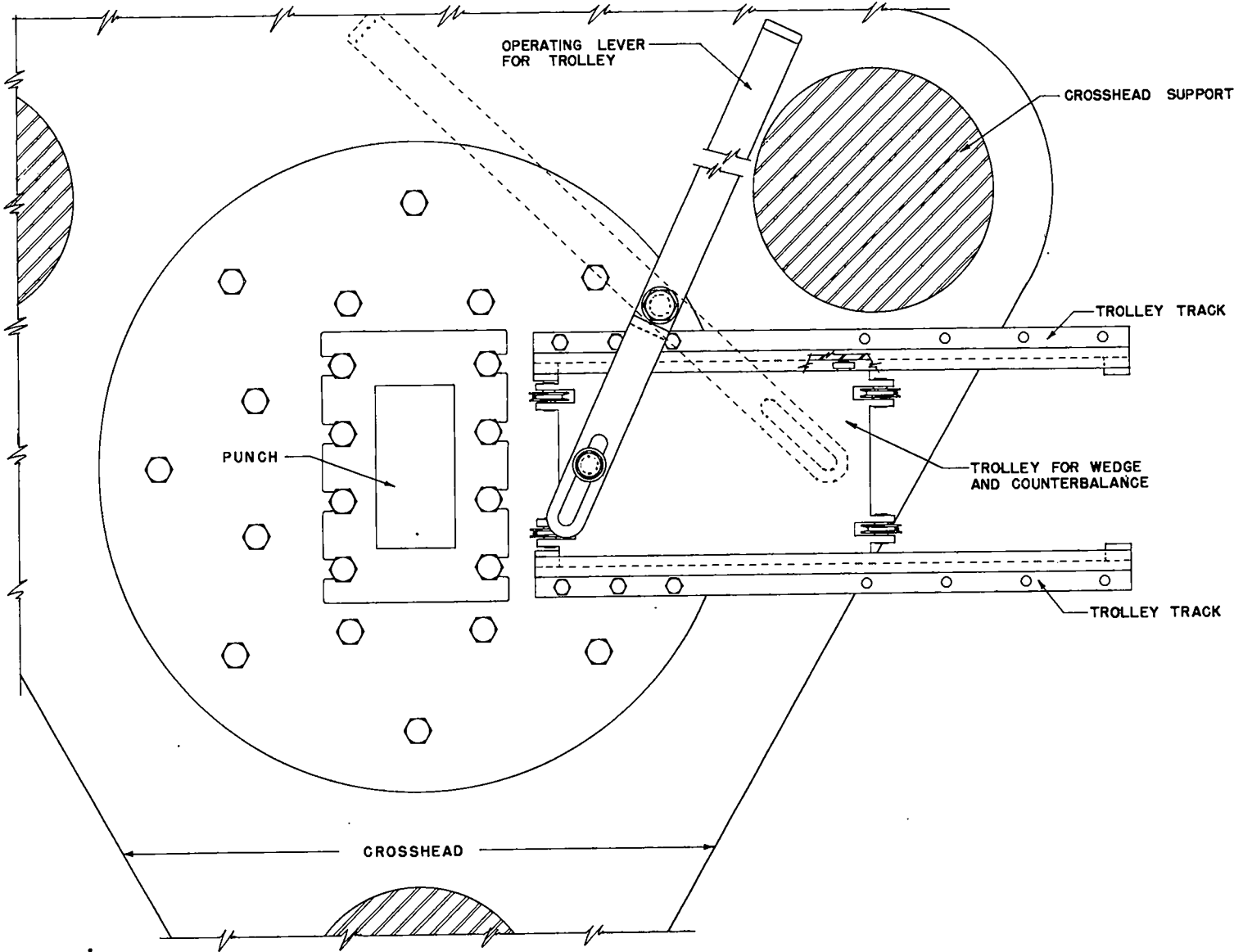
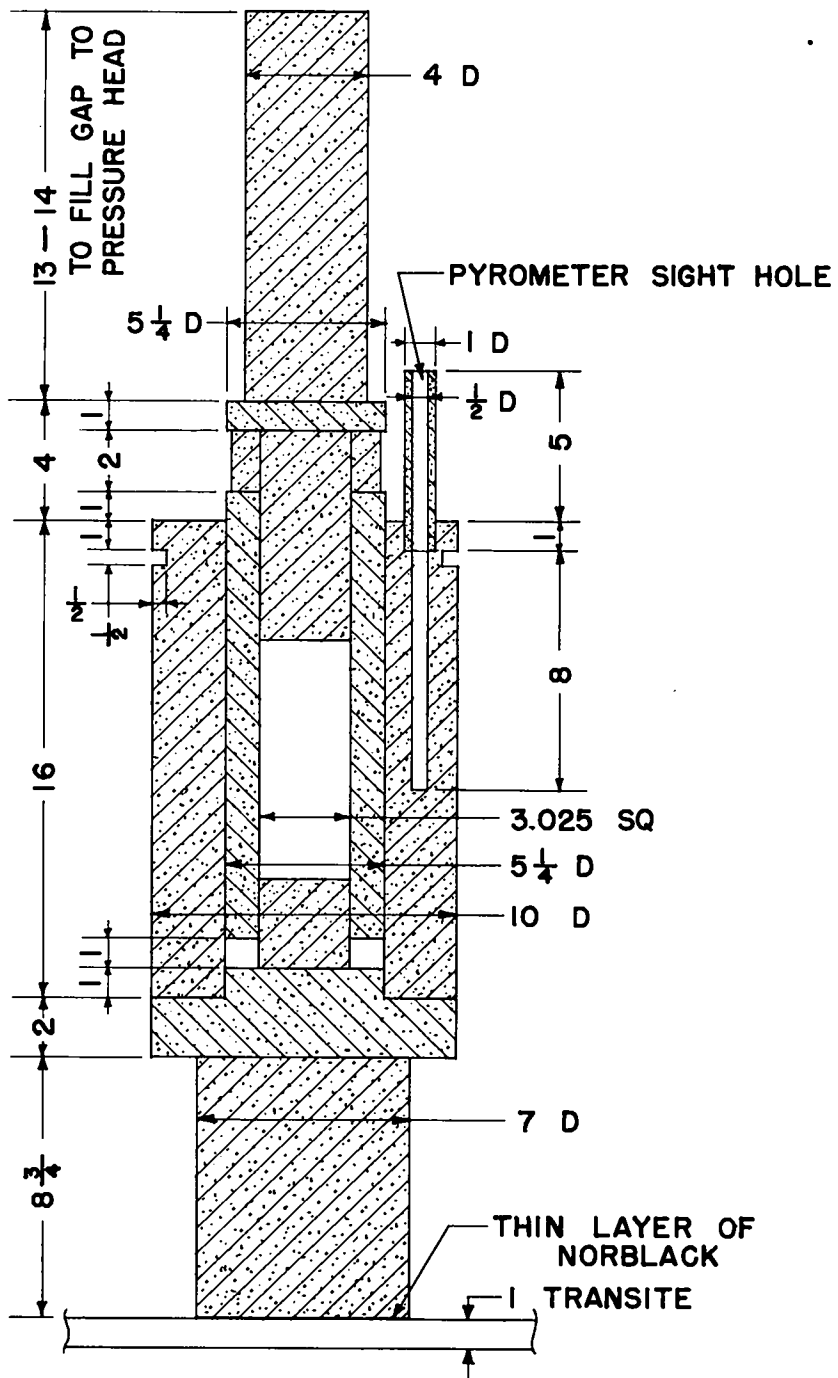



Figure 9

Graphite die for hot-pressing 3 x 3 x 6-inch bricks of BeO.





NOTE :
 PRESSING MOVEMENT 2 IN 8 (APPROX)
 ALL DIMENSIONS IN INCHES

Inserts gave the curved faces on the bricks. The die was heated by a 100-kw high-frequency motor generator. Pressure was applied by a simple open-frame mechanics hand press.

The hot-pressing cycle required about four hours, and the maximum temperature (1800°C) was held for approximately one hour. The pressure was 2000 psi. On starting up, about 70 kw of power were used in the induction coil surrounding the graphite die. Near the end of the run the power was cut down to about 20 kw. To save time, the graphite dies and contents, while still very hot ($1000\text{-}1200^{\circ}\text{C}$), were pulled out of the lampblack thermal insulation and set outdoors for rapid cooling. A new charged die was then placed in the press.

Most of the bricks were so close to the required size that no finishing by grinding was required. However, there were a few whose location in the pile was such that very critical dimensions were required. These were ground somewhat to permit a closer fit with adjacent bricks. The bricks had satisfactory density, varying from approximately 2.70 to 2.80 gm/cc.

3.3 CONSOLIDATION OF BeO BY SINTERING AND IMPREGNATION

In the early days of the work, attempts were made to obtain high density by the conventional methods of pressing and sintering. Although this gave a satisfactory body for most refractory uses, the density was far too low to permit its use as a tamper or moderator. Further experiments were made by impregnating the bricks with fused magnesium fluoride to increase the nuclear density.

Pressed densities of 1.6-1.9 were obtained, the highest being with -325-mesh powder mixed with stearic acid. Sintering at 1350°C (the temperature being limited by furnaces available at the time) gave a

maximum density of about 2.2.

Nearly-theoretical densities could be obtained when the pressed-sintered compacts were immersed in molten MgF_2 . The compacts were preheated to 1450°C , lowered into the bath at the same temperature, allowed to remain for 15 minutes, removed and drained.

These two methods were so inferior to that of the hot-press, both as to process and product, that further work on them was abandoned shortly after the inception of hot-pressing.

DOCUMENT ROOM

REC. NO. SQ

DATE 5-16-51

REC. NO. REC.

