

SPECIAL RE-REVIEW
FINAL DETERMINATION
UNCLASSIFIED, DATE: 7/17/80

UNCLASSIFIED

CIC-14 REPORT COLLECTION
REPRODUCTION
COPY

PUBLICLY RELEASABLE
LANL Classification Group
J. Seybolt 4/18/96

LA REPORT-233

c.3

March 1, 1945

This document contains 16 pages

HOT PRESSING OF SOLID PLUTONIUM HEMISPHERES

WORK DONE BY:

2/3 L. Levinson

A. Seybolt

J. Taub

REPORT WRITTEN BY:

A. Seybolt

J. Taub

Classification changed to UNCLASSIFIED
by authority of the U. S. Atomic Energy Commission.

Per ALDR(TID-1400-S2)Sept-Oct 1974

By REPORT LIBRARY *Pete Martiney 1/29/75*

VERIFIED UNCLASSIFIED

Per *LMR 6-11-79*

By *M. Balogus 7-18-96*

VERIFIED UNCLASSIFIED

LMR - 6-11-79

6 MS - 11-15-78

LOS ALAMOS NATL LAB LIBS
3 9338 00407 9298

...in the United States within the mean-
ing of the Espionage Act U.S.C. 50... its
transmission or the revelation of its contents in any
... prohibited by law.

UNCLASSIFIED

UNCLASSIFIED
UNCLASSIFIED

UNCLASSIFIED

ABSTRACT

A description is given of the production of the .90" diameter plutonium hemispheres used for the start of the plutonium neutron multiplication experiments to be performed by group R-2. Cast slugs of metal were hot pressed at 250°C in a steel die in vacuum. Heating and cooling data obtained during pressing, and final dimensions and measured densities of the two hemispheres are given. After fabrication, the two hemispheres were given a 2 mil silver electroplated coating for ease in handling.

UNCLASSIFIED

UNCLASSIFIED
UNCLASSIFIED

UNCLASSIFIED

SECRET

[REDACTED]

HOT PRESSING OF SOLID PLUTONIUM HEMISPHERES

Introduction

The purpose of the work subsequently described in this report was to form solid hemispheres from cast slugs of plutonium for the neutron multiplication experiments. The forming of plutonium metal presented several interesting problems, foremost among them being the determination of the pressures necessary for complete forming in a closed die, the prevention of oxidation at the forming temperature, and the development of a safe working practice.

Group CM-8 obtained preliminary results on forming pressures for plutonium metal, these results being of considerable aid in the forming work performed by CM-11. They reported that hot pressing plutonium at 250°C with a pressure of about 25,000 p.s.i. gave satisfactory results when the metal was cooled under pressure to room temperature. This last precaution was necessary to avoid distortion of the piece during the transformation from beta or gamma plutonium to room-temperature-stable alpha. As it developed, even this procedure did not prevent all distortion because apparently some transformation occurred after removal of the pieces from the die. An investigation was also carried out by this group to find a metal having flow characteristics similar to plutonium at the necessary forming temperature, to be used as a stand-in for establishing the forming technique. Annealed aluminum (2S) was found to be suitable for this purpose, the pressure and temperature required to flow the metal into the sharp corners of the die being approximately the same as required for plutonium.

The problems of oxidation at the forming temperature and safe working practices were handled in a different manner from CM-8, which worked with hot oil. A vacuum system was used for forming the metal, while the usual dry box was employed for protection of the operator in handling the material, when loading or unloading the dies.

SECRET

[REDACTED]

SECRET
 CONFIDENTIAL

The following report describes the procedure and results of the preliminary forming of 2S aluminum and the final forming of the solid plutonium hemispheres.

MATERIAL, EQUIPMENT AND PROCEDURE

Material

All preliminary work was performed on slugs machined from cold drawn 2S aluminum rod, and subsequently annealed. The plutonium metal was received from CM-8 in the form of cast slugs approximately 0.8 inch in diameter and 0.5 inch high and possessing a rounded bottom and an uneven top.

Equipment

The pressing was performed on a 75 ton Hannifin Hydraulic press, possessing controls whereby a constant load could be maintained.

All handling of the material, in transferring from container to die and from die to container was carried out in a dry box used only for plutonium work. A pump was connected to the dry box in order to maintain a negative pressure in it and prevent leakage from the interior of the box to the atmosphere. A pipe filled with oil-soaked glass wool was fastened to the exhaust of the vacuum pump in order to catch any material drawn out of the dry box. The box contained a hot plate for heating purposes and also held the tools necessary to separate the punch and die after the forming operation.

The pressing was performed within an evacuated 9 inch diameter cylindrical brass container. The sides of the brass shell carried fittings for electrical, water and thermocouple connection, and a one inch pipe leading to the vacuum pumps, see Fig. 1. The purpose of the bellows was to permit the necessary forming stroke.

SECRET
 CONFIDENTIAL

SECRET

SECRET

SECRET

The vacuum pumping system consisted of a National Research Corporation diffusion pump NH-2 connected in series with a Cenco Hypervac 20 vacuum pump.

Two sets of tools were made for the forming program. The first set consisted of a flat die and a flat punch which were held in alignment within a thick-walled sleeve, 3 inches OD and 1.25 inches ID. The same sleeve was available for both sets of tools. The second set of tools contained the actual shape desired and consisted of a die having a hemispherical bottom adjoining a cylindrical wall section. The punch fit into the cylindrical portion of the die and was ground flat except for the 8 mm hemisphere protruding from the center of the punch. Any flash formed in tools of this design would be parallel to the wall of the piece. Fig. 2 shows the two sets of tools employed. The punches possessed holes for thermocouples. All tools were made of K-26 tool steel. If the piece should stick in the die, a set screw could be removed from the bottom of the die, allowing a small plug to fall out, and the piece could be pushed out of the die with a small rod.

Temperature measurements were made with a Leeds and Northrup potentiometer and Chromel-Alumel thermocouples. Since the piece was to be cooled to room temperature under pressure, no allowance for contraction was made, and the tools were made to exact required size.

Procedure

Vacuum System The arrangement first used within the evacuated shell was somewhat different from that finally used. A hot plate containing a 1000-watt ring heater was the source of heat and the die was heated by conduction. The cooling plate was placed between the die and the hot plate so that both were cooled when circulating water was passed through the plate. Only one vacuum pump, a Cenco Megavac, was attached to the vacuum system. With this arrangement it was found to

SECRET

SECRET

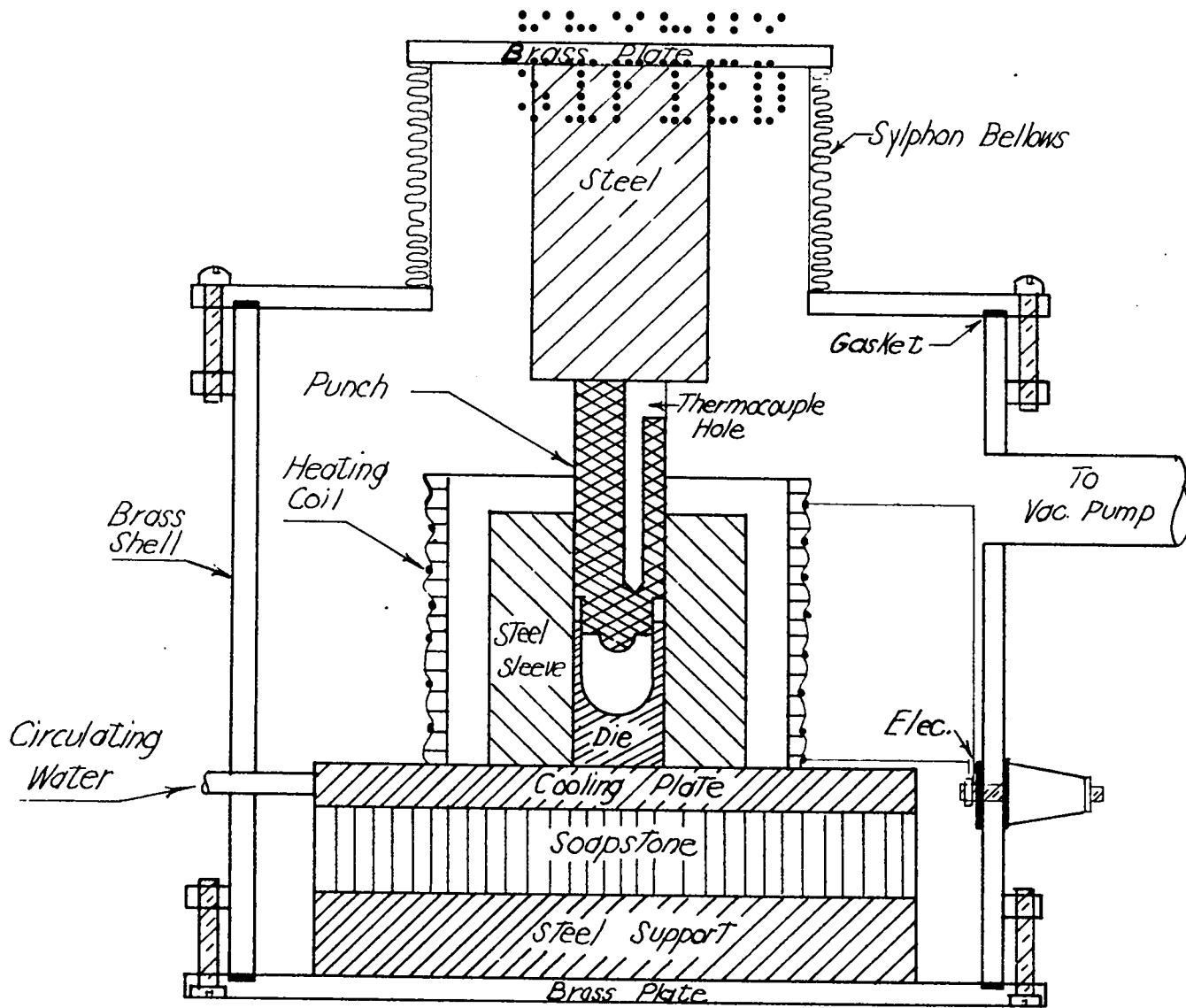

Fig. 1 Section Through Shell Assembly

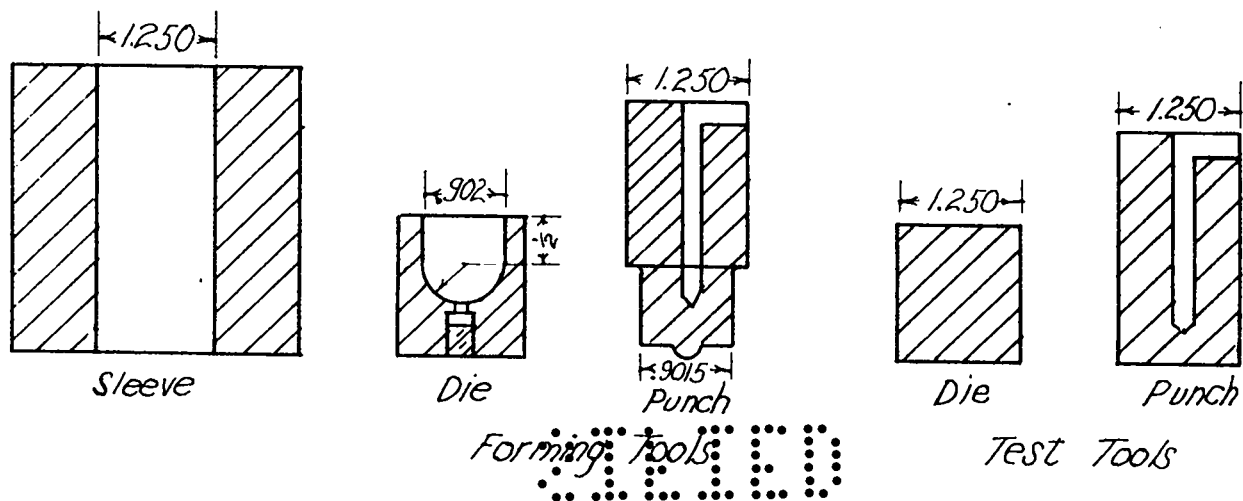

Fig. 2 Tools Employed in Forming Program

.

be extremely difficult to obtain a vacuum of less than 100 microns and after everything had been tested and found tight, it was decided to abandon the hot plate method of heating, for it was believed that some gases were coming from the materials of the ring heater. The resistance coil heater was then built, heating the tools by radiation. In addition, the above-mentioned NH-2 diffusion pump and a Hypervac vacuum pump were connected in series, and a vacuum reading of less than 0.5 microns was obtained and could be reproduced with each pressing. It was necessary to place aluminum foil around the inside of the shell as a radiation shield, for the shell became very hot due to radiation from the resistance heater.

Aluminum Pressing

Hot pressing experiments were started before the vacuum system was completely finished. The pressings were performed with the flat die and punch within the steel sleeve to determine the pressing force necessary to completely fill the die. The material tested was 2S aluminum blanks approximately 3/4 inch in diameter. The first pressing at 250°C, 10 tons load, was not very satisfactory, for the pressed piece possessed an elliptical shape and stuck to the die. Previous to the second pressing the tools were warmed and aquadag was applied. This pressing, also at 250°C and 10 tons load, was considerably better than the previous one, for no sticking occurred and the piece filled the die, the sides of the piece having a slight bulge instead of being straight. The third pressing at 288°C and 12 tons load filled the die completely. Aquadag was adopted as the standard lubricant and no further sticking occurred.

The next set of experiments was conducted in the evacuated shell using the hemispherical die and corresponding punch, and a 2S aluminum slug of approximately the same diameter as the cast 4S slug, the height of the slug being varied to

.

.

SECRET
SECRET

obtain the desired size hemisphere.

The first aluminum slug pressed weighed approximately 8 grams. The procedure in pressing was to first warm the tools and apply a coating of aquadag. The punch, slug and die were then assembled in the sleeve and the assembly placed in the shell, the cover screwed tightly in place and the vacuum pump and heating unit started. When the temperature reached 250°C a load of 8 tons was applied to the punch and this load held constant until the temperature had dropped to approximately 35°C. The procedure in cooling was to start circulating water through the cooling plate after the desired pressure on the punch had been reached, opening the exhaust from the cooling plate to the atmosphere until all of the steam had been removed and then quickly connecting the exhaust from the cooling plate to the exhaust of the circulating water system. The vacuum system continued to operate during the entire cooling cycle. When the temperature dropped to 35°C the top was removed and the die taken out of the shell.

The first aluminum slug was too small and did not completely bottom in the die. The next slug weighed 9.84 grams and was pressed by the same technique as described above. This weight was too much, for the pressed piece extended into the cylindrical portion of the die for a distance of .064 inches. The diameter of this piece at the parting line was .901 inches, and the surface appearance was excellent. The third slug weighed 8.723 grams and extended .025 inches into the cylindrical portion of the die. The diameter of the parting line was .898, the decrease in this dimension probably being caused by an increase in the thickness of graphite on the die surface. Both the second and third hemispheres stuck in the die and were released by submerging the die in liquid nitrogen, the differential shrinking action created by the difference in coefficients of expansion of the metals causing the aluminum to fall out of the die. The plug in the base of the

SECRET

UNCLASSIFIED

die would have worked just as well, but an alternate method of removing the hemisphere from the die was desired. The fourth slug weighed 8.449 grams and was pressed satisfactorily, the diameter at the parting line being .899 inches while the dimension in the perpendicular direction extended .014 inch into the cylindrical section of the die. The fifth slug weighed 8.243 grams and did not possess enough metal to fully bottom in the die.

The following table summarizes the results of the preliminary investigation on 2S aluminum material.

Table I

Hot Pressing of 2S Aluminum into Hemisphere

<u>Wt. of Slug, grams</u>	<u>Load, Tons</u>	<u>Dia. at Parting line, inches</u>	<u>Radius perpendic- ular to parting line, in.</u>	<u>Remarks</u>
8.0	8	-	-	Did not bottom in die
9.878	8	.901	.514	
8.723	8	.898	.475	
8.449	8	.899	.464	
8.243	8	-	-	Did not bottom in die

The results of the tests on aluminum indicated that it would be desirable to allow the hemisphere to extend approximately .010 inch into the cylindrical portion of the die, rather than have not enough metal present and cause the punch to bend in the die. A density measurement was performed on one aluminum slug, and

SECRET

SECRET

UNCLASSIFIED

UNCLASSIFIED

UNCLASSIFIED

with the data tabulated above the volume of metal necessary to obtain a certain size hemisphere could be calculated. From this information and knowing the density of plutonium, the weight of the slug necessary to form a hemisphere of plutonium of the desired size could be calculated. The weight of a perfect hemisphere of plutonium was calculated to be 58 gr. and a 60 gr. slug was desired which would add .010 inches to the height of the slug.

Pressing Plutonium Hemispheres

The die, punch and plutonium slug, weighing 60.364 grams, were assembled in the dry box, after aquadag had been applied to the tools, the assembly being taken out to the press and fitted into steel sleeve already positioned in the shell. The top was securely fastened to the shell and the vacuum pumps and heating unit started. At a temperature of 250°C a load of 8 tons was applied to the punch, and the circulating water was started through the cooling plate. When the temperature reached 34°C the die and punch assembly was removed to the dry box, forced apart with wedges and the plutonium hemisphere dropped out. The hemisphere was then turned over to Morris Kolodney for density measurements and electroplating. The original cast slug and the final hemisphere are shown in Fig. 3.

The second plutonium slug weighed 60.283 grams and was pressed in the same manner as the first slug. A vacuum of 1.0 micron and less inside the shell was obtained in both pressings. The heating and cooling data observed during the run are plotted in Figs. IV and V. Gallium was inserted in the thermocouple hole to obtain better thermal contact between die and thermocouple during the second pressing.

Safety was of prime importance in pressing the plutonium metal and all

UNCLASSIFIED

UNCLASSIFIED

UNCLASSIFIED

SECRET

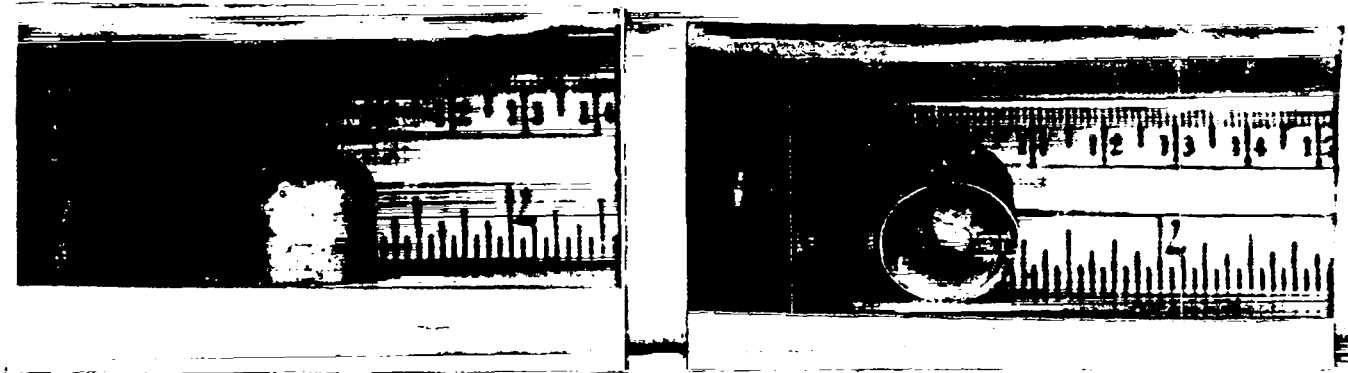
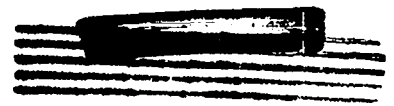

As received 49 cast slug

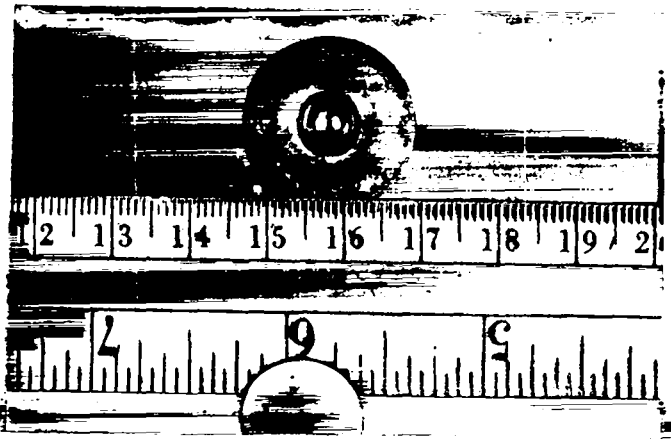
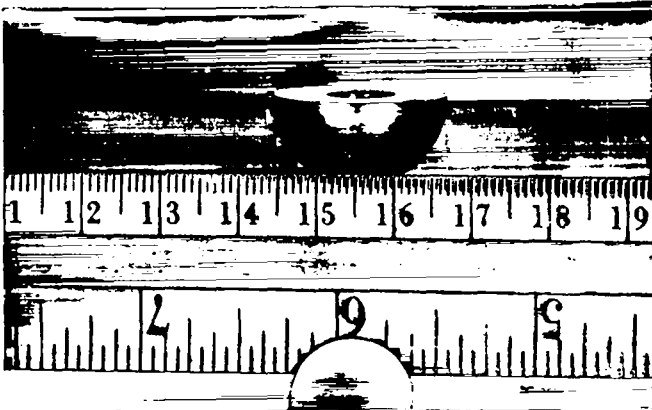

Hot pressed 49 hemisphere

Fig. 3 Photographs of original and final pieces

UNCLASSIFIED

SECRET

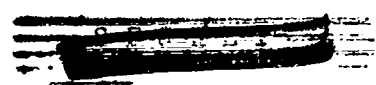

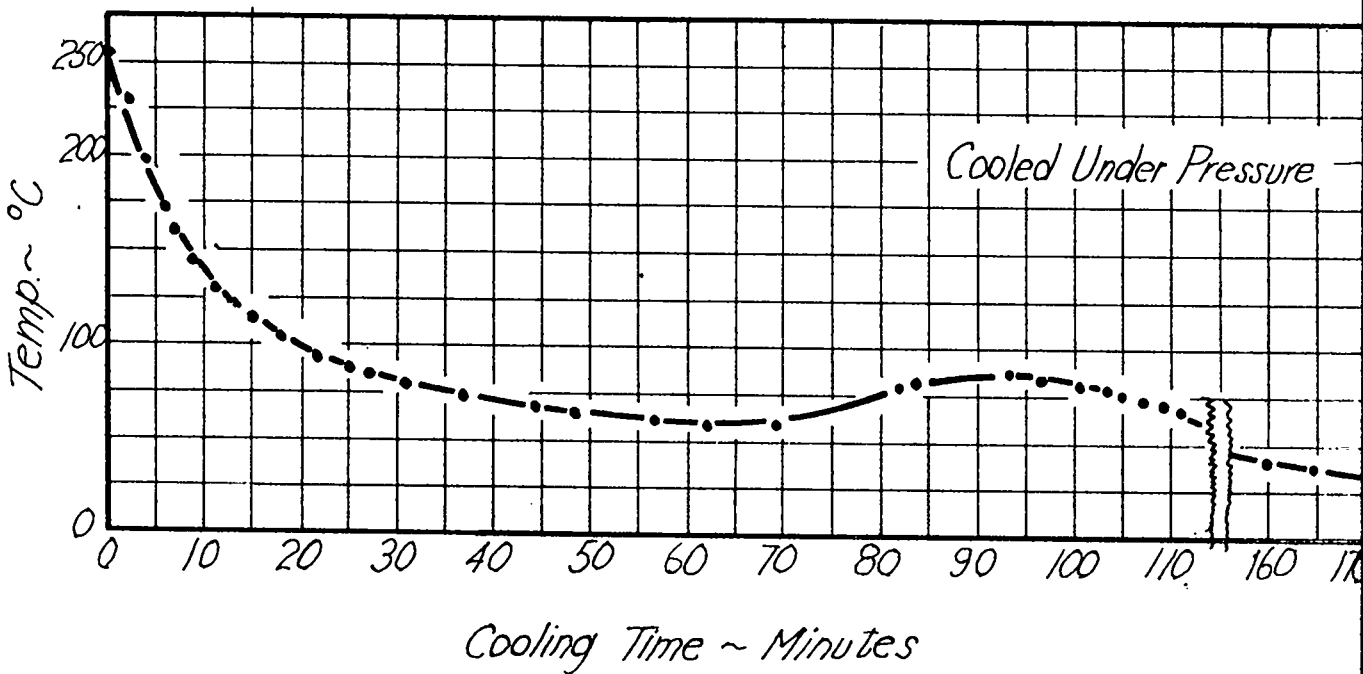
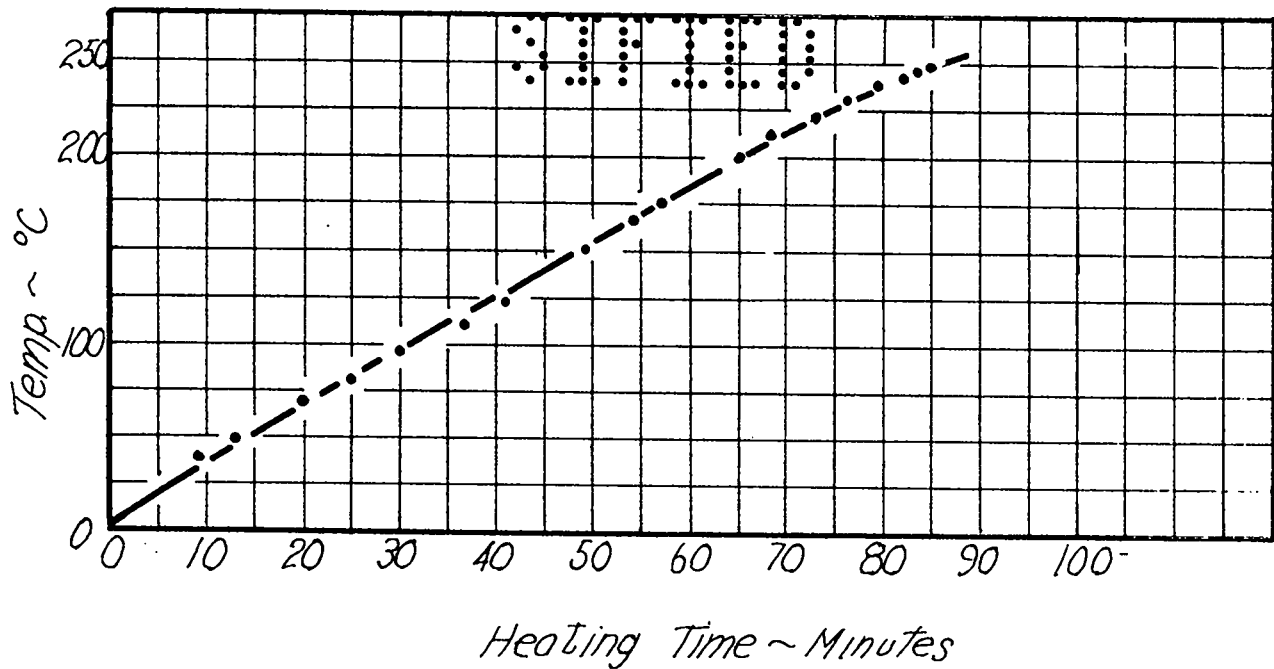

Fig. 4 Heating and Cooling Curves for First
49 Hemisphere Pressing

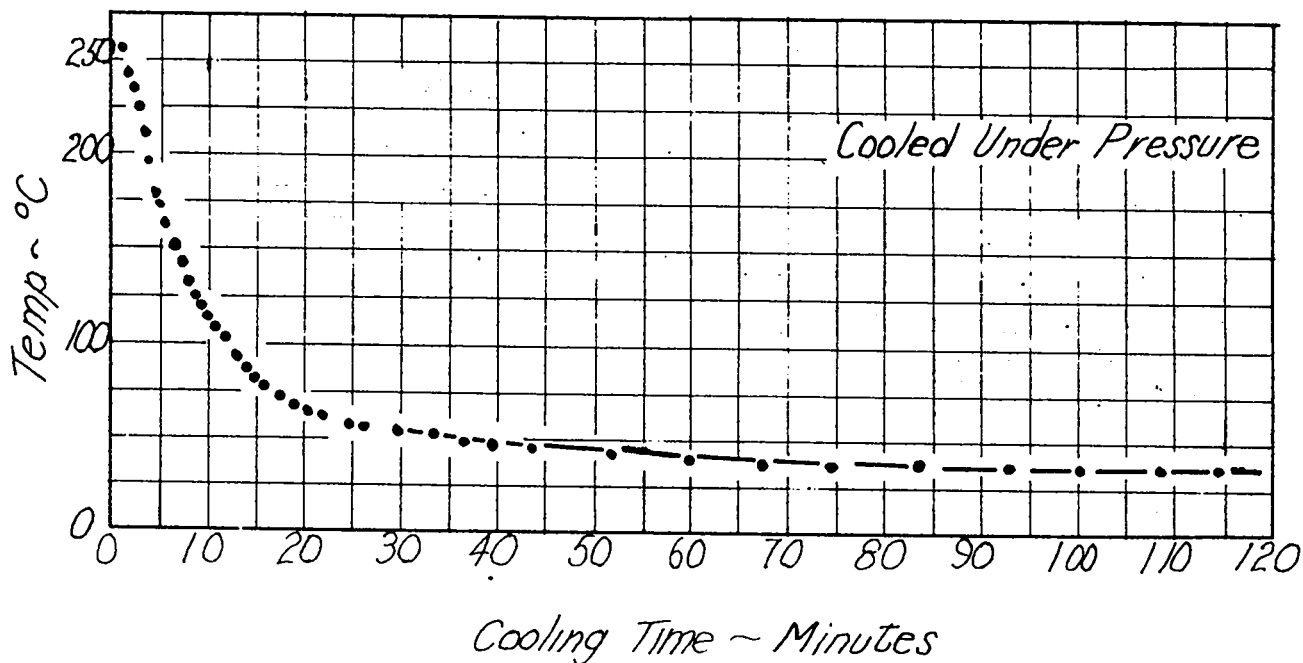
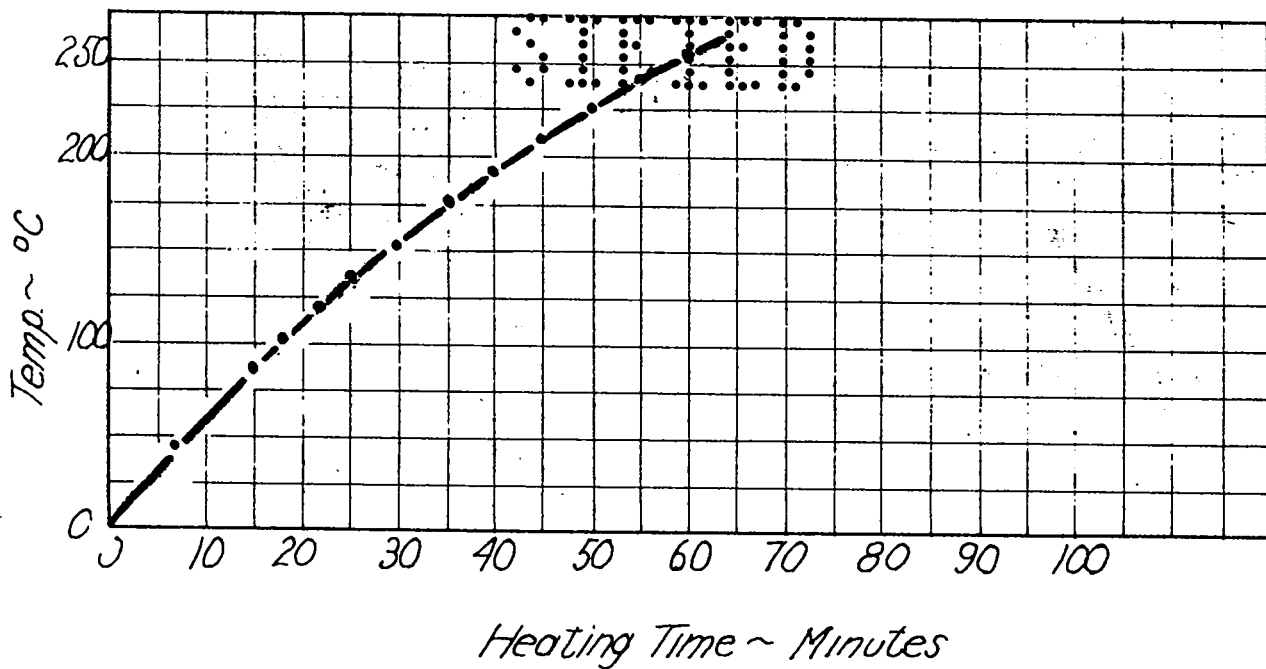
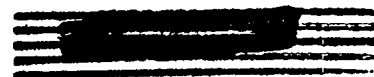

Fig. 5 Heating and Cooling Curves for Second
49 Hemisphere Pressing

U. S. GOVERNMENT
 PRINTING OFFICE



possible precautions were observed in making the pressing.

Results

The information obtained from the aluminum pressings enabled a suitable technique to be established for hot pressing in a vacuum. From the data the desired amount of plutonium metal could be calculated to yield a hemisphere of the proper dimensions.

A peculiar phenomenon was witnessed upon cooling the first plutonium pressing. When the temperature had fallen to approximately 60°C, as indicated by the potentiometer, a rise in temperature was observed to take place, Fig. 4, the temperature rising to a maximum of 90°C. One hour of cooling time was lost because of this phenomenon. Within the same temperature range, also, an increase in load was observed on the press. The piece had been pressed and was cooling under a load of 8 tons, and near the end of the cooling range the pressure rose slowly until a load of 12 tons was observed on the gage. No correlation between the two phenomena was made at the time, for the rise in temperature was attributed to some change in the thermocouple position, whereas the change in load was believed to be a peculiar function of the press operation. The hemisphere was at room temperature when removed from the die and the diameter at the parting line was .899 inches while the height was .460 inches as calculated. The density of the final piece was 19.55 and the weight was 60.354 grams. It is now thought possible that the rise in temperature on cooling was due to the transformation from the beta to the alpha stage, although we know of no satisfactory explanation to account for the change in pressure.

When the second plutonium slug was pressed the thermocouple hole was filled with Gallium to insure proper thermal contact. In this pressing the tools

U. S. GOVERNMENT
 PRINTING OFFICE

UNCLASSIFIED

U. S. GOVERNMENT
 PRINTING OFFICE

SECRET
SECRET

reached the forming temperature 25 minutes earlier than in the first pressing, Fig. 5, suggesting that the thermocouple in the first pressing may not have been in good conduct with the punch. No phenomenon similar to that observed in the first pressing was noticed on the second pressing. The one discrepancy noted in this case however, was that the temperature of the die and piece when actually removed from the shell was definitely higher than the 34°C indicated on the potentiometer. It is believed that the transition point from beta to alpha may have started just as the piece was being removed, and the same temperature phenomenon as before would perhaps have been observed again if it had remained in the die under pressure. The dimensions of the second piece were .897 inches at the parting line diameter and .460 inches high. The density of this piece was 19.59 and the final weight was 60.27 grams.

It was observed after a period of 24 hours or longer, that some warpage had occurred of the flat, top surface of the hemispheres. One piece warped to produce a concave surface while the second piece had a convex surface, the deflection from the flat surface being perhaps about .005 inch. Fortunately, the fit of the two hemispheres after warpage was satisfactory.

More work is necessary to determine conditions under which the transformation will be complete in the die and not cause warpage afterwards.

The equipment used was tested by the health group for alpha counts, and after the first pressing the maximum count was 200 on the inside of the sleeve containing the punch and die. A count of 80 was recorded on the wall of the shell while a count of 0 was obtained on the exhaust from the vacuum pump. After the second pressing the count on the inside of the sleeve containing the punch and die had risen to 360, while the maximum count was 80 on all other parts tested.

SECRET

UNCLASSIFIED

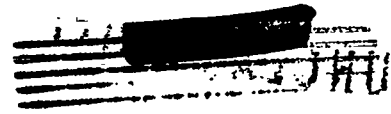

Conclusions

The results of the work described in this report have indicated that by employing good forming technique, obtained by forming similar shapes from stand-in metal, and by exercising extreme care in processing the material, plutonium metal may be successfully formed into desired parts, without seriously endangering the health of the operators.

In hot forming the metal, however, considerable care should be taken to maintain the metal under pressure until the low temperature transition point has definitely been passed. If high dimensional accuracy is needed, and if low density is not objectionable, it would be preferable to stabilize the metal in a high temperature modification by alloying in order to eliminate changes in dimensions due to transformations.

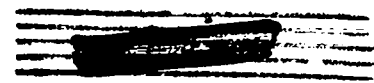

UNCLASSIFIED

SECRET

SECRET

UNCLASSIFIED

03715
03715

DOCUMENT ROOM

REC. FROM CO

DATE 3/6/45

REC. NO. REC.

UNCLASSIFIED

03715
03715