

LAMS-1684

Copy 1 of 25

Series A

LOS ALAMOS NATIONAL LABORATORY



3 9338 00371 9142



UNCLASSIFIED

LOS ALAMOS SCIENTIFIC LABORATORY
of the
UNIVERSITY OF CALIFORNIA

Report written:
June 1954

VERIFIED UNCLASSIFIED

PUBLICLY RELEASABLE

Per LMR 6/20/79
By Jamyado Deb 11/13/95

Per M JAIN, FSS-16 Date: 10/13/95
By Jamyado Deb, CIC-14 Date: 11/13/95

LAMS-1684 This document consists of 41 pages,
[REDACTED] es, Series A

PIN CONTACTOR METHOD

by
B. L. Burton

INSTRUMENTATION

All Los Alamos reports are the property of the Laboratory and do not necessarily reflect the views of the Los Alamos Laboratory. Furthermore, this LAMS report has not been prepared for distribution. It is requested that no distribution be made without the permission of the Director's Office of the Laboratory.

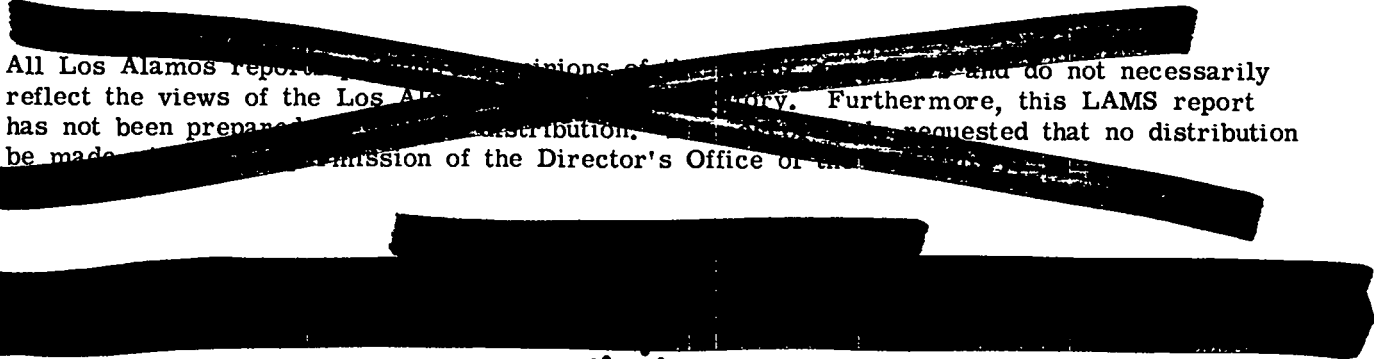

UNCLASSIFIED



3 9338 00371 9142

 UNCLASSIFIED

INSTRUMENTATION

Report distributed AUG 5 1954

LAMS-1684

Los Alamos Report Library

1-25

UNCLASSIFIED

 UNCLASSIFIED
APPROVED FOR PUBLIC RELEASE

This report is intended to cover the evolution of the so-called pin contactor method used in the investigation of properties of substances deducible from measurements of velocities in and of the material. It will be restricted to work done at Los Alamos, although some work has been done in other places. Most of the material in this report will deal specifically with work done by Group GMX-4. It is hoped that proper credit will be given to the early workers using this method although undoubtedly some will not be mentioned individually by name. The report is divided into several sections, with the first being a very short historical survey, the next, a general discussion of the pin technique as a whole, followed by an examination of the several types of pins which have been and are presently being used, a description of the electronic equipment, the type of record obtained and its analysis, and the accuracy of the method.

HISTORY

One of the earliest references to the electrical contact method is a report written by Froman dated December 7, 1944. This gives credit to work done by Benzon, Fisk, Froman, Graves, Ludwig, Marshall, Nedzel, Pennypacker, Roberts, Van Lyssel, Waiter and Wechsler. Essentially this report describes a method of investigating the motion of one surface of a metallic wall of any shape propelled by the detonation of a charge of high explosive in contact with the other surface of the wall. The method then, as now, consists in recording the time of contact of the wall with wires, "pins", placed normal to the surface with their ends at an accurately known distance from the original position of the surface. The record of

UNCLASSIFIED

UNCLASSIFIED

CLASSIFIED

the experiment is a photograph of an oscilloscope trace having pulses occurring at pin contact and having also some form of timing markers. The signals from several pins may appear on one trace, the number being determined by the necessity of distinguishing the pulses on the photographic record, with the various contacts identified by the sign, magnitude, and shape of the voltage pulse. The results can then be plotted as points on a curve of displacement vs. time for the surface. From such a record, then, the velocity with which the free surface of the material moves may be obtained. A similar type of procedure may be used to determine the arrival of a shock wave in the metal plate at predetermined positions. This will be discussed more thoroughly later.

On May 19, 1945, Goranson wrote a memorandum in which he mentions the use of the pin contactor method, developed at Norfolk and somewhat similar to Froman's pin method, to measure material velocity (using H.E.).

Froman and Graves wrote two reports in July of 1945. In these reports they discussed possible errors in the pin method of velocity measurement and the use of this method in measuring material velocity, transit times, and symmetry. In addition a critical survey was made to evaluate the results of possible errors in pin position and in time measurements. Some experimental measurements were also compared with theoretical calculations, the discrepancies being explained as probably a result of non-uniformity of H.E. charges.

UNCLASSIFIED

On 13 June 1946 a memorandum was written by D. Bancroft to D. K. Froman on the Measurement of Surface Velocities. In this memorandum Bancroft discusses ways of exploiting the pin method by reducing the resolving time to a minimum. A way is discussed for measuring contact spacing to ± 0.0001 ". Electronic networks and coaxial cables are discussed briefly, as is also the matter of potential on the pins. At that time the principal difficulty encountered was in establishing when the moving surface actually completed the electrical circuit. The observed results could be explained on the assumption that about $0.1 \mu\text{sec}$ was necessary for the resistance to change from 1000 to 10 ohms.

This effect was first blamed on ionized gas and an improvement was noted when the pins were insulated in such a way that a metallic impact was necessary in order to destroy the insulation. This was effective at low velocities but failed at higher velocities. Evacuating the system to about 10^{-4} mm of mercury was tried next and gave considerable improvement.

It was also noted at about that time that brass pins did not give as good results as steel pins of about two-thirds the diameter. A further improvement was achieved by placing the pins in a larger pin circle, 0.4" diameter instead of 0.2" used previously. The improvement was ascribed to lessening the perturbation effect. It was inferred that the first pin to make contact caused other pins to discharge prematurely. It was concluded that if the spacing between pins was greater than five times the pin diameter, no perturbation effects would be noted.

UNCLASSIFIED

A pin arrangement in a circle with eight pins was then used. This was very similar to current arrangements. Errors in velocity determination caused by a plane tilt of the shock wave were eliminated by placing each pin diametrically opposite its immediate predecessor. A pin at the center of the circle provided a signal to trip the oscilloscope. The arrangement was as follows:

- 1.
5. .3
8. .7
4. .6
- 2.

Successive numbers refer to increased pin position spacing.

In a memorandum to Froman dated July 3, 1946 Bancroft discussed the use of simultaneous measurements of shock and particle velocity in the determination of pressure and density behind a shock wave. A suggestion is made how it might be possible, in the plane wave case, to obtain additional information about the sound velocity in the compressed material.

No further early work will be mentioned in detail. However a few more reports do exist on various phases of the pin technique and some developments might be traced through division and group progress reports. Further discussion of individual work appears later in the appropriate section.

GENERAL DESCRIPTION OF SET-UP

Various arrangements have been used in the past for so-called "plate shots" for a question of state investigations by the pin method.

UNCLASSIFIED

However a few remarks may be made that apply fairly generally to such shots. They have, to a greater or lesser degree, the following features. In general a detonator, an explosive plane wave lens, and a pad of some explosive, such as Baratol or Composition B, make up the explosive system. Sufficient explosive is used in the pad to insure a stable shock in the material on which measurements are to be made. This in general means at least a thickness of 2" although in many or perhaps in most cases the thickness is likely to be about 4".

The explosive assembly is placed in contact with the shot proper. This consists of the material under test which is usually a metal. In this metal plate, which may be either circular or square and of a size about 4" to 9" in diameter and 1/4" to 2" thick, an array of pins is either inserted into drilled holes or mounted behind the plate depending on whether shock velocity or free surface velocity is to be measured. If free surface measurements are to be made, sometimes it is essential that the pins be in an atmosphere of a gas like methane in order to obtain acceptable records.

These pins are customarily mounted rigidly to something other than the plate under test. This may well be a piece of textolite or other insulating material.

The pins in the plate are connected to an electrical network which provides a charging potential on the pins and which produces a pulse on a coaxial cable when the pins are discharged. The size and shape of the pulse can be regulated by proper choice of capacity and resistance in the electrical network. The coaxial cables lead from the shot back to the recording equipment in a control room. This

UNCLASSIFIED

UNCLASSIFIED

recording equipment consists of cathode ray oscilloscopes so synchronized that these pulses are displayed on the screen. Timing markers may be put on the shot record or on a separate sweep slightly displaced from this shot record. If separate shot and timing sweeps are used, the timing sweeps are made either preceding or following the shot record by a few seconds. The oscilloscope trace is photographed on a 4" x 5" film plate which is then used to determine the arrival time at the various pin positions. Records obtained from several oscilloscopes may be related one to another by common pulses. Positive identification of common pulses, frequently called fiducials, requires a distinctive shape or size or both.

EVOLUTION OF CONTACTOR

Shock Pins

Pins for Conducting Material

The three main problems in this type of work are the determination of the position of the end of the pins, the prevention of premature shorting of the pin, and the insurance of a clean, rapid short when the shock wave strikes the pin. In any method of determining shock pin position, the first step consists in measuring the depth of the pin hole. Early workers proceeded by either dropping a disk of mica or cellophane ranging in thickness from 1/2 mil to 5 mils in the hole and jamming the pin down on top of it, or by putting the pin down until it just made electrical contact with the bottom of the hole and then backing the pin off a predetermined amount by means of some screw arrangement. To prevent the sides of the pin from shorting to the sides of the hole, pieces

UNCLASSIFIED

of ceramic tubing around the pin were first used. From this there evolved the composite pin. Tungsten or Kovar wires are inserted in small glass tubes and sealed in place with one end protruding enough that an electrical lead can be soldered on. At the other end which is to be inserted into a drilled hole the glass extends a few mils beyond the end of the wire. If the hole bottom is flat and clean, the glass sleeve serves to fix accurately the separation of pin end and hole bottom. Another useful pin consists of a metal wire coated with glyptal. The hole end of this pin is machined flat and spacing from the bottom of the hole is obtained by insertion of a number of very small glass beads. Since the diameters of the beads are not accurately known, it is necessary to determine the distance from pin end to hole bottom by measurements on the hole before insertion and on the pin before and after insertion.

Summary of Types of Pins

1. Piano wire with set screw.

As a subtype of this pin, a ceramic tube glued in the hole with a mica or cellophane disk at the bottom has been used. When the set screw was tightened, the pin often punctured the soft mica. It was very difficult then to remove the ceramic tube and replace the insulation.

2. Same general type of pin as above but with a drilled 2-56 screw instead of a set screw. This was slightly better.

3. A 2-56 screw with flat-ended 20 mil piano wire soldered in it.

This type of pin was used in the following ways:

- a. Inserted into a ceramic tube glued in the hole with an insulating disk at the bottom.

- b. Inserted into ceramic tube glued in the hole with the pin backed off some predetermined fraction of a turn.

UNCLASSIFIED

c. A thin sleeve of insulation pushed over the pin, a 1 mil mica disk dropped into the hole, and the pin tightened down on top of the disk. This seems to be the best type of shock pin yet developed which depends on an insulating disk. Any shorts occurring with this type are very easy to correct.

4. Prefabricated Pins.

a. Piano wire glued inside ceramic tubing with the end ground off flat, a mica or cellophane disk glued on, and the entire assembly glued into the hole. With this type there was no good way of knowing whether the pin was at the bottom of the hole and no way of correcting for a short.

b. The composite glass and Kovar pins of various diameters and setback, which were first held in place with ferrule cement and later held in place with springs. These were occasionally used with cellophane disks under the pin but this seemed to be undesirable. It has been found by experience that pins with 3 mil setback are best. The effective setback was difficult to measure due to the condition of the end of the glass and of the Kovar. This difficulty in commercially obtained pins is probably not inherent in the type of pin.

c. A 65 mil dural wire coated with several layers of glyptal. These pins had the end machined flat and polished.

The preceding pins were all intended for insertion into a flat-bottomed, drilled hole. Another method of measuring shock velocities consisted in the use of a series of machined steps in a metal plate with pins on these steps. This method had the virtue of enabling one to see what was being done but the method required a large amount of space. However it is

UNCLASSIFIED

UNCLASSIFIED

true that with this method almost any flat or round-ended free surface or shock pin could be used, as can be seen from the following list.

5. a. 20 mil or 11 mil piano wire soldered into drilled 2-56 screws and set against 1/2 mil of mica. This type of pin is convenient and simple with a short break-through time.

b. Flat ended 6-32 screws set on 1 mil mica or cellophane.

c. Flat ended screws set tightly against a 1/4" cube of dural which in turn is set on a piece of mica or cellophane.

d. Flat ended pins consisting of 26 mil piano wire with a 2-56 set screw or 11 mil wire with 0-80 set screws jammed on to a fairly thick disk. This type of pin was very poor as positioning of pins by set screws is poor in general.

6. Tacks. A small, flat-headed, metal tack was up-ended on a piece of cellophane and the two were fastened to the plate with ferrule cement. This seemed to be a very poor method leading to break-through times varying by much as 3/4 μ sec at low pressures.

7. "Baby Top Hats".

This type of pin made use of a top-hat shaped insulator which was set on its brim and stuck on with ferrule cement. After the cement had hardened, a tiny round-ended screw was run down through the top of the hat until it made electrical contact with the plate and then backed off a predetermined distance. This is an excellent pin but it is very delicate and extreme care must be taken to see that it is not loosened when the lead is soldered to the pin. Armstrong cement is now used, and that seems to be better in that it is not loosened when the lead is soldered to the pin.

UNCLASSIFIED

All the shock pins listed above are for use with conducting materials. To adapt them for use with non-conductors it is necessary to provide a strip of grounded foil which the shock wave can short to the pin.

8. A conventional shock pin with a narrow strip of thin copper foil across the end of the pin. The pins used in this way were those mentioned in 4 a and 4 b above. There was difficulty with glass and Kovar pins having setbacks as large as 5 mils apparently due to the foil tearing before it contacted the pin. In the most recent version silver foil 1 mil thick is used, with very satisfactory results.

9. 2-56 screws with a piece of 11 mil wire soldered on the end. This wire was then insulated with radio cement and a grounded copper jacket slipped over the pin. This method has been found useful for experiments with liquids.

10. Inverted Steps. A stepped metal block is used which has shock pin holes drilled to within a few mils of the stepped surface which faces the explosive and matches accurately the stepped block of the non-conductor. With this any desired type of shock pin can be used.

Discharge of Pins by Shock Wave in Gas.

Whenever a plate is driven into a gas a shock wave in the gas will move ahead of the surface of the plate. The pressure in the gas shock wave is determined by the velocity of the plate. If the velocity is sufficiently high, the gas shock front becomes conducting and will cause early discharge of free surface pins. This phenomena causes trouble when the velocity exceeds 2.5 mm/ μ sec if the plate is driven into air at atmospheric pressure. Methane shock fronts are not conducting at any

velocities easily obtained. It is now suspected that the critical velocity for this gas is somewhere between 12 and 15 mm/ μ sec. It is now common practice to provide an atmosphere of methane for free surface pins. If this is inconvenient, other techniques may be used.

If a plate is coated with kerosene or other thin oil, the kerosene or oil seems to quench the ionization and permits measurements in air at somewhat higher velocities than would be possible without the coating. This remedy seems to be effective only if the distance from plate to pin is less than about 8 mm. If the pin distance is less than about 2 mm an insulating disc glued to the end of the pin seems to be effective.

1. A pin similar to that mentioned in 9 above may be used to prevent predischage. It is used chiefly where gas or kerosene would be objectionable, such as a shot in which it is desired to measure both air shock and free surface velocity.

2. A pin similar to that just described, but with the end of the shield left open and the tip of the pin not insulated, was intended to be used as a sensitive detector of the conducting layer associated with an air shock. This however has been found to be of little use.

Free Surface Pins (No provision for protection from premature discharge.)

In general these pins are held above the metal surface by being mounted in a separate plate of an insulating material such as textolite. This plate is rigidly fastened to the metal, standing above it on spacers.

1. 26 mil piano wire pushed through a bakelite holder.

This type of pin is used only for rough shots to test the oscilloscopes.

2. 26 mil piano wire with a 2-56 set screw and 11 mil wire with 0-80 set screw.

In this type, flat, rounded, pointed, and beveled pins were used at different times. Many crude free surface measurements over a 1-inch base line were made with these pins. The inconvenience caused by the pins moving up and down as the screws were tightened finally lead to the abandonment of this method.

3. 20 mil or 11 mil piano wire soldered in axially drilled 2-56 screws.

Rounded, pointed or beveled ends were used with this type of pin. However flat ends were impractical in that they could not easily be set parallel to the plate. It was found that the 20 mil wire seems to work much better than the 11 mil. If enough care is taken in tapping the holes in a bakelite holder and in straightening the pins, this is a fairly good method of setting free surface pins with base lines between 1/2" and 2". It is the most convenient method for making rough test shots.

4. Piano wire soldered in drilled, 0-80 screws set in a top hat.

This method is suitable for base lines of about 2 mm. The tapping and soldering must be done with great care if pin motion is to be avoided since it is very easy to soften the lucite hat.

5. A method in which use was made of 1/16" or 1/8" rods of steel or brass pointed to various angles and held in place by set screws was never very popular.

Although this is primarily an interface velocity pin it can also be used to obtain the velocity of the free surface. The use of set

screws on these rigid pins is not objectionable and the position of the end of the pin is easily determined.

6. 2-56 or smaller screws ground to either a point or a round end.

Generally 2-56 screws were used with pointed end and 0-80 with a round one. These methods are suitable for very short base line records.

7. Plastic Buttons.

Straight pieces of piano wire located in a suitable array and a plastic button cast around them. This was strictly a mass production method.

8. Force Fit.

A metal sleeve crimped on the end of a piece of 11 mil piano wire and the sleeve then force fitted into the textolite plate. The main virtue of this method is that a large number of pins differing greatly in length can be set in a small area. Round end pins are always used and each pin must be straightened after it is set.

9. 20 or 11 mil piano wire soldered into drilled 2-56 screws as mentioned earlier except that for this method 2-56 nuts were inserted into the insulating holder in order to eliminate the necessity for tapping the holes.

10. This method is the same as 6 above except that part of the screw is turned down to approximate a wire so that less of the threaded portion remains to be turned through the tapped hole.

Interface Pins

These are adaptations of free surface pins designed to measure the velocity of the interface between a conducting material driving a non-conducting one. Since the pin is set in a non-conductor, it will move

somewhat before the interface reaches the pin. This motion can be reduced by using a pin whose ρD (density-shock velocity) product is large compared to that of the non-conductor. If the pin is of small diameter and is in intimate contact with the non-conductor, one can assume that the pressure on it is approximately equal to that of the non-conductor if the condition (ρD large) is fulfilled. A correction factor can then be applied to compensate for the motion of the pin.

1. 20 mil piano wire soldered in drilled 2-56 screws.

This type of pin gave excellent results with liquids and very soft material. A few pins were made from tungsten wire instead of steel.

2. Sharply pointed steel or tungsten rods held in place with set screws. The usual diameter was $1/16$ " but everything from $1/32$ " to $1/8$ " was tried. This is suitable for rigid material if the pins are fitted tightly in their holes. A few shots to test pin motion had pins made of everything available from aluminum to tungsten.

Methods of Holding Pins in Place.

1. Set screws.

The pin is passed through a small hole in a plastic holder and secured by means of a set screw. The objections to this method are that the set screw will raise or lower the pin if the axis of the two holes do not coincide, that it will bend the pin if the small hole is not snug, and that it is necessary to clean the threads of the tapped hole very carefully or the plastic dust will prevent the screw from tightening on the pin. This method is fairly good for pins made of stiff rods but thoroughly unsatisfactory for piano wire.

2. Drilled Screws.

2-56 or 0-80 screws have small holes drilled in the end in which pieces of 11 or 20 mil piano wire are inserted and soldered in place. Tapped holes in a strip of plastic or a small top hat hold the pins in place. Some of the objections to this method are that the tapping of the holes in the pin holder is critical, with a loose hole giving rise to a wobbly pin, and a tight one requiring so much force to put the screw in place that the pin holder is deformed. The holes in the screws are never truly axial so that the wires emerge at odd angles. The lateral position of long pins is always in doubt. This method works well with the top hats and 0-80 screws. If care is taken in tapping the holes, and if the piano wires are kept fairly short, it is a fast and convenient method of setting free surface pins. It is probably the best shock pin method in which mica disks are used as insulators.

3. Pointed Screws.

This is similar to method 2 but the screw itself is ground to a point and used as the pin. This eliminates the difficulties in positioning but causes more trouble with tapping unless the pins are very short. It is a good method for setbacks, but impractical on a long base line shot.

4. Plastic Buttons.

Straight pieces of piano wire are located in a suitable array and a plastic button cast around them. This is strictly a mass production method.

5. Glue or Cement.

Various types of shock pins are glued or cemented in holes

either by spreading glue on the side of the pin or by using ferrule or Armstrong cement where the pin emerges from the hole. It is extremely difficult to correct a shorted pin and the shots are somewhat fragile. The main advantage is that the pins can be set very close together.

6. Springs.

In this method shock pins are held in place by a spring. This is secure and accurate but requires a lot of space.

7. Friction Fit.

A piece of piano wire (about 26 mils) is pushed through a tight hole and held in place by friction. This is very unsatisfactory.

8. A Useable Force-fit Method.

A metal sleeve is crimped on the end of a piece of 11 mil piano wire and the sleeve is then force-fitted in a hole drilled into the pin holder. There is the usual trouble about bending, but it is usually possible to straighten the pins by hand after they have been set. The method is very good for free surface pins which are several inches long.

9. Rubber Washer.

The pin is held in place by a rubber washer which is squeezed tight by a hollow screw through which the pin passes. Shorts are easily corrected. The method is accurate and does not require excessive space.

MEASUREMENT OF PIN POSITION

The position of pins in a shot is determined in various ways. For shock velocity measurements, the depth of the holes may be measured by depth micrometers or dial gauge, taking readings on the surface of the

[REDACTED]

plate and then on the top of a rod of known length inserted in the hole. Insulating material of known thickness can then be placed in the hole and the pin placed on this. One then may assume that the position of the end of the pin is known. This will of course be incorrect if the insulating layer is not of the correct thickness, if dirt gets into the hole beneath the pin, or if the pin, due to irregularities in the walls of its hole or its own surface, does not go all the way in and seat itself properly. To make sure that this does not happen, it is customary on important shots to make measurements of the length of each pin, and by measurement on the plates and on the top of the pin after it has been inserted in position, check that the end of the pin is at the proper depth.

To make this determination of pin locations easier and more accurate, a procedure has recently been devised which works very well. Hole depths are still determined individually, but adjustment of the positions of the individual shock pins has been eliminated. In the new design the shot assembly is constructed with an extra plate set on the shock plate. This pin plate is equipped with adjusting screws so it can be moved away from the shock plate, and has a set of tapped holes aligned with the shock pin holes in the main plate. Hollow studs are screwed into these holes and locked in place. The insulated shock pins are then inserted through the studs, checked electrically to make sure that they are in contact with the bottom of the shock pin holes and are finally cemented in place with a polymerizable resin cement. The pin plate, to which the pins are now fastened, is then raised 3 mils from the shock plate by means of the adjusting screws, drawing all the shock

pins up from the bottoms of their holes by exactly the same amount.

A sketch of this design is shown as Fig. 11.

PIN NETWORKS

The principle of pin networks can be seen by examining Fig. 1. A pin P, isolated from ground by a condenser C, is charged to some voltage V_1 through a large resistance R_2 . When the target plate moves in the direction of the arrow, it contacts the pin. The condenser C then discharges through R_1 , R_3 , and the coaxial cable, R_c , with the instantaneous signal on the coaxial cable determined by the relative values of these three resistances.

The value of the signal potential S down the cable is:

$$S = \frac{-V_1 \frac{(R_c R_3)}{(R_c + R_3)}}{R_1 + \frac{R_c R_3}{R_c + R_3}}$$

If the resistance R_1 is large compared to the combined resistance of R_3 and R_c , several pin networks can be connected together at B. And if the pins are alternately charged positively and negatively, an oscilloscope trace illustrated in Fig. 2 and 3 will be obtained. Fig. 2 is the type of record obtained when the time $R_1 C_1$ is long compared to the

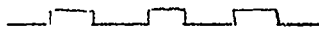

Fig. 2



Fig. 3

length of the trace, and Fig. 3 illustrates the type of record when $R_1 C_1$ is small compared to the times between pulses. Nominal values for the

components are

R_1 , 1000 to 4000 ohms; R_2 , 1 to 10 megohms; C_1 , 0.00005 to 0.1 μf .

One or more pins in each of two or more groups can be connected together as shown below by taking the precaution that the pins so connected have the same polarity. These are called fiducials. Usually the connections are made inside the pulse-forming network so that only one pin lead is necessary.

It is usually more convenient, if a slower pulse response can be tolerated, to locate the pulse-forming network some distance from the target plate and explosive. If this is done, the leads are extended at the places shown by the dashed line in Fig. 4. The type of shielded leads used has an effective impedance to a square pulse of about 100 ohms.

The terminating resistance, R_3 in Fig. 1, is used when possible reflections from the recording instruments would interfere with the record.

Most of the pin networks now used by GMX-4 consist of elements illustrated by Fig. 4 interconnected to give the desired correlation between records. In addition to the fiducials provided by the pins, pulses can be generated by some part of the firing circuit or timing units and used as pin pulses.

One network, which is now obsolete, consisted of a cathode follower and capacity decoupling between pins as shown in Fig. 5. Leads were ordinarily extended at the dashed line. R_1 , about 100 ohms, served as a terminating resistance for the pin leads and was sometimes placed directly on the pin. C_2 is very much larger than C_1 by a factor of 100 or more. Values of the condensers were C_1 , 50 to 200 μf ; C_2 ,

0.01 to 0.1 μ f. The signal potential developed between A and ground is:

$$S = \frac{-C_1 V}{C_1 + C_2}$$

but then the signal is attenuated about 40 percent by the cathode follower for which cathode bias is provided by a 500-ohm resistor at the input of the oscilloscope. A square pulse is generated.

Special networks have been used for particular purposes. One which was used to separate the small emf's developed by thermocouples from the large potentials accompanying explosions of H.E. is shown in Fig. 6. No signal will be seen at A as the same signal is applied as S_1 and S_2 . In practice S_1 included both the desired and undesired signals, and S_2 was only the undesired signal. The amplifier then cancelled the undesired signal and passed only the desired signal.

This amplifier was superseded by a balanced amplifier with double inputs, used when the signal developed by a pin was small, such as in air shock and polarization experiments. In the latter case a single pin is connected to each input.

The resistance of an ionized layer of shocked air was studied with the circuit in Fig. 7. The potential across R_1 was recorded as a function of time. C_1 was usually 1 or 2 μ f; and C_2 , 0.1 μ f. R_2 was usually much larger than the resistance of the cable. R_1 was made comparable to resistance of the layer being 10 to 1000 ohms for different shots.

A device, the multiple delay line, which combines time calibration with a pin network has also been used here. In its simplest form it

consists of a network similar to that of Fig. 4 with properly terminated coaxial cables of varying length for the pin leads. It is used when the symmetry of a plane wave is to be measured.

Ordinarily symmetry measurements require one oscilloscope for each pin if the asymmetries are small. Two pins, a positive and negative, can be used if the asymmetries are expected to be large enough that both pulses will not occur at the same time. By using a multiple delay line with different delays, 12 pins can be recorded on one oscilloscope. A disadvantage of this system is the larger amount of cable required.

A second type of multiple delay line is shown in Fig. 8.

The components R_1 , R_2 , and C_1 perform the same functions as in the pin network of Fig. 4. R_3 is a terminating resistance for the individual pin cable. The entire cable is made up in a roll with about 8-foot stubs extending out of the roll for individual pin leads. Because of its appearance it is called the octopus although it actually has 12 arms.

The big disadvantage of this type of multiple delay line can be seen by observing that at each T the potential divider action causes half of the signal to be lost.

After using the octopus of Fig. 8 for some time, and encountering difficulties with variations in oscilloscope sweep rates causing large errors in time, the so-called super octopus was built as illustrated in Fig. 9.

The functions of R_1 , R_2 , R_3 , and C_1 are the same as described for the octopus of Fig. 8. R_4 was added to match the delay sections to pulses traveling to the right and thus avoid reflections caused by the

mismatch of R_1 . This now appears to be an unnecessary precaution. In operation a single pin, P_1 , will introduce a pulse at different positions on the delay line. Other pins at P_2 , P_3 etc., are introduced at intermediate positions. The departure of pulses from the relative position occupied by them on a calibration record (made by shorting all pins connected to one octopus section simultaneously) is a measure of the asymmetry of the wave.

OSCILLOSCOPES

Goranson Program 1944-1945

Four oscilloscope units known as Model 100 were made by the electronics group for Dr. Goranson's program. They were useful for sweep durations from 3.0 μ secs to 200 μ secs. A video amplifier with a voltage gain of ten, and a rise time of approximately one-tenth microsecond was used to charge the vertical deflection plates of the 5CP11 Cathode Ray Tube. Four to five thousand volts was used for beam acceleration on the cathode ray tube. Calibration was provided by a crystal oscillator with frequencies of 500 kilocycles, 1.0, 2.0 and 5.0 megacycles. No delay systems were used with this equipment.

Oscilloscopes used by Minshall, Gittings, et al., at Alpha and Beta Sites

These oscilloscopes known as Model 300 were also made by the electronics group. The chief differences between the Model 100 and Model 300 were in the amplifier and CR tube. The Model 300 had a video amplifier with a voltage gain of 300, which was capable of a rise time of 0.15 μ sec. A 5JP11 CR tube was used on the Model 300. The sweep generator was identical to that used with the Model 100 oscilloscope. A variable time delay was available for the sweep trigger. It was common practice to put a sweep triggering

pin in the primacord leading to the high explosive lens and set the trigger delay to that required for the detonation wave to pass through the explosive train. This permitted the experimenter to anticipate the pin contacts and start the sweep generator a microsecond or so in advance of the contacts.

Time calibration was provided by a "Blanking Calibrator" which was coupled to the intensity grid of the CR tube. The "Blanking Calibrator" caused the trace to be blanked out every one microsecond or five microseconds, as selected.

Pins were coupled into the grid of a cathode follower pre-amplifier which was located in a protected position close to the shot at the firing pit. A multiple conductor cable was used to connect the pins to the cathode follower grid circuits. All networks were contained in the cathode follower preamplifier, consequently the expended portion of the shot was quite simple. The cathode follower "Preamp" was connected to a coaxial cable and thence to the video amplifier on the oscilloscope. This system was useable on sweeps of ten microseconds and longer. The rise time caused this system to be impracticable for faster sweeps.

Changes in Model 100 Oscilloscope Units in 1946 - 1947

The equipment was being used for high speed measurements, consequently an effort was made to make it useable at higher sweep speeds. New high potential power supplies were installed thus raising the beam accelerating potential to eight kilovolts. This higher potential made it possible to get a better photographic trace at high sweep speeds. The new 5RPL1A multi-band cathode ray tube which required lower potentials for spot deflection was installed in place of the 5CP11A. Another change

in method was the application of pin pulses directly to the vertical deflection plates. Pin charging potential was increased to compensate for the loss of the amplifier gain. Removing the amplifier reduced the pin pulse rise time to approximately 0.03 μ sec from the original 0.1 μ sec. With these changes, the Model 100 was useable for sweep durations as short as 1.5 μ sec compared to the original 3.0 μ sec.

Hughes Aircraft Company Oscilloscopes

Sometime in 1947, members of GMX-4 inspected an oscilloscope made for D. P. MacMillan's group by Hughes Aircraft Company. The group members were impressed by the ease of maintenance and good workmanship in the design of this oscilloscope. Consequently, GMX-4 negotiated with Hughes Aircraft Company for the purpose of securing equipment similar to the oscilloscope which had been built for D. P. MacMillan. Some of the features of the new Hughes Aircraft Company oscilloscopes were:

1. Slide rack mounting for ease of maintenance.
2. Sweep delay built into each sweep generator.
3. Marker identifier delay for inter-relating traces built into each sweep generator.
4. Continuously variable sweep duration from 1-125 microseconds.
5. Thyatron "Second trigger preventer" on trigger input.
6. Panel lights to indicate when sweep is reset, ready for firing.
7. Five independent vertical inputs through the amplifier.
8. Two direct inputs which bypass amplifier.
9. Video amplifier, gain of 125, rise time of 0.03 μ sec.
10. Time calibration provided by pulsed calibrator, with one and five μ sec pulses which could be phased with the trigger input to provide a standing pattern.

Edgerton, Germeshausen and Grier Oscilloscopes

EGG designed an oscilloscope to be used for recording extremely fast transients, 1.0 μ sec to 0.1 μ sec in duration. GMX-4 ordered two of these to be used for thin plate, free surface velocity measurements.

These oscilloscopes have 2D21 thyratrons to generate the 1000-volt saw tooth wave required for the horizontal sweep. A 24,000 volt, sixty-cycle, power supply is used to provide the beam acceleration potentials required for photographing these high speed sweeps. There is no amplifier and no delay unit. Fixed sweep duration of 3, 1, 0.3, 0.1, 0.03, 0.01 μ secs are available.

The linearity of the sweep and stability of sweep speed are poor compared to the Hughes Aircraft Company oscilloscopes. The poor linearity is caused by inherent features of the Winter's Sweep, and the instability of sweep speed is caused by poor filtering and lack of electronic regulation of plate potentials. The EGG oscilloscopes were used to obtain wave asymmetry correction data.

RECORDS

The pin pulses and the timing markers appearing on the oscilloscopes are recorded photographically.

The cameras used for recording take a plate 4" x 5". Spectroscopic emulsion 103-0 coated on glass plates is currently in use. Glass was not originally used as the base, but it has been found that glass gives much greater dimensional stability to the emulsion.

The images formed by f:2 lenses come out roughly 1 1/4" long, and contain up to 14 pulses per trace in addition to timing markers which may be recorded simultaneously with the pin pulses, or put on

the plate as a separate trace.

With present equipment one selects the delay before the start of the single sweep, the time duration of the sweep, and one of several timing marker intervals. As mentioned earlier, these features allow a time interval to be broken down into several sub-intervals and displayed on several oscilloscopes. By use of a common identifiable pulse on two or more records, the times for pulses on these records may be referred to a common origin. It is not usual for times to be referred to other than a quite arbitrary zero time which is picked for convenience.

When the photographic plates have been exposed and the records developed, the position of the pin pulses must then be determined and relative times assigned to these pin pulses. This may be done by carefully positioning the plate in a comparator and finding the position of the beginning of all pulses and all relevant timing markers. From these data by linear interpolation a time can be assigned to each pulse. These then allow one to assign a number pair, position and arrival time with arbitrary zero, to each pin. These are the primary data obtained in any experiment.

ACCURACY

Many factors influence the accuracy of the final result. These may be considered to be of two major classes. The first class consists of those factors which may cause the pin to give an incorrect result in contrast to the second class in which the pin gives a correct but unwanted result. The discussion which follows should be considered as discussing representative factors, incomplete, but with all the important items mentioned.

Since one of the two numbers desired is pin position, that, rather obviously, must be determined with the degree of accuracy required. Customary precision in this group at the present time requires pin position to be measured to an accuracy of 0.0002" although this value is not always attained. If the pin is a shock pin and in a hole in the metal under investigation, any irregularity in the bottom of the hole makes such a number meaningless. One of our major difficulties has been obtaining smooth, flat-bottomed holes of pin size. If shots are made up several days before firing there exists the possibility of the pin holder warping and thus changing the position of the pin. Measurements on the above may be made under ideal laboratory conditions. However the desired knowledge of pin position is actually that of the pin at the time of contact. Usually this is the same, but under certain conditions it is necessary to correct for pin motion.

It has been found by experience that the diameter of a pin must be kept small. As the diameter of the pin increases, if it is a pin measuring free surface motion, the pressure apparently builds up under the pin to a sufficiently high value that air may ionize and cause pre-discharge of the pin, giving an erroneous result.

Pins of different types may have entirely different closing times, such that pins which should indicate the same time of arrival of material, may actually differ by as much as 0.5 μ sec. This trouble is not serious since relative and not absolute times are desired, and pins of a given type apparently differ very little. Thus pin types are not customarily mixed.

Pin records may also lead to incorrect arrival times due to perturbation of one pin by another. This perturbation might be due to

a pin being rather severely struck so that material is splashed around making contact with nearby pins prematurely. This is not ordinarily of much importance.

The design of the shot itself can cause difficulties if certain precautions are not taken. It is necessary to get a good fit between the explosive system and the metal under test. The pin leads must be the same length or account taken of the difference in transit time along them. The results may lead to erroneous conclusions if rarefactions from the edges of the plate of material under study are allowed time to change the pressure between pin records on the same group. Wave front shape and tilt, or more important, the change in wave shape or tilt have a very important bearing on the results. Pins are usually arranged in regular arrays, usually circles. A very poor method is to arrange successive displacements progressively around the circle. Many arrangements have been worked out for different numbers of pins to minimize effect of tilt and the like. Arrangements were analyzed by G. Felt and D. Bancroft and more recently by E. Gittings of this group, and by R. E. Duff (IA 1275) of the division office.

However, assuming that the pulses from the pins occur at the proper time, it is still necessary that they show on the oscilloscope screen at proper intervals. This brings in the rise time or band width of the electronic equipment, the linearity of the oscilloscope sweep, and the accuracy of the timing markers. Extensive tests have been made on the linearity of sweep and a great deal of effort has gone into improving the linearity. A timing marker generator has been developed by E. Houston of this group (IA 1470) and the pulses from it calibrated

UNCLASSIFIED

against a signal from WWV. It is felt that the timing pulses are slightly better than the accuracy with which pulses can be read on the comparator.

The most important factors in getting good numbers from pin pulses have turned out to be the focus of the trace, the amplitude of the pulses, and the straightness of the sweep. The pulse amplitude should be kept as small as possible. If the trace does not go through the center of the screen, it may produce a curved image which leads to difficulty in aligning the record in the comparator. For precise work, it has turned out to be well worth while to photograph the trace to check the focus.

The adjustment of the focus and of the intensity of the electron beam allow control of a photographic effect which has caused a little trouble in the past. This effect is one in which an overexposed grain in the film emulsion can cause exposure of neighboring grains which should show no exposure.

The accuracy of reading of a record in a comparator depends upon many factors, but pulses are customarily read to the nearest thousandth of a millimeter. The distance between the same pulses for two readings by the same person or for two readers generally agree to five-thousandths of a millimeter. These numbers are for good records; for poor records, the disagreements can be as much as two-hundredths of a millimeter.

CURRENT PRACTICE

Figs. 10 and 11 illustrate the types of pins in current use and the present method of positioning pins for shock measurements. In Fig. 10 either type A or E may be used to measured either shock or free surface arrival, B and C are essentially shock pins and are used when conducting

UNCLASSIFIED

material is under test. B is more likely to be chosen if the material is of a powdery nature. E is the type most likely to be used for a non-conducting material since the strip of silver foil serves to make the contact with the pin when the foil is struck by the moving, non-conducting surface. D, F, and G all may be used as free surface measuring devices. Of these, D is the most useful if one desires to place many pins in a small space. F and G may be used for preliminary measurements in which the highest attainable accuracy may not be required.

Fig. 11 which is discussed in detail on page 17 shows the method which is used now to make the determination of pin locations easier and more accurate.

Fig. 4 illustrates the type of pulse-forming network currently in use.

These remarks on current practice should be considered only to be true in a rather limited sense. Improvements and changes to fit new conditions occur frequently so that what may be current now may well change to meet new problems.

UNCLASSIFIED

2170

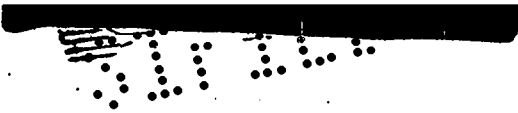

UNCLASSIFIED

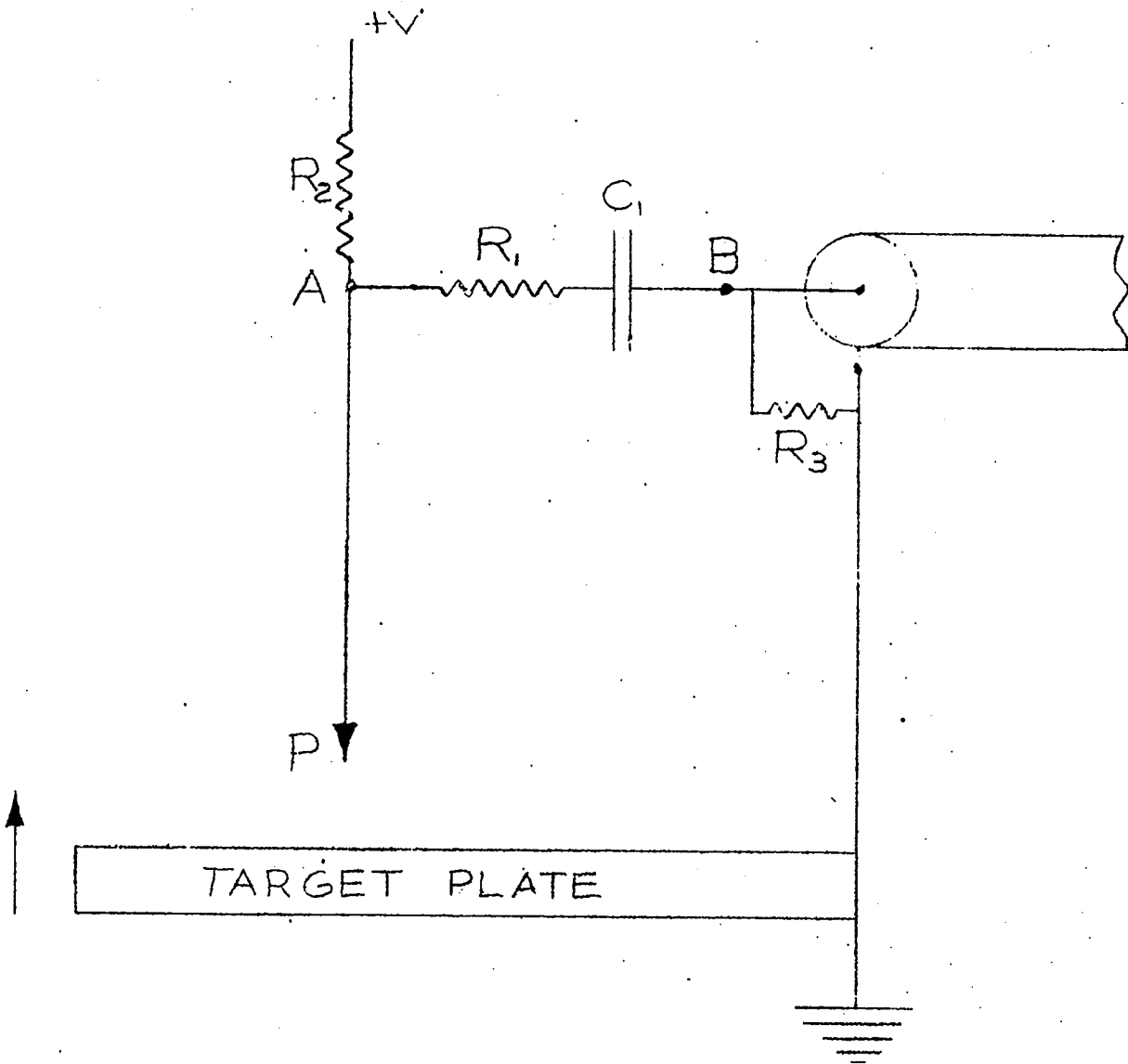

UNCLASSIFIED

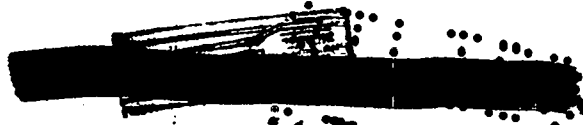

UNCLASSIFIED

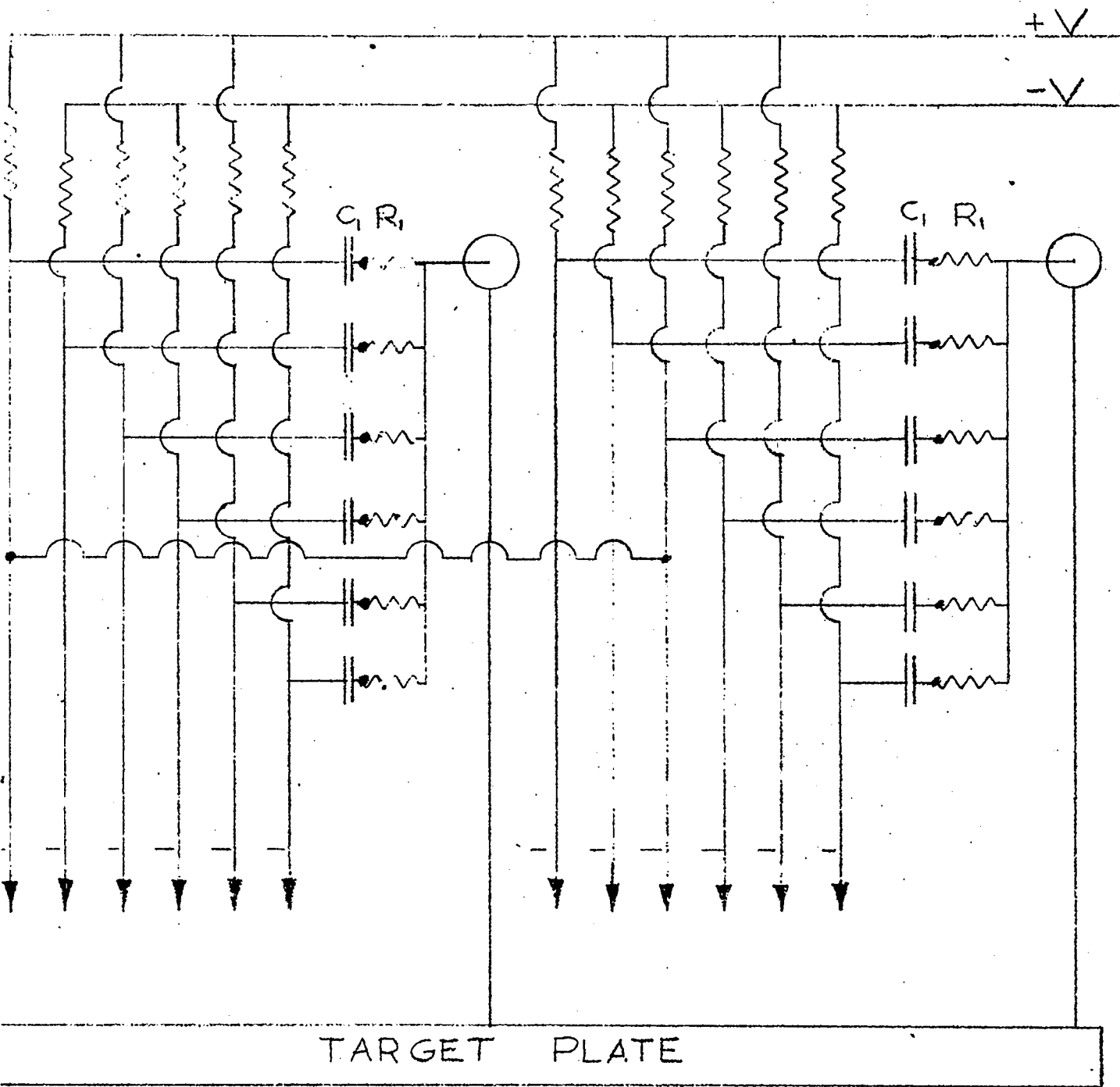

TARGET PLATE

UNCLASSIFIED

FIG. 4

APPROVED FOR PUBLIC RELEASE

-15-

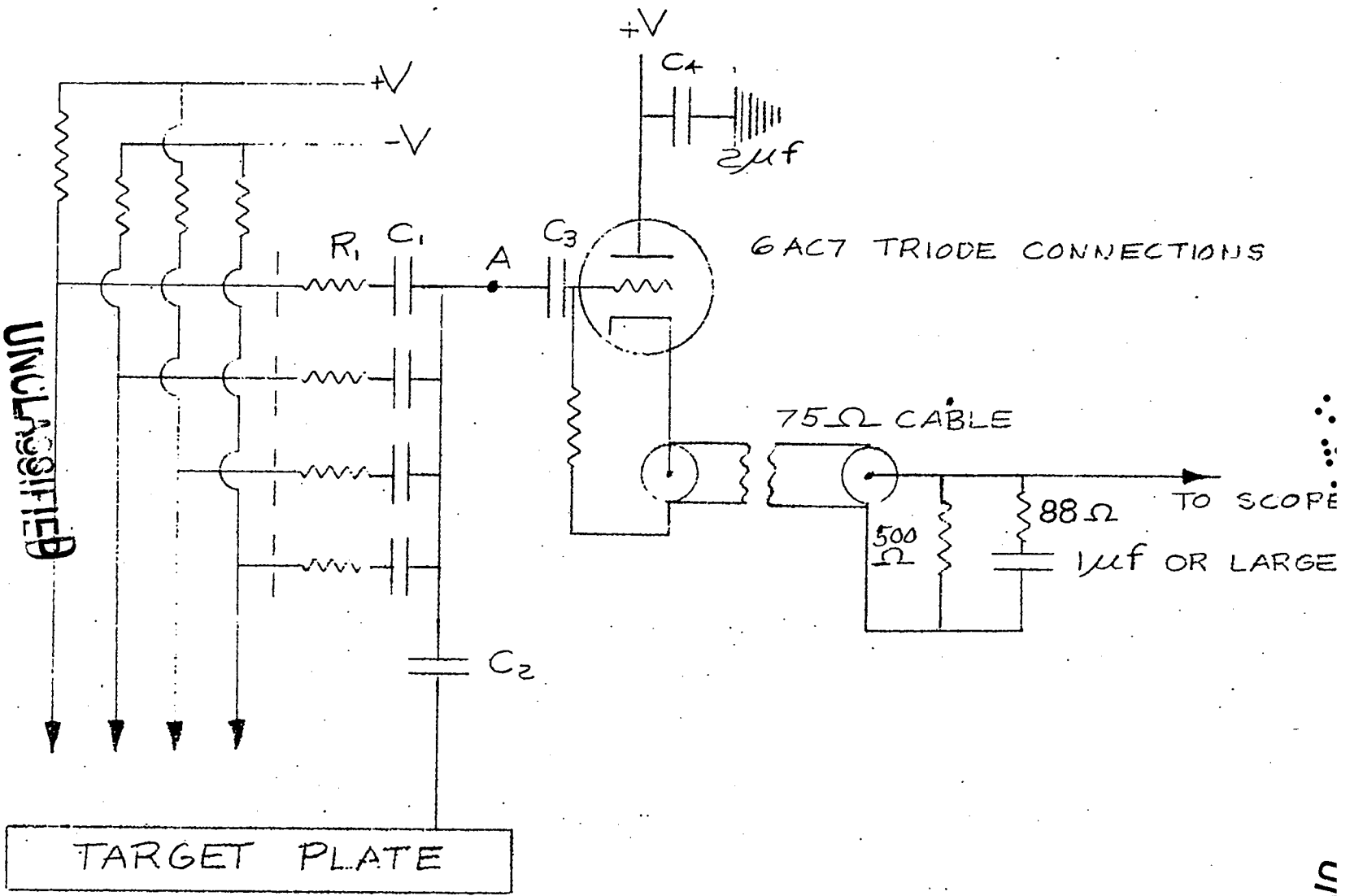

6AC7 TRIODE CONNECTIONS

75 Ω CABLE

TO SCOPE

FIG. 5

UNCLASSIFIED

UNCLASSIFIED

APPROVED FOR PUBLIC RELEASE

UNCLASSIFIED

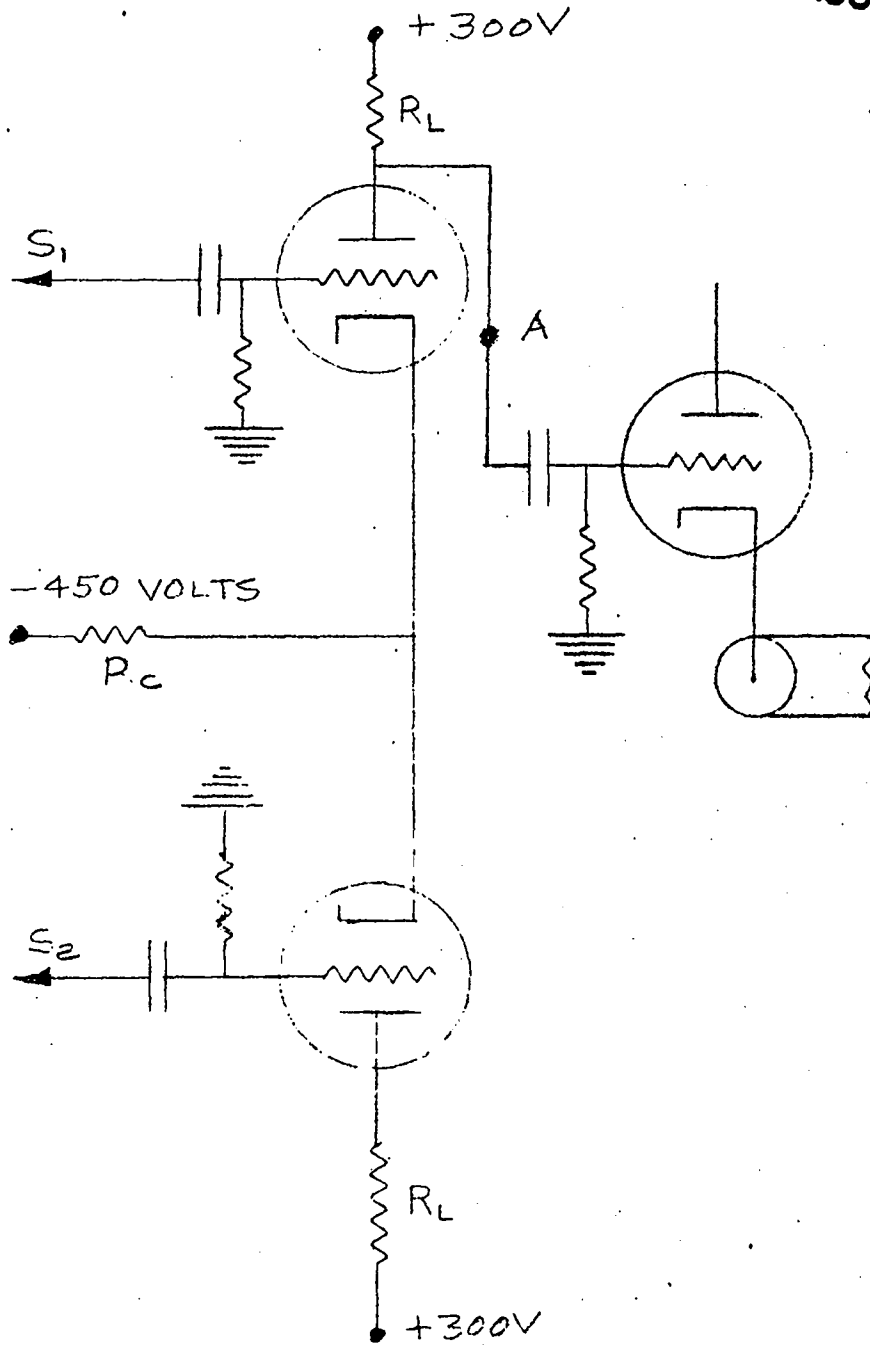

$$R_c \gg R_L$$

UNCLASSIFIED

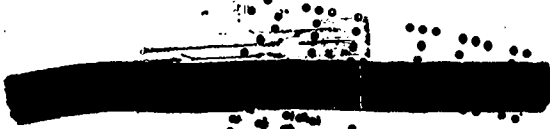

UNCLASSIFIED

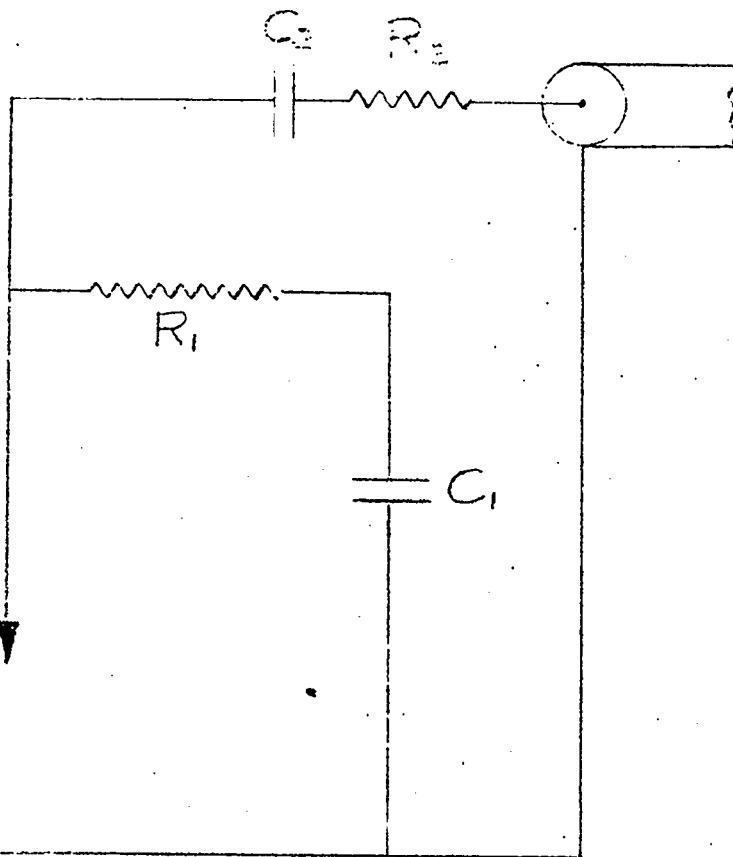

FIG. 7

UNCLASSIFIED



UNCLASSIFIED

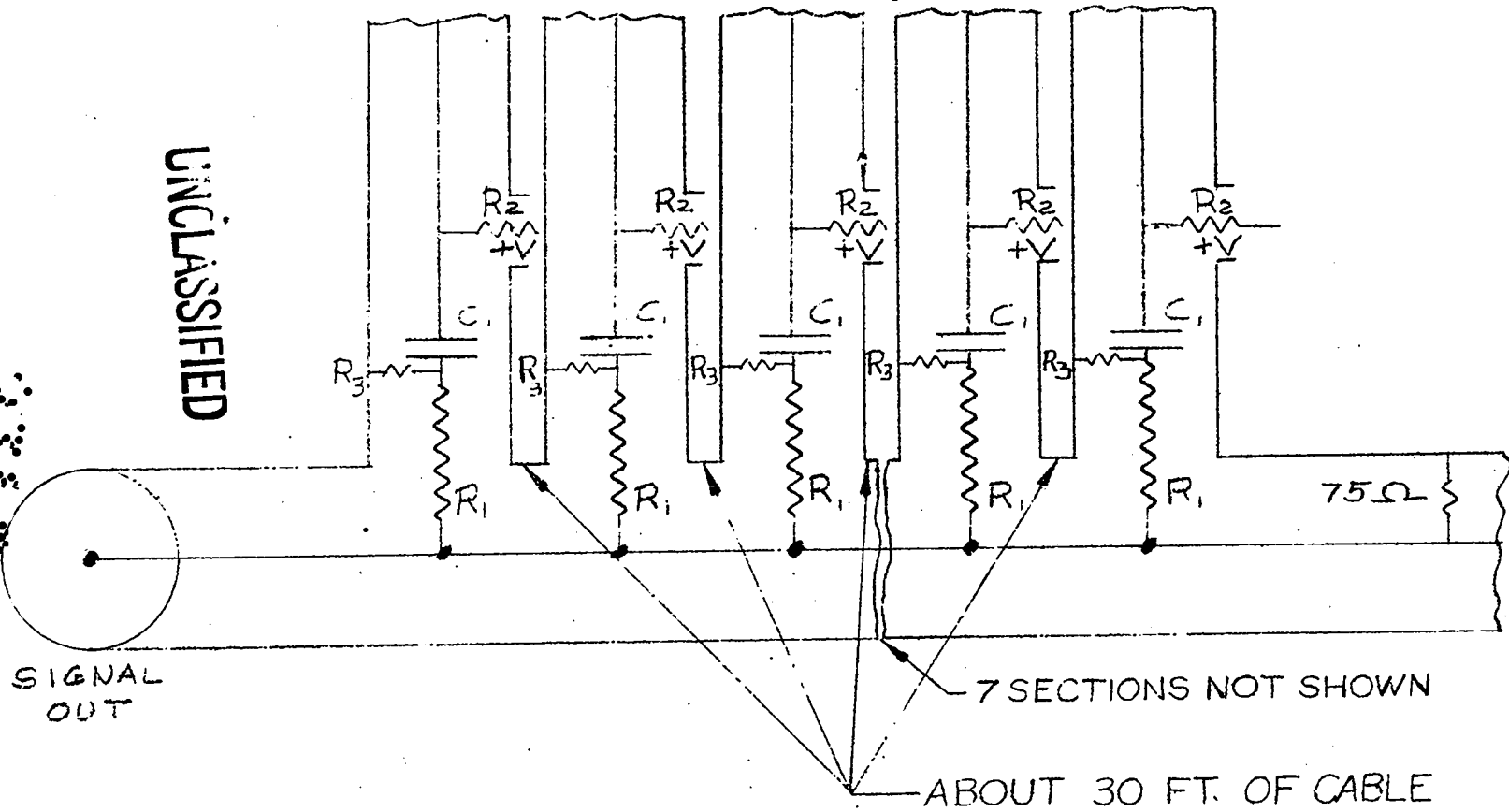
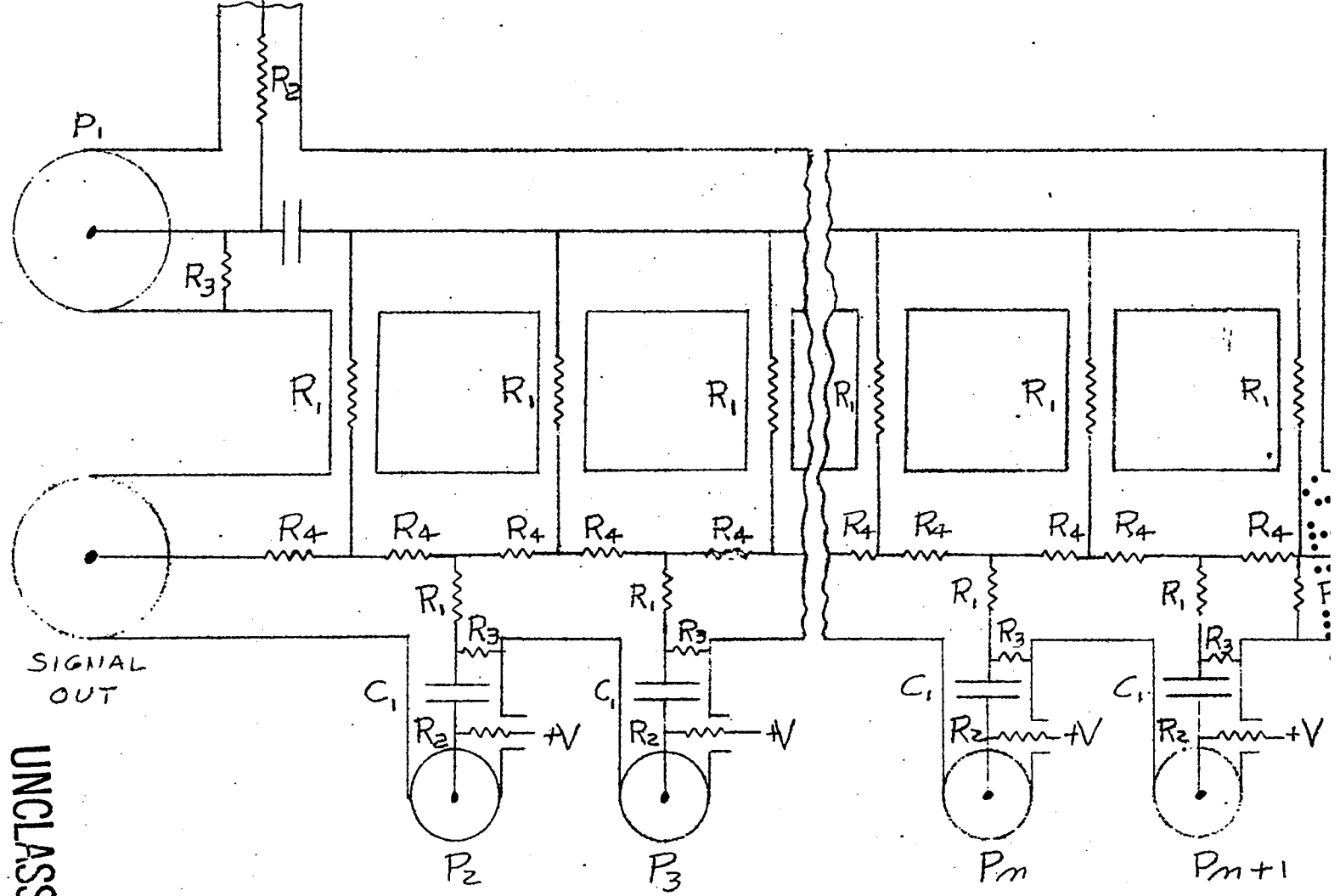

FIG. 8



UNCLASSIFIED

FIG. 9

UNCLASSIFIED

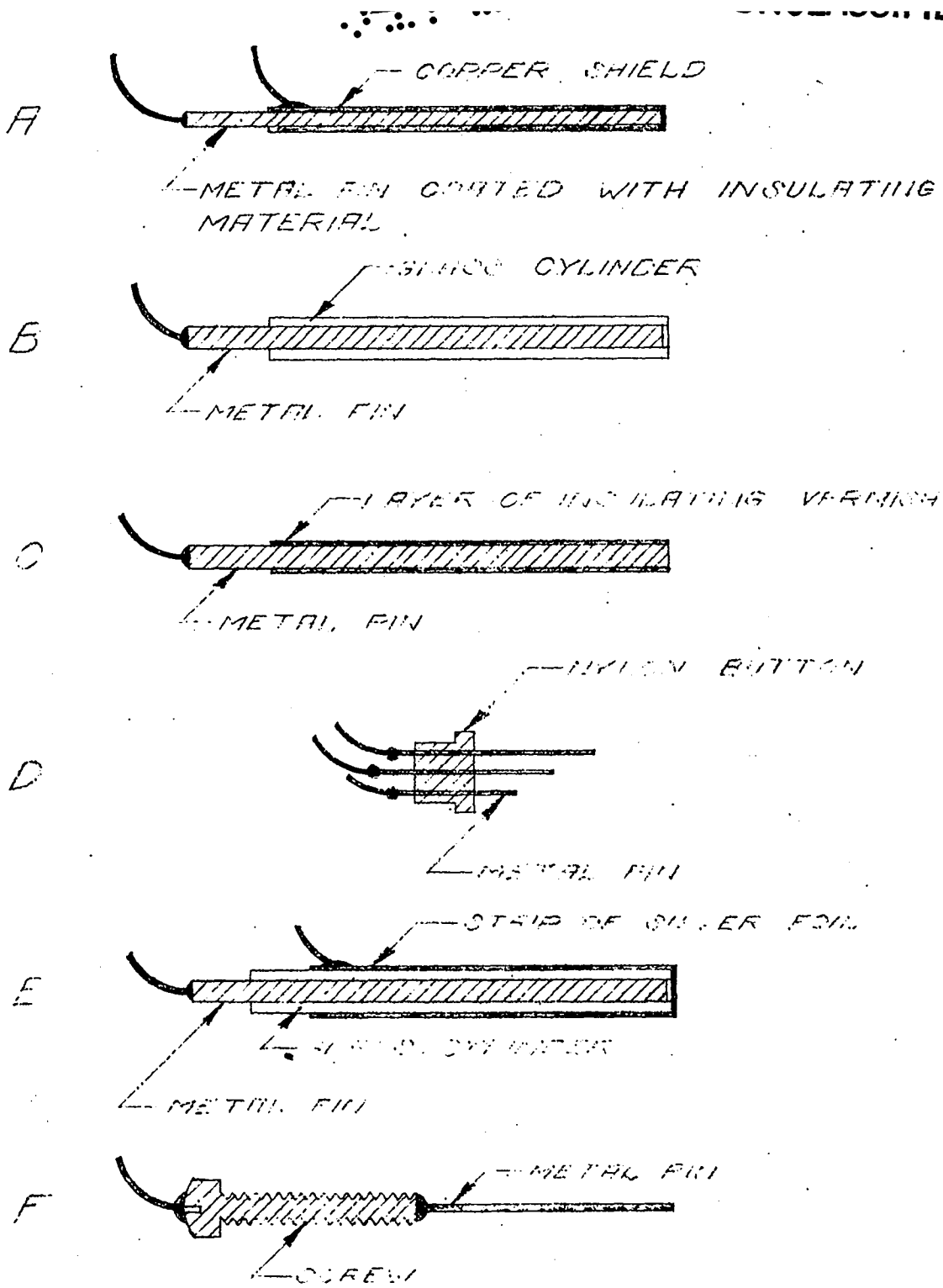

UNCLASSIFIED

UNCLASSIFIED

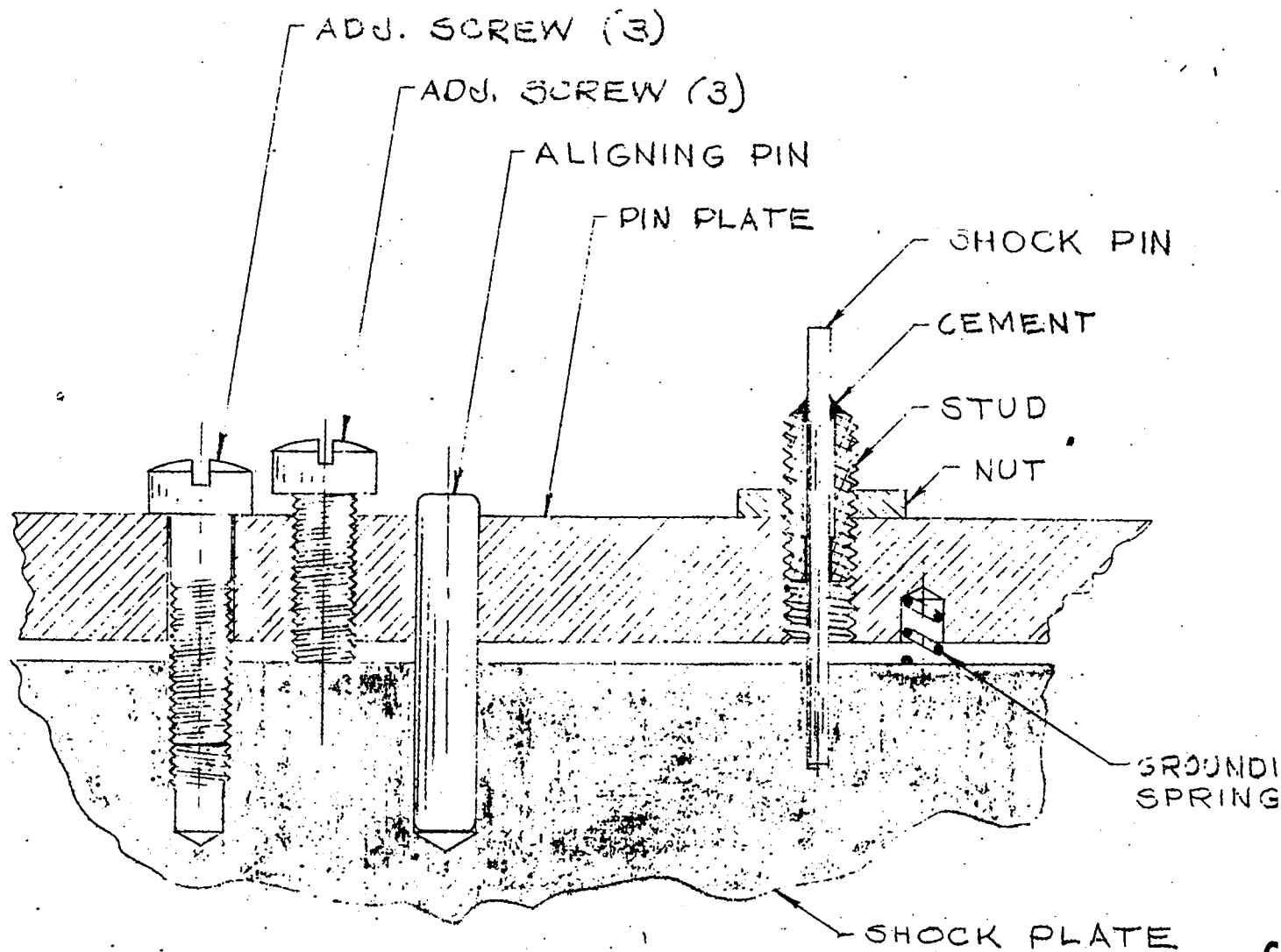

SHOCK PIN ASS'Y.

Figure A1

APPROVED FOR PUBLIC RELEASE

UNCLASSIFIED

7-11-54

REPORT LIBRARY

AUG 5 1954