

LA--25

Copy 2 of 20  
Series..A

CIC-14 REPORT COLLECTION

**REPRODUCTION  
COPY**

LOS ALAMOS NATIONAL LABORATORY



3 9338 00349 6139

UNCLASSIFIED Do not  
del.

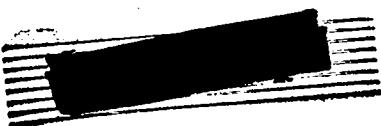

LA REPORT 25



September 21, 1943.

This document contains 14 pages

MEASUREMENTS OF  $\nu_{49/\nu_{25}}$

WORK DONE BY:

- C. L. Bailey
- J. M. Blair
- D. H. Frisch
- K. Greisen
- A. O. Hansen
- J. M. Hush
- M. Kahn
- R. D. Krohn
- J. L. McKibben
- R. G. Nuckolls
- R. Perry
- H. T. Richards
- C. Richman
- R. F. Taschek
- C. M. Turner
- A. C. Wahl
- J. H. Williams

**PUBLICLY RELEASABLE**

Per *M. Sandoval* **RSS-18** Date: 9-21-88  
By *Martin Holley* **CIC-14** Date: 3-7-96

REPORT WRITTEN BY:

J. H. Williams

Classification changed to UNCLASSIFIED  
by authority of the U. S. Atomic Energy Commission,

Per *H-F. Cannon*, 3-2-86 - list No. 3  
By REPORT LIBRARY *Steve J. Smiley*  
3-27-86

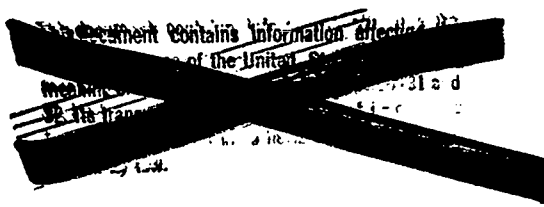

Physics Fission



LOS ALAMOS NATL. LAB. LIBS.  
3 9338 00349 6139

UNCLASSIFIED

UNCLASSIFIED

-2-

ABSTRACT

The ratio of the number of neutrons emitted per fission in 49 to the number of neutrons emitted per fission in 25 has been measured by two different methods. The values of  $\nu_{49}/\nu_{25}$  obtained were  $1.20 \pm .09$  and  $1.25 \pm .12$ . The low-energy limits of the fission neutrons detected in the two experiments were .72 and 1.2 Mev respectively.

UNCLASSIFIED

MEASUREMENTS OF  $\nu_{49}/\nu_{25}$ 

The number of neutrons emitted per fission in  $^{239}\text{Pu}$ , relative to the number of neutrons emitted per fission in  $^{235}\text{U}$ , has been investigated. The experimental observations are divided into two categories: The determination of the relative number of neutrons emitted from known masses of 49 and of 25 per unit of slow neutron flux, and the determination of the relative number of fissions per microgram of 49 and 25 in the same neutron spectrum. From these observations one can obtain the desired  $\nu_{49}/\nu_{25}$ .

In both of these experiments the sources of neutrons were lithium targets, approximately 75 kv thick, bombarded by 1.95 Mev protons accelerated by Van de Graaff generators. The maximum energy of the primary neutrons was therefore 0.15 Mev. These primary neutrons were transformed to slow neutrons by surrounding the target and detectors by either paraffin or water. The advantages of this source of slow neutrons are the complete absence of primary neutrons of sufficient energy to be confused with the neutrons arising from the fission process and the fortuitously large yield from the  $\text{Li}(p, n)$  reaction near the neutron threshold.

PROTON-RECOIL METHOD

The relative number of neutrons emitted from known masses of 49 and 25 has been observed by two independent methods. The first method was to count the number of protons recoiling from a thick paraffin layer surrounding a sample of fissionable material. The experimental chamber is shown in Fig. 1.

UNCLASSIFIED

Document contains information...  
 U. S. C. 50-31 and  
 32. Its... of its contents  
 to an unauthorized...  
 by law.

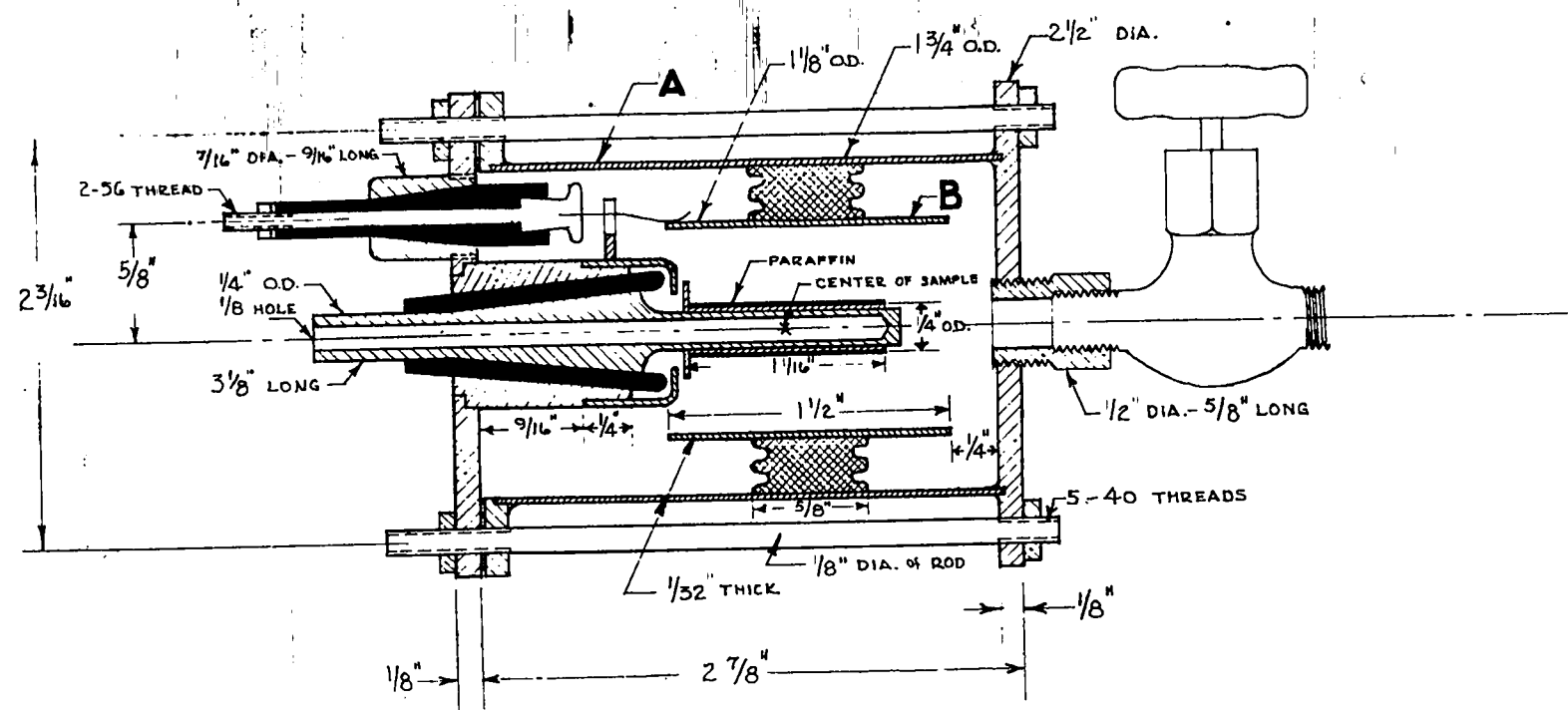



- TAPERS ARE ALL 5°
-  HARD RUBBER
  -  BRASS
  -  LUCITE

FIG. 1  
 PROTON RECOIL CHAMBER

APPROVED FOR PUBLIC RELEASE

APPROVED FOR PUBLIC RELEASE

The outer cylinder, A, serves as a grounded electrostatic shield and a container for spectroscopically pure argon at 100 lbs. per sq. in. The copper-plated cylinder, B, serves as a positive high-voltage electrode. The central collecting electrode is a hollow brass tube. The outside of this tube is covered with a "thick" (approximately 1/4 mm) paraffin coating over which is rolled a single layer of aluminum foil 0.15 mg/cm<sup>2</sup> thick. This aluminum provides a conducting surface for the collecting electrode. It also reduces the energy of undesired recoils from the enclosed paraffin which are produced by primary neutrons, of energies up to 150 kv, that have not been slowed by the paraffin surrounding the whole counter. Known masses of fissionable materials contained in soft-glass capillaries are placed within the central tube. Thus the slow neutrons incident upon these materials produce fissions and associated fast neutrons within the tube. Some of these neutrons produce recoils in the surrounding paraffin layer which are detected as single ionization pulses in the gas space inside the high-voltage electrode.

Observations were made of the number of such pulses with a sample of normal alloy containing 3780 micrograms of 25, with 142.3 ± 3.7 micrograms of 49, and with no material, contained in identical capillary tubes which were separately introduced within the central hollow electrode. These numbers were normalized to an arbitrary unit of slow-neutron flux by simultaneous recording of the fission rate in an adjacent monitor chamber which contained 238 micrograms of 25. Table I shows the actual data obtained in 30 hours of operation. Also shown is the statistical error arising from the limited numbers involved.

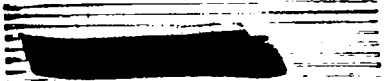

	25 + Background	49 + Background	Background
# neutrons observed	3100	650	465
$\frac{\# \text{ monitor counts}}{100}$	7115	12037	23134
$\frac{\# \text{ neutrons} \times 10,000}{\# \text{ monitor counts}}$	$43.57 \pm .78$	$5.40 \pm .21$	$2.01 \pm .09$
Net rate	$41.56 \pm .79$	$3.39 \pm .23$	

TABLE I.

It is clear from these data that the relatively large background counting rate makes it difficult to obtain a high degree of accuracy. It is worth noting that one can account for this background by assuming that the materials of the chamber contain one part in a million of boron.

#### THORIUM-FISSION METHOD

The second method of determining the relative number of neutrons emitted from known masses of 49 and 25 is based on an entirely different physical phenomenon. In this case the fission neutrons were detected by their ability to produce fission in thorium, whereas the primary neutrons had energies less than the 1.2 Mev fission threshold\* of thorium. The detection efficiency,  $2 \times 10^{-6}$ , is extremely low compared to the former experiment. For this reason it was necessary to employ a slow-neutron flux of approximately  $10^7$  as compared to the former flux of  $3 \times 10^5$ .

\* This value of the threshold was determined in a separate investigation which will be reported later.

~~... information ... the meaning of the ... within the 32 ... or the rev ... C. 50-31 and ... to an unauthorized person ... by law.~~

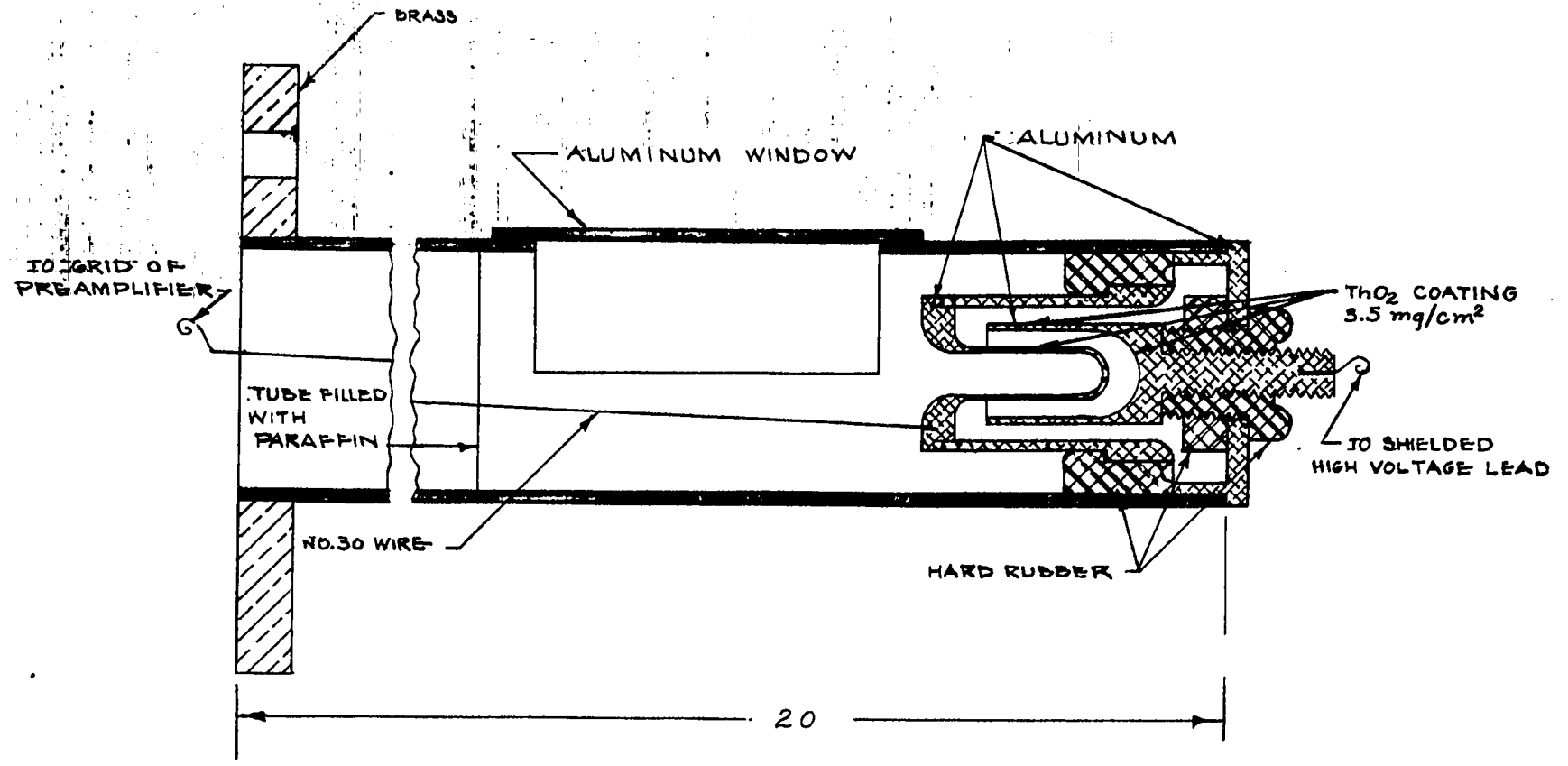

FIG. 2  
SCALE - TWICE FULL SIZE

APPROVED FOR PUBLIC RELEASE

APPROVED FOR PUBLIC RELEASE

~~...~~



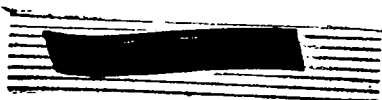

The experimental chamber is shown to twice scale in Fig. 2. A series of nesting aluminum cylinders, connected together to form the collector and the high voltage electrode, were coated with thorium oxide\* approximately  $3.5 \text{ mg/cm}^2$  thick. These electrodes were surrounded by a grounded aluminum cylinder. The whole chamber was surrounded by a lucite cylinder which was submerged in a water bath. The slow neutrons present produced fissions and associated fast neutrons in the fissionable materials contained within the hollow innermost electrode. These fast neutrons produce fission in the thorium layers. The secondary fission fragments are detected by their ionization in the air at atmospheric pressure between the chamber electrodes (separation  $\sim 1.5 \text{ mm}$ ).

In this experiment an appreciable background counting rate arises from photofission of the Th by gamma rays created by slow-neutron capture in the materials of the chamber\*\*. Tests revealed that copper, brass and especially iron were objectionable. Aluminum appeared to be the most suitable material for construction of such a counter. Also it was necessary to use the minimum amount of thorium commensurate with adequate detection efficiency in order to reduce this background effect. For these reasons the small aluminum chamber shown in Fig. 2 was finally adopted.

The results of a 24-hour run are shown in Table II.

---

\* The thorium oxide was purified to remove U by S. Weissman, by the use of the ether-extraction process. Analysis by fluorescence technique of the purification products showed the U content to be  $< .1/10^6$ .

\*\* This was established in a series of tests to be described in a separate report.

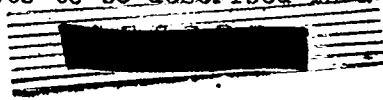

-9-

	4970 ug of 25 + Background	142.3 ± 3.7 ug of 49 + Background	Background
# neutrons detected	3006	694	298
# monitor counts /64	9762	19549	18172
$\frac{\# \text{ neutrons} \times 64000}{\# \text{ monitor counts}}$	308.0 ± 5.6	35.48 ± 1.35	16.41 ± .95
Net rate	291.6 ± 5.7	19.07 ± 1.67	

TABLE II.

The statistical errors shown are calculated from the number of neutrons counted.

PROTON-RECOIL METHOD WITH DIFFERENT BIAS

A third attempt to determine the relative number of neutrons was made. This experiment employed the proton-recoil chamber described above, in a region of slow-neutron flux approximately ten times as great as in the first experiment. Under these circumstances it was found necessary to bias the proton recoil detector to accept only pulses of greater magnitude than in the former experiment. The effect of such biasing was to reduce the net effect due to the small 49 sample relative to the background counting rate. This reduction makes the results less trustworthy but it is of interest to report them inasmuch as the bias may influence the value of  $\frac{^{249}\text{Pu}}{^{235}\text{U}}$  as will be discussed later in this report. These observations are tabulated below.

	3780 ug of 25 + Background	142.3 ± 3.7 ug of 49 + Background	Background
# neutrons detected	3547	1444	1689
# monitor counts 100	4622	8314	13732
# neutrons x 100 # monitor counts	.770 ± .013	.174 ± .0046	.123 ± .0030
Net rate	.647 ± .013	.051 ± .0055	

TABLE III.

The above three experiments determine the relative number of neutrons emitted per microgram of 49 and 25 if one assumes that the neutron spectrum produced by each is the same. There is no experimental evidence on the spectrum of the neutrons from the fission of 49. In the case of 25 Bloch and Staub (CF 525 and LA 17) have shown that the maximum of the spectrum occurs at approximately 0.8 Mev. The minimum-energy neutrons detected in the three experiments described above are .72, 1.2 and .86 Mev respectively.

If the neutron spectra were appreciably different in the energy range above 0.7 Mev, the ratio  $v_{49}/v_{25}$  obtained in these three experiments might be expected to be different. However the sensitivity of the recoil-proton detector as a function of neutron energy, as calculated by Richman, indicates that it is not possible to make a definite distinction between the results of the three experiments. In all cases, only that part of the fission spectrum above 1 Mev is detected with appreciable efficiency.

RELATIVE FISSION CROSS SECTION

In order to obtain  $\nu_{49}/\nu_{25}$ , or the relative number of neutrons per fission, from the relative number per microgram, it is necessary to determine the relative fission cross section of these materials for the particular neutron spectrum employed in the experiment described above.

For the paraffin geometry pertaining to the first and third experiments we have compared two aliquots of the original solution containing the 49 sample with various uranium samples. These aliquots were  $0.718 \pm 0.013$  % and  $1.12 \pm 0.02$  % of the amount of 49 used in the neutron experiments. The number of alpha particles from these aliquots when dried in a thin film on platinum has been independently determined by Mr. Chamberlain and by members of the chemical group. Dr. A. C. Wahl also determined the mass of these samples by further dilution and alpha counting. Assuming that 49 has a half-life of 21,300 years the masses of these aliquots was found to be  $1.02 \pm .02$  and  $1.60 \pm .03$  micrograms respectively. From these values and the percentages of the original material in these aliquots the mass of 49 used in the earlier experiments is calculated to be  $142.3 \pm 3.7$  micrograms.

The 25 samples, with which these aliquots have been compared in a double fission chamber to give relative fission cross section, are thin foils of normal uranium containing .65, 3.54 and 10.6 micrograms of 25 and an enriched sample containing 17.9 micrograms of 25. The 25 content of the latter sample was obtained by comparing it with 500- and 1500-microgram foils of normal alloy.

These intercomparisons reveal that the cross section for fission of 49 is  $1.83 \pm 3\%$  times that of 25 for the paraffin geometry case if one accepts the masses of the 49 samples to be those determined by alpha-particle-counting methods.

-12-

Measurements on the heavier aliquot of 49 and the 0.65 ug of 25 described above show that the relative cross section for fission with water geometry is essentially the same as that determined for the paraffin geometry.

### REDUCTION OF DATA

The data described above can be treated in several ways to obtain values for  $\nu_{49}/\nu_{25}$ . We have considered that the least uncertainty in the result will occur if the aliquots are taken to be the measured  $0.718 \pm 0.013\%$  and  $1.12 \pm 0.02\%$  of the amount of the 49 used in the neutron experiments. If  $M_{5n}$  and  $M_{9n}$  be the masses of 25 and 49 respectively used in the neutron experiments,  $M_{5f}$  the mass of 25 used in the most reliable fission-comparison experiments,  $M_{9f_1}$  and  $M_{9f_2}$  the masses of 49 in the two aliquots of the total 49 sample, these aliquots being used in the fission comparison experiments, we may represent the two experiments as follows.

The relative number of neutrons observed in the neutron-comparison experiments is

$$\frac{N_5}{N_9} = \frac{M_{5n} \sigma_{25} \nu_{25}}{M_{9n} \sigma_{49} \nu_{49}}$$

The relative number of fissions observed in the fission-comparison experiments is

$$\frac{F_5}{F_9} = \frac{M_{5f} \sigma_{25}}{M_{9f_1} \sigma_{49}}$$

Therefore

$$\frac{\nu_{49}}{\nu_{25}} = \frac{F_5/F_{9_1}}{N_5/N_9} \times \frac{M_{9f_1}}{M_{9n}} \times \frac{M_{5n}}{M_{5f}}$$

The observations and the values of these quantities are listed below with the results calculated for each of the three neutron-comparison experiments.

-13-

A. PROTON-RECOIL EXPERIMENT      BIAS .72 Mev

$$(1) \quad \frac{N_5}{N_9} = \frac{41.56 \pm .79}{3.39 \pm .23} = 12.25 \pm 7\%$$

$$(2a) \quad F_5/F_{91} = 1.25 \pm 1.8\%$$

$$(2b) \quad F_5/F_{92} = 1.87 \pm 2.2\%$$

$$(3) \quad M_{5n} = 3780 \gamma$$

$$(4) \quad M_{5f} = 3.54 \gamma$$

$$(5a) \quad \frac{M_{9f1}}{M_{9n}} = .0112 \pm .0002$$

$$(5b) \quad \frac{M_{9f2}}{M_{9n}} = .00718 \pm .00013$$

$$(a) \quad \frac{\nu_{49}}{\nu_{25}} = \frac{1.25 \pm 1.8\%}{12.25 \pm 7\%} \times \frac{M_{9f1}}{M_{9n}} \times \frac{M_{5n}}{M_{5f}}$$

$$= \frac{1.25 \pm 1.8\%}{12.25 \pm 7\%} \times .0112 \pm 1.8\% \times \frac{3780}{3.54}$$

$$= 1.222 \pm 7\frac{1}{2}\%$$

$$(b) \quad \frac{\nu_{49}}{\nu_{25}} = \frac{1.87 \pm 2.2\%}{12.25 \pm 7\%} \times .00718 \pm 1.8\% \times \frac{3780}{3.54} = 1.175 \pm 7\frac{1}{2}\%$$

We then have an average value of

$$\frac{\nu_{49}}{\nu_{25}} = \underline{\underline{1.20 \pm .09}}$$

B. PROTON-RECOIL EXPERIMENT

BIAS of .86 Mev

$$(1) \quad N_5/N_9 = \frac{.647 \pm .013}{.051 \pm .0055} = 12.68 \pm 11\%$$

All other data the same as in A.

We then have an average value of

$$\frac{\nu_{49}}{\nu_{25}} = \underline{\underline{1.16 \pm .13}}$$

C. THORIUM-FISSION DETECTOR

$$(1) \quad N_5/N_9 = \frac{291.6 \pm 5.7}{19.07 \pm 1.67} = 15.30 \pm 8.8\%$$

$$(3) \quad M_{5n} = 4970 \text{ } \gamma$$

All other data the same as in A.

$$(a) \quad \frac{\nu_{49}}{\nu_{25}} = \frac{1.25 \pm 1.8\%}{15.30 \pm 8.8\%} \times .0112 \pm 1.8\% \times \frac{4970}{3.54} = 1.28 \pm .12$$

$$(b) \quad \frac{\nu_{49}}{\nu_{25}} = \frac{1.87 \pm 2.2\%}{15.30 \pm 8.8\%} \times .00718 \pm 1.8\% \times \frac{4970}{3.54} = 1.22 \pm .12$$

$$\text{Average} = \underline{\underline{1.25 \pm .12}}$$

It is clear from the values of  $\nu_{49}/\nu_{25}$  obtained, namely,  $1.20 \pm .09$ ,  $1.16 \pm .13$  and  $1.25 \pm .12$ , that it is not possible to distinguish any effect of differences in  $\nu$  which may be caused by differences in the fission spectrum of 25 and 49. One may therefore conclude that these experiments indicate that the value of  $\nu_{49}/\nu_{25}$  is  $1.20 \pm .09$ .