

LA-10213-MS

C.1

Los Alamos National Laboratory is operated by the University of California for the United States Department of Energy under contract W-7405-ENG-36.

For Reference

Not to be taken from this room

*GNAT - An Infrared Homing
Anti-personnel Micromissile*

LOS ALAMOS NATIONAL LABORATORY



3 9338 00318 6441

Los Alamos Los Alamos National Laboratory
Los Alamos, New Mexico 87545

DISCLAIMER

This report was prepared as an account of work sponsored by an agency of the United States Government. Neither the United States Government nor any agency thereof, nor any of their employees, makes any warranty, express or implied, or assumes any legal liability or responsibility for the accuracy, completeness, or usefulness of any information, apparatus, product, or process disclosed, or represents that its use would not infringe privately owned rights. Reference herein to any specific commercial product, process, or service by trade name, trademark, manufacturer, or otherwise, does not necessarily constitute or imply its endorsement, recommendation, or favoring by the United States Government or any agency thereof. The views and opinions of authors expressed herein do not necessarily state or reflect those of the United States Government or any agency thereof.

LA-10213-MS

Issued: March 1985

GNAT—An Infrared Homing Antipersonnel Micromissile

Eugene H. Farnum



Los Alamos Los Alamos National Laboratory
Los Alamos, New Mexico 87545

CONTENTS

	<u>Page</u>
ABSTRACT	1
I. INTRODUCTION	3
A. The Current State of Affairs	3
B. The New Technologies	4
II. OPERATION ANALYSIS	8
A. The Mission	8
B. Launch Options	8
C. Cost Effectiveness	8
D. The Nominal Target	9
III. CURRENT DESIGN CRITERIA	11
IV. TARGET DETECTION	13
A. Detectors	13
B. Single Aperture Optical Systems	20
C. Multiaperture Optical Systems	20
D. Target Acquisition Range	24
V. GUIDANCE AND FLIGHT CONTROL	28
A. Piezoelectric Bimorphs	28
B. Guidance	30
VI. MISSILE AERODYNAMICS	32
VII. PROPULSION	35
VIII. WARHEAD DESIGN	36
IX. POWER SUPPLY	37
X. UNCERTAINTIES IN DESIGN AND FEASIBILITY	38
XI. BELLS, WHISTLES, AND COST CONTROL	39
XII. ACKNOWLEDGMENTS	41
REFERENCES	41

FIGURES

	<u>Page</u>
Fig. 1. The vicious circle leading to large missiles and high-value targets	4
Fig. 2. Features of the GNAT--IR homing antipersonnel micromissile . . .	6
Fig. 3. Number of rounds fired by infantry rifles per enemy casualty inflicted for recent United States conflicts	10
Fig. 4. Example of a commercial thermoelectrically cooled PbSe IR detector from the 1983 Catalog of Optoelectronics Inc., Petaluma, California	15
Fig. 5. Hg _{1-x} Cd _x Te detector performance data at 77K. "Performance of commercial photon detectors," from <u>The Infrared Handbook</u> , William L. Wolfe and George J. Zissis, US Government Printing Office, 1978, p. 11-85	16
Fig. 6. PbSe detector performance data at 145 to 250K. Same source as Fig. 5, p. 11-73 (Ref. 29)	17
Fig. 7. Maximum detector temperature for blip operation vs energy gaps for photon detectors. Same source as Fig. 5, p. 11-95 (Ref. 30)	18
Fig. 8. D* vs bandgap and background temperature for photon detectors. Same source as Fig. 5, p. 11-97 (Ref. 31)	19
Fig. 9. System resolution comparison	21
Fig. 10. Multiaperture system response to a target at a particular location	21
Fig. 11. Matrix processing for multiaperture optical seekers	23
Fig. 12. A possible multiaperture configuration for GNAT	25
Fig. 13. A sandwiched pair of aluminized PVDF sheets, poled in opposing directions, bends as voltage is applied	29

GNAT--AN INFRARED HOMING ANTIPERSONNEL MICROMISSILE

by

Eugene H. Farnum

ABSTRACT

New technological discoveries make possible the development of a very small, terminally guided missile that could greatly increase the lethality of hand-held antipersonnel battlefield weapons. This missile could have a body diameter of only 20 mm (0.8 in.), a length of 100 mm (4 in.), and a weight of 90 g (~3 oz). It could be launched from a hand-held weapon similar to a rifle with ~100 m/s initial velocity or dropped from aircraft to seek out and attack human targets on the battlefield. The conceptual missile is powered by a small solid propellant rocket capable of sustaining flight at 100 m/s for >1-km range. The missile body and any fixed aerodynamic surfaces are made of injection-molded plastic. An infrared seeker, made with multi-apertures, cast, chalcogenide glass lenses, and thermoelectrically cooled thin film infrared (IR) detectors, has a human target acquisition range of ~50 m with a field of view of ~35 m. This allows a capture angle of $\pm 2^\circ$ at 500 m. The flight control and guidance system uses a miniaturized linear gyroscope and silicon chip micromechanical devices. A very large scale integrated (VLSI) circuit reads the IR sensors and supplies flight correction signals to aerodynamic steering surfaces. These steering surfaces are made of multilayer piezoelectric polymer bimorphs that bend by an amount proportional to an applied voltage. The warhead, which can weigh 1.5 oz, is conceptually a high-explosive/pellet type. Operating power is supplied by a polyacetylene battery which is formed into a tube and inserted as a liner for the missile case.

The missile is made of mass-produced modules that can be easily assembled without mechanical moving parts or adjustment. The modules include (1) the body with polyacetylene battery and piezoelectric polymer steering fins; (2) the integral seeker, guidance, and fuzing package; (3) the warhead; and (4) the rocket-assist motor.

Even though the IR seeker would only have limited background discrimination capability and would depend on a temperature difference between the target and background, it would be substantially more effective at hitting a human target than an assault rifle, requiring only approximate initial pointing. It would be

effective at night and in adverse weather against unprotected troops. This missile could dramatically reduce the cost/kill for battlefield troops. An airfield-dropped version need not have a rocket assist and could carry a larger (2-oz) warhead.

The following new technologies make this missile possible:

- Piezoelectric polymer multilayer bimorphs have been demonstrated and used as fans to cool electronic instruments. The material is available and the theory of operation is well understood. Development of an optimal adhesive and improvements in fabrication techniques are required.
- The IR seeker and guidance package would need substantial development effort, but the technology of multiaperture optical seekers, IR transmitting glasses, thin film IR detectors, silicon chip micromechanical accelerometers, and custom VLSI circuits is presently state of the art. Mechanical design of a miniaturized linear gyroscope must be demonstrated.
- Polyacetylene batteries represent an emerging technology but are not a critical part of the missile design. Currently available batteries would suffice.
- The missile body, warhead, and solid fuel rocket are current technology.

All these technologies are readily adaptable to automated mass production, assembly, and certification.

The concept originated in the Advanced Weapons Technology group at Los Alamos National Laboratory. Initial calculations show that all elements of the system are compatible with the intended mission and capable of being developed to adequate performance.

A 6.1 study to more fully explore the details of the concept, investigate potential materials, and identify problem areas would be the next logical step. A study to determine the sensor characteristics necessary for IR discrimination of soldiers on a battlefield would allow a more accurate cost/kill number and aid in preliminary design. However, this will be a low-cost, mass-produced missile, and high levels of discrimination are not required to achieve a favorable cost/benefit ratio.

I. INTRODUCTION

A. The Current State of Affairs

Self-guided (fire-and-forget) weapons are gradually replacing aimed and man-guided weapons in all aspects of modern warfare planning. This is primarily because they have a greater kill probability than more conventional weapons and offer a greater degree of protection (survivability) to the launch platform. In addition, the launch platform can engage more targets because it is freed from the need to follow the course of the weapon or observe the hit. The exception to the use of self-guided weapons is the infantry soldier.

Unarmored infantry troops are still a major force on most modern battlefields--certainly in the recurring third world conflicts and somewhat less so in the envisioned European conflict. Because of rapid automatic fire and tracer ammunition, the current infantry weapon (the M-16 assault rifle) cannot be called unguided at ranges up to 300 m, but it is certainly not self-guided. In fact, the assault rifle is notoriously ineffective in terms of the numbers of rounds fired or the cost per enemy soldier killed.¹ Other weapons for attacking unarmored infantry are designed to be released from smart weapons systems as submunitions. However, unlike the homing submunitions used for defeating armored vehicles, the antipersonnel submunitions are unguided bomblets or grenades, which blindly attempt an area kill using blast or small fragments. Clearly, a terminally guided, fire-and-forget, antipersonnel weapon could have as profound an effect on the nature of infantry combat as air-to-air heat-seeking missiles have had on aircraft combat.

The main reason that self-guided weapons, namely guided missiles, have not been developed for antipersonnel missions is that guided missiles are too large, too expensive, and insufficiently maneuverable for such a low-value, elusive target. The application of missiles to attack small, low-value targets requires small, low cost missiles. However, a guided missile has to have a mechanical steering control, a propulsion unit, a gyroscope or stabilization package, a target detection sensor, and a guidance computer. Mechanical steering typically uses hydraulics and is heavy. Stabilization usually employs sensitive gyroscopes and is expensive. A heavy, expensive missile must attack a valuable target, but valuable targets are encountered at long ranges and are usually large. Thus, the propulsion unit must be large with sufficient fuel for the needed range and the detection sensor must be large and sensitive enough to acquire the target at that range. Then, the warhead must be sufficiently large

to defeat the target when the missile has done its job. Finally, since this large missile is now also high value, more sophisticated guidance and control are justified to assure high reliability and high kill probability. As you can see in Fig. 1, a vicious circle develops which limits the minimum size of the missile and the minimum value of the intended target. What is needed to break this circle is a lightweight, compact steering technique; a low-cost stabilization package; a simple, cheap detector; and a miniaturized computer.

B. The New Technologies

Newly developed and emerging technologies allow solutions to these problems and an infrared (IR) homing, antipersonnel missile with a mass of <100 g is currently possible. It is my purpose, in this report, to propose a configuration for such a missile and to show that, by using current technology, an effective terminal-homing antipersonnel missile is feasible. The design of a missile system is a complex tradeoff between the desired mission, the performance of each subsystem relative to the whole, and the cost. I have made no attempt in this study to optimize the design nor do I wish to restrict its configuration to the one I have chosen. The choices I have made for the size and weight of the missile, its aerodynamic characteristics, and the desired performance of each subsystem are only loosely balanced with each other and with the assumed mission and are not meant to be more than an example of what is possible.

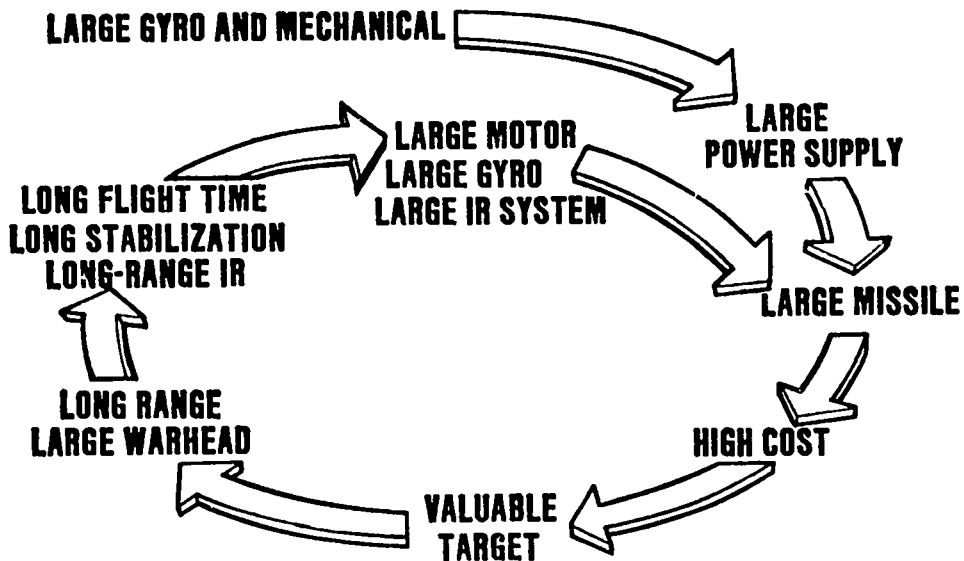

Fig. 1. The vicious circle leading to large missiles.

The missile, as shown in Fig. 2, would be steered by aerodynamic fins made of piezoelectric polymer or polymer/piezoelectric ceramic multimorphs. These devices are made by laminating layers of piezoelectric material so that adjacent layers are poled in opposing directions normal to the film plane. A voltage, applied to the stack, contracts the films on one side and expands those on the other side causing a bending of the stack similar to a bimetallic reed used in thermostat devices. The deflection can be much greater than the contraction or expansion of the individual sheets and, as will be shown below, the available force is adequate for this application.²⁻⁷ Piezoelectric multimorphs have been used as vibratory fans to cool electronic apparatus. The use of piezoelectric multimorphs for steering fins eliminates all mechanical components in the flight control and allows purely electronic guidance.

If straight-line flight is desired, the guidance and stabilization package must stabilize the missile until a target is acquired--a time of $\lesssim 10$ s. This can be accomplished by a miniaturized vibrating cylinder or vibrating rod linear gyroscope.⁸⁻¹⁵ Vibrating cylinder gyroscopes have been thoroughly studied and have been made in sizes only a few times larger than desired for our application.¹⁶ Some innovation would be needed to achieve the desired low cost, but smaller is generally cheaper and no technological impediments are apparent. Alternatively, a linear gyroscope similar to that used by the common house fly to control its altitude may be used.¹⁰ I will suggest below the use of a single crystal SiC fiber with a magnetic sphere attached to one end to make a microscopic linear gyroscope capable of short-term stabilization. The gyroscope can be complemented if necessary by miniature linear accelerometers made from single-crystal silicon wafers.^{17,18} Such devices use a new technology and are called micromechanical silicon devices.

Infrared detection and target acquisition would utilize thin film PbSe, PbS, or HgCdTe IR detectors mounted on thin film thermoelectric coolers if needed. The most efficient optical system is probably the multiaperture "fly's eye" technology, which uses a small number of lenses each with a small number of detectors with overlapping fields of view (FOV); seven lenses with seven detectors each have been used. Thin-film silicon detectors have already been made with adequate detectivity, and research is progressing rapidly on HgCdTe.¹⁹ IR-transmitting lenses of germanium or chalcogenide glasses²⁰ can be mass produced by simple molding processes. Multiaperture systems of the same size as needed for our application have already demonstrated sufficient resolution and have

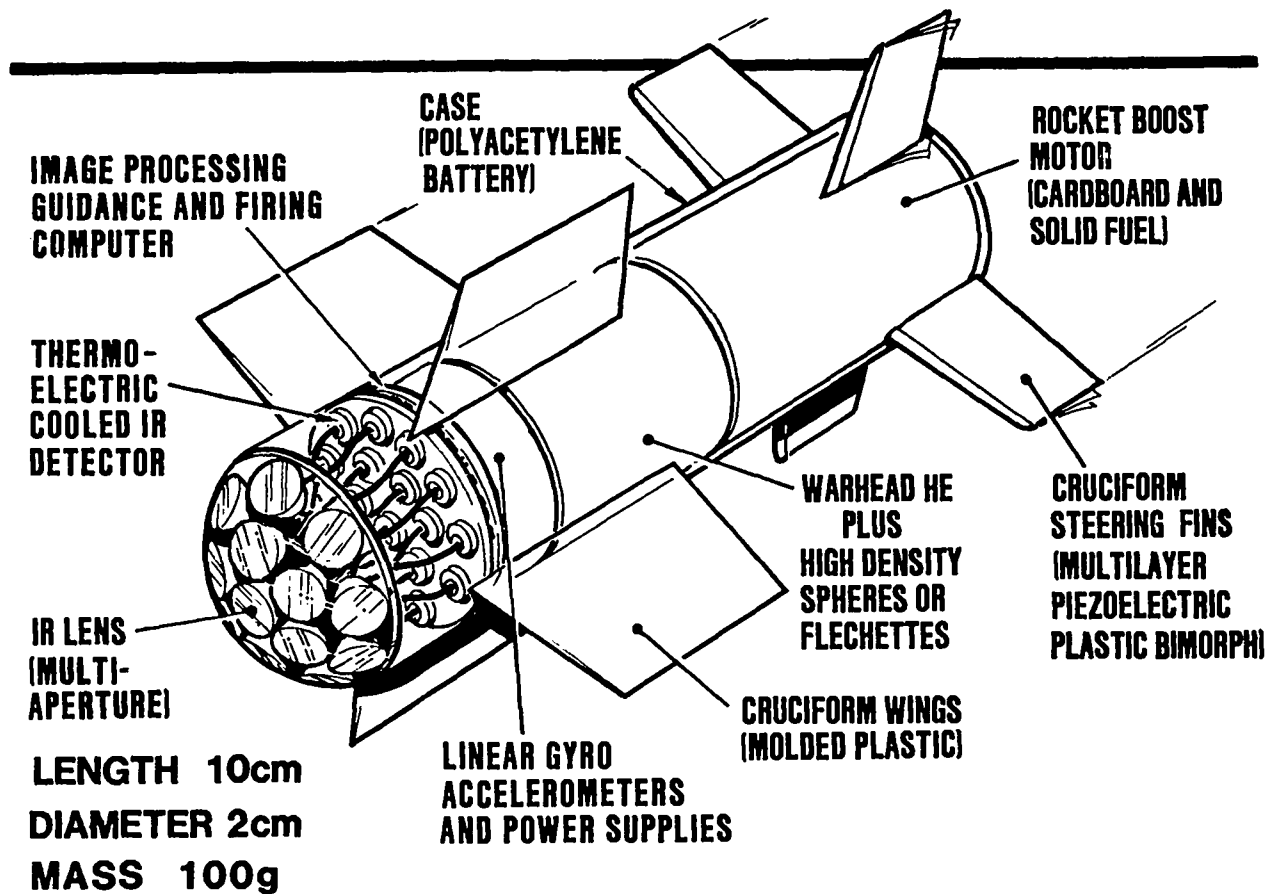

Fig. 2. Features of the GNAT--an IR homing antipersonnel micromissile.

generated steering commands for a homing system called Multiaperture Optical Thermal Homer (MOTH).²¹ A major advantage of such a system is that the number of detectors, and thus the required computing capacity for rapid image analysis, is within the capacity of VLSI circuit technology under development by the Defense Advanced Research Projects Agency (DARPA).

Considerable computer capacity is needed for the image processing, guidance and stabilization, and steering functions. In addition, several power supplies and other miscellaneous electronics will be needed for control, fuzing, and other desired functions. VLSI circuit technology can already put sufficient computer power on a single chip that is <1 cm on a side. Commercial computer chips are available with 256,000 random access memory in a few square millimeters.²² The entire electronics package could be designed as a single VLSI circuit chip using technology being developed in current DARPA programs. The power supply must be capable of a few watts for ~10 s and must have a long shelf life. Currently available lithium batteries have adequate size and power for this use.²³ Polyacetylene batteries are an emerging technology which also may prove useful.

The missile could be launched by airdrop or from a hand-held or machine-mounted launcher. A small, solid fuel rocket motor (similar to those used by model rocket hobbyists) would be used to maintain the desired velocity for the useful range (assumed to be ~1 km). It is also possible within the size and weight limitations used in my example to increase initial rocket thrust sufficiently to allow a recoilless launch.

The missile used in this example can carry a 1- to 2-oz (30- to 60-g) warhead. The envisioned warhead would be a cylinder of close-packed tungsten spheres surrounding ~10 g of high explosive. This warhead would weigh ~1.5 oz (46 g). Although more innovative concepts may be developed for the warhead, this example has more propellant and about the same shot weight as a 12-gauge shotgun shell. It will be more than sufficient for a contact kill and will probably have a kill radius of a few feet.

In the discussion below, I will expand on these ideas to show that the performance of each part of the system is adequate and then discuss the currently available technology. However, we must first develop an intended mission, show that the missile could be cost effective, define the nominal target, and develop design criteria.

II. OPERATIONAL ANALYSIS

A. The Mission

The purpose of the proposed missile is to attack unmounted infantry personnel. Usually these personnel will also be unarmored except for battle dress, which may include lightweight body armor. The battlefield may be anywhere, but the mission is intentionally limited to situations in which there is some measurable difference between the target and the background. That is, where an IR detector is used the target must be either hotter or colder than the background. The background threshold temperature will be determined by that temperature which includes most of the signals received from "hot rocks" or false targets. The number of false targets allowed above the background threshold temperature affects the probability of hitting the intended target and will be determined by the cost of the missile. If the missile can be made very cheaply, it will be reasonable to attack every hot object on the battlefield knowing that a fraction of these hot objects will be desired targets. Obviously, there will be situations where human targets are indistinguishable from the background with IR detection and the missile will not be useful. Such situations can be determined in advance and detailed in the User's Manual.

B. Launch Options

The missile may be launched in different ways, depending on the desired mission. It may be dropped by aircraft over enemy troops and follow a spiral descent while searching for a target. It may be dropped similarly by a dispenser as a smart submunition. Using its own propulsion, it may be fired from a hand-held weapon in the direction of a potential target or it may be fired in salvo from a motor-driven platform. The trajectory between launch and target acquisition may be a straight line of sight, a ballistic path, or some more complicated path. The latter may be preprogrammed or programmed at time of fire to attack targets hidden from view. Similarly, a range-set would be an easy addition. With an uncooled detector, the missile may be prepositioned to "watch" a jungle trail or urban street and launch itself at any detected target within its acquisition range.

C. Cost Effectiveness

The foremost operational analysis questions are, "What is the cost per kill vs the target value? What are the alternative weapons?" Alternative weapons include bomblet submunitions, machine gun fire, and the M-16 assault rifle. The cost per kill of these weapons is difficult to obtain, but in the

Vietnam conflict the cost of M-16 ammunition exceeded \$5000 per casualty inflicted.¹ Figure 3 shows the number of rounds fired by infantry rifles vs casualties inflicted for some Twentieth Century conflicts. The M-16 ammunition (5.56-mm NATO) weighs 12.5 g and has a volume of $\sim 4 \text{ cm}^3$. If the missile were ~ 100 times more effective at hitting a target at 100 g and a volume of 30 cm^3 , it would be about 10 times more effective for logistics support (weight and volume) than the M-16. There is obviously a lot of room for improvement in this area and the size and weight of the proposed missile are well within the range of acceptable effectiveness. Nevertheless, we must constantly keep in mind the delicate balance that determines cost effectiveness and the vicious circle of missile size described in Fig. 1.

D. The Nominal Target

A typical human being at rest generates about 100 W of heat from metabolic processes. This heat is rejected from the body by radiation and convection from exposed surfaces, by transfer to the air in breathing and, if necessary, by evaporative cooling (perspiration). Metabolic heat output increases with increasing activity, and the body attempts to regulate its temperature by raising skin temperature and perspiring. Since the body cannot raise the skin temperature above 310 K (98.6°F), perspiration takes over in warm conditions. In cold conditions skin temperature decreases as the body tries to preserve heat. This decrease is limited since temperatures of less than 299 K (79°F) become uncomfortable and require clothing to reduce the radiating area. Let us try to make a typical (average, nominal, or guessed) case by assuming that the body generates 100 W, that it rejects this heat over the entire 2 m^2 of body area, and that 60% of the cooling is by perspiration, convection, and breathing. In this case the radiated heat is 21 W/m^2 . With an emissivity of 0.8, this corresponds to a temperature difference of 4 K at a radiating temperature of 300 K. Thus, for a background of 304 K (88°F), the skin temperature will be 308 K (95°F). Note that this is quite a conservative estimate and that temperature differences between skin and background of more than 10 K are not unusual. The ideal blackbody emission at 308 and 304 K in various spectral regions is shown in Table I.

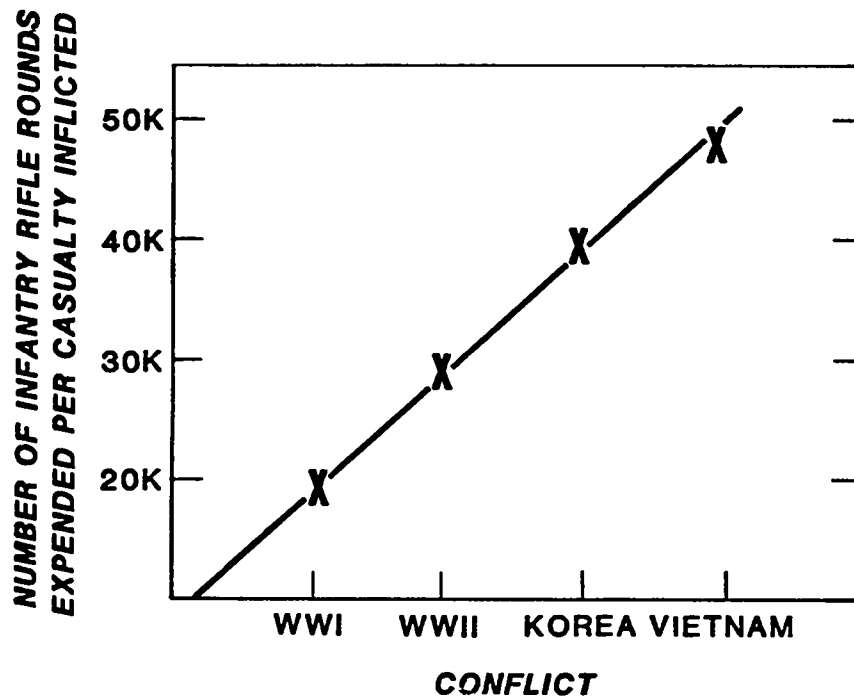

Fig. 3. Number of rounds fired by infantry rifles per enemy casualty inflicted for recent United States conflicts.

TABLE I

BLACKBODY RADIATION FOR A TARGET AND BACKGROUND
IN SEVERAL WAVELENGTH BANDS

Wavelength Range (μm)	Target Emitted Flux at 308 K (W/m^2)	Background Emitted Flux at 304 K (W/m^2)	Net Emitted Flux (W/m^2)
All	510.0	484.0	26.0
8.5-12.5	132.0	124.0	8.0
8-9	34.3	32.0	2.3
9-10	35.0	32.8	2.2
3.4-4.8	3.9	4.5	0.6
1.8-2.8	25×10^{-2}	1.9×10^{-2}	6×10^{-3}

Atmospheric transmission bands at 8.5 to 12.5 (the 8- to 12- μm band) and 3.4 to 4.8 μm (the 3- to 5- μm band) are commonly used for IR detection to avoid atmospheric absorption.

Thus we expect a person, in rejecting his 100 W of heat, to radiate a net flux of 0.6 W/m^2 in the 3- to 5- μm band and 8 W/m^2 in the 8- to 12- μm band.

The background temperature of 304 K taken for this typical case will correspond to the background threshold temperature discussed earlier. Possible battlefields can have average temperatures between 253 and 315 K (-5 to +107°F) and will make target detection more or less easy respectively. Attempts to model carefully controlled backgrounds²⁴ have been relatively successful. For example, a field of grass can be described by an effective blackbody temperature, T_e , different from the temperature of the air, T_{air} , which is given by

$$T_e = -14.3 + 1.6 T_{\text{air}} ,$$

where temperatures are in degrees centigrade. This does not account for reflected solar radiation, hot rocks, and metal surfaces. Reflected solar radiation can be significant in the IR but the reflectance of the target and the average background are both low and probably about the same (~10%). Hot rocks and metal surfaces can obviously pose a discrimination problem for a nonimaging IR system on a warm sunny day. I believe that the usefulness of this proposed missile under such conditions must be determined experimentally with prototype systems. In addition, these conditions, least favorable for good IR detection, are also most favorable for alternative weapons, such as the M-16 rifle.

III. CURRENT DESIGN CRITERIA

To demonstrate that technology is adequate to make an effective missile, some design parameters must be specified. I have selected the target characteristics and background for a "typical" scenario. Performance characteristics necessary to make the missile a cost-effective addition to the antipersonnel arsenal must also be selected before even a preliminary design can be attempted.

I have taken the case of a missile fired from a hand-held weapon at a target 500 m away. The shooter is assumed to be able to point his weapon within $\pm 2^\circ$ of the location of the target at missile arrival (a full-choke shotgun with a range of 50 m, requires pointing $\pm 0.6^\circ$). A field of view (FOV) of $\pm 2^\circ$ at 500 m is 32 m diam. If the missile cannot acquire the target at 500 m, the FOV

must still be 32 m diam at the acquisition distance. Thus, the optical FOV depends on the acquisition distance, which in turn depends on the detector sensitivity. However, it does no good to have the FOV cover an area larger than the missile's ability to turn and attack. The minimum turning radius of the missile is determined by the maximum aerodynamic force that can be exerted by the steering surfaces and on the air speed. The minimum turning radius also depends on wing area, aerodynamic design, missile mass, and moment of inertia; however, the steering force possible with piezoelectric bimorphs is limiting for our case. Thus, the limitations of detector acquisition distance and aerodynamic steering force are interdependent in the missile design, and both determine the available FOV and airspeed.

The missile could cover more area and have a larger FOV with a slow speed and large wings. However, in addition to the limitation on missile (and thus wing) size imposed by our desire to minimize cost, the missile must be sufficiently fast so that the target cannot detect the attack and evade it. A person observing a missile coming toward him can either shield himself or remove himself from the FOV. Typical eye-hand reaction time is 0.2 s, so it is conceivable that a person could shield themselves in 0.5 s. They could not move 16 m out of the FOV in that short a time. Since the proposed 2-cm-diam missile will become visible against a good background at a range of 30 to 50 m, an airspeed of 100 m/s should be adequate for the missile to be effective.²⁵

This speed is also consistent with the wing area and turning radius desired. A number of discussions have suggested that it may be desirable for a soldier to be able to avoid the missile if he sees it coming soon enough. These arguments are based on distractive and psychological advantages; further consideration of this point will be left to strategists and the interested reader, since there is no reason why the missile speed could not be reduced or increased within limitations discussed below.

Finally, the warhead must be sufficient to kill the target. A 100-g missile traveling at 100 m/s would probably kill a person without a warhead if it hit a vulnerable spot. Since the soldier may be surrounded by other hot objects, which may decoy the missile, such as his rifle or a pile of just-fired cases, a kill radius of ~1 m for the warhead is preferred.

The criteria adopted for the missile proposed herein are based on a scenario which may not have much relevance to the mission envisioned by the reader.

It will be the task of the reader, skilled in the art of combat and with experience which shows him where such a missile is needed, to define criteria for his desired mission.

IV. TARGET DETECTION

A. Detectors

The limit to maximizing the target acquisition distance is the sensitivity of and noise in the IR detector. Sensitivity is generally represented by a parameter called the detectivity or D^* , expressed in units of $\text{cm Hz}^{1/2} \text{W}^{-1}$, which depends on the detector material, the material purity, the care taken in detector design, and the detector temperature. The detectivity also depends on parameters of the electro-optical system, such as wavelength band, integration time (or the inverse called flicker frequency), and background temperature. Carefully designed detectors can have total noise limited by background variations. In the case of photon detectors (probably the best choice for this application), this type of detector is called a Background Limited Infrared Photodetector (BLIP), and its detectivity, D^*_{BLIP} , can be determined for a specific wavelength, λ_{peak} , integration time, t , bandwidth, $\Delta\lambda$, and background temperature, T_b . It can be shown from first principles of detector physics that the noise equivalent power on a detector array from an optical system is given by

$$\text{NEP} = \frac{f\phi}{D^*} \sqrt{\frac{\Omega}{2Nt}} \quad , \quad (1)$$

where

f is the ratio of focal length to diameter of the lens system,

ϕ is the lens diameter,

Ω is the solid angle of the FOV,

N is the number of detectors,

D^* is the detectivity of a single detector for the conditions of interest,
and

t is the integration time (sometimes called frame time).

The ratio of the power radiated by the target that falls on the lens to the NEP is the signal-to-noise ratio (SNR) of the detection system. The distance

from the target for which SNR = 1 will be called the acquisition range, although there is reason to believe that multiaperture systems can do somewhat better, as will be discussed below.

Infrared detectors are commercially available²⁶ for both the 3- to 5- μm and the 8- to 12- μm bands. These are available in packages as small as 4.7-mm-diam transistor cans, as shown in Fig. 4. They can be supplied with two-stage thermoelectric coolers, capable of detector operations below 230 K with only a few watts electrical cooling power. Examples of commercial detector performance are shown in Figs. 5 and 6. The 8- to 12- μm band will use $\text{Hg}_{1-x}\text{Cd}_x\text{Te}$ detectors, while the 3- to 5- μm band is best served by PbSe detectors. Detectivities of the order of $10^{10} \text{ cm Hz}^{\frac{1}{2}} \text{ W}^{-1}$ appear to be the present state of the art although theoretical values are higher.²⁷

It will probably be necessary to cool the detectors to achieve the desired detectivity, especially in the 8- to 12- μm band. Figure 7 shows the maximum temperature for BLIP operation as a function of background photon flux. For the 8- to 12- μm band, temperatures of ~ 120 K are needed for BLIP operation. If BLIP operation is achieved, the detectivity can be $> 10^{10} \text{ cm Hz}^{\frac{1}{2}} \text{ W}^{-1}$ for a 300 K background temperature, as shown in Fig. 8. The detectivity also falls off for long integration times because of an elusive $1/f$ noise associated with all detectors.

In summary, the following represents the current state-of-the-art in photon detectors for the IR when observing a 300 K background.

3- to 5- μm band--detector temperature < 250 K

frame frequency $\gtrsim 300$ Hz

material - PbSe

detectivity $D^* = 10^{10} \text{ cm Hz}^{\frac{1}{2}} \text{ W}^{-1}$

theoretical limit $D^* = \sim 2 \times 10^{11} \text{ cm Hz}^{\frac{1}{2}} \text{ W}^{-1}$

8- to 12- μm band--detector temperature < 150 K

frame frequency $\gtrsim 300$ Hz

material - $\text{Hg}_{1-x}\text{Cd}_x\text{Te}$

detectivity $D^* = 5 \times 10^9 \text{ cm Hz}^{\frac{1}{2}} \text{ W}^{-1}$

theoretical limit $D^* = \sim 3 \times 10^{10} \text{ cm Hz}^{\frac{1}{2}} \text{ W}^{-1}$

Cooling may be achieved rather easily by thermoelectric coolers or by micro-sized Joule-Thompson refrigerators, and if detectivities of $10^{10} \text{ cm Hz}^{\frac{1}{2}} \text{ W}^{-1}$ are needed, some detector cooling will be required.

SPECIAL FEATURES

**PEAK SENSITIVITY COMPARABLE TO DEVICES
OPERATING AT 77° K**

THERMOELECTRICALLY COOLED

PROVEN SOLID STATE STABILITY

HERMETICALLY SEALED

RUGGED, COMPACT

IMMEDIATE DELIVERY

LOW COST

BRIEF DESCRIPTION

OTC-12-5 series infrared sensors are OPTOELECTRONICS, Inc. lead selenide (PbSe) detectors mounted on two stage thermoelectric coolers and packaged in TO-5 cans.

Designed for use in applications requiring detectors with extremely high sensitivity in the $1\mu\text{m}$ to $5\mu\text{m}$ spectral region, these sensors offer an economical means for obtaining cooled photoconductive detector performance without the bulk and inconvenience of liquid cooling.

OTC-12-5 detector packages are fully evacuated and hermetically sealed, incorporating advanced packaging concepts such as all fused and welded construction; in addition, the PbSe detector elements in these sensors are fully passivated with a protective overcoat. This passivation technique, developed by OPTOELECTRONICS, Inc., eliminates instabilities generally associated with PbSe detectors when they are subjected to visible and/or ultraviolet radiation.

Particularly suitable for use in high volume, low cost systems operating in the $1\mu\text{m}$ to $5\mu\text{m}$ spectral region, OTC-12 series detectors provide peak sensitivity, comparable to liquid nitrogen cooled (77°K) PbSe, and performance and reliability far exceeding that of any other previously available photo-detector of comparable size and cost.

Various standard heat sinks (optional), including a TO-37 mounting base, are available for use with these detectors.

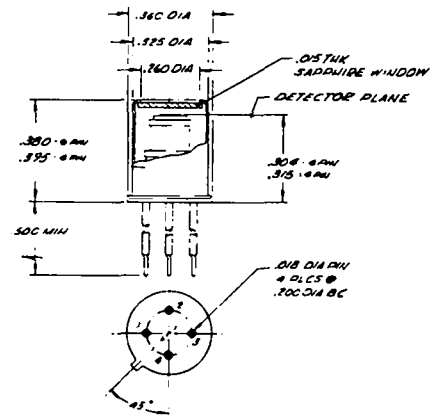

UNITS WITH THERMISTORS (OPTIONAL)

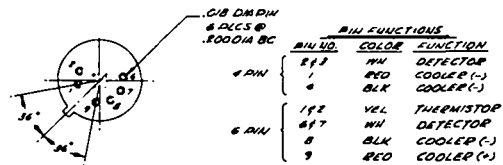
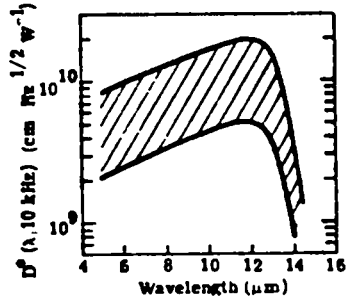

Fig. 4. Example of a commercial thermoelectrically cooled PbSe IR detector. Reprinted with permission from the 1983 Catalog of Optoelectronics Inc., Petaluma, California.

$\text{Hg}_{1-x}\text{Cd}_x\text{Te}$

$T_d = 77 \text{ K}$
 $A_d = 4 \times 10^{-6} \text{ to } 4 \times 10^{-2} \text{ cm}^2$
 $R_d = 30 \text{ to } 800 \text{ ohms}$
 $\tau = 100 \text{ to } 800 \text{ nsec}$
 $\text{FOV} = 10^\circ \text{ to } 130^\circ$
 $\text{Background temperature} = 300 \text{ K}$
 $\lambda_p = 10^4 \text{ V W}^{-1}$
 $\lambda_p / \lambda_{bb} = 2$



(a) Spectral response of detector D^* ($\lambda, 10 \text{ kHz}$).

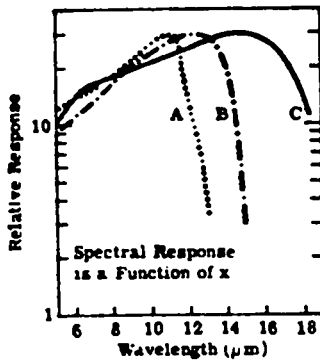

(b) Spectral response of detector responsivity. Curve A: $x = 0.21$; Curve B: $x = 0.20$; Curve C: $x = 0.17$.

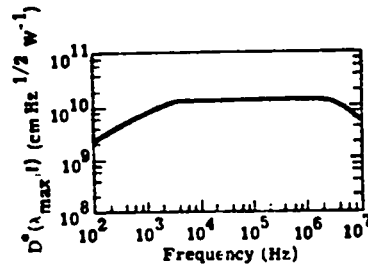

(c) Frequency response of detector D^* (λ_p, f).

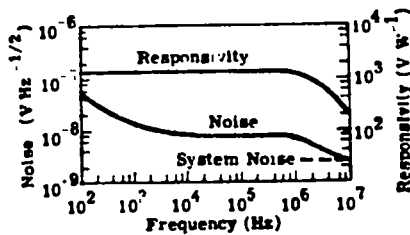

(d) Frequency response of detector noise.

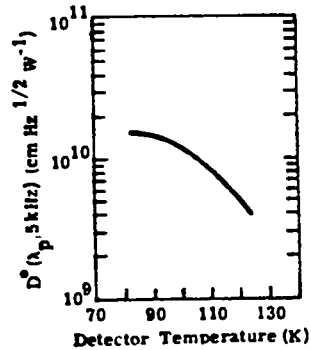

(e) Temperature of detector D^* ($\lambda_p, 5 \text{ Hz}$).

Note

Spectral response is determined by the alloy composition.

Fig. 5. $\text{Hg}_{1-x}\text{Cd}_x\text{Te}$ detector performance data at 77 K.
 "Performance of commercial photon detectors" from
 Refs. 27 and 28.

PbSe

$T_d = 145 \text{ to } 250 \text{ K}$
 $A_d = 25 \times 10^{-6} \text{ to } 1 \text{ cm}^2$
 $R_d = 2 \text{ to } 100 \text{ mehoims}$
 $\tau = 10 \text{ to } 1000 \text{ } \mu\text{scc}$
 $\text{FOV} = 2\pi\text{sr}$
 $\text{Background temperature} = 300 \text{ K}$
 $\frac{R_{\lambda_p}}{R_{\lambda_p}} \approx 10^5 \text{ V W}^{-1}$
 $\frac{R_{\lambda_p}}{R_{\lambda_p}} \approx 5$

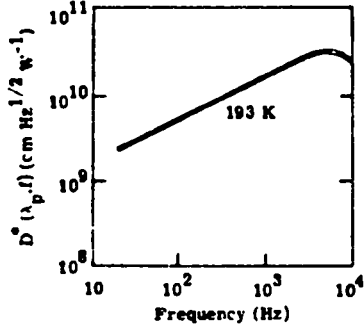

(a) Frequency response of detector D^* (λ_p, f).

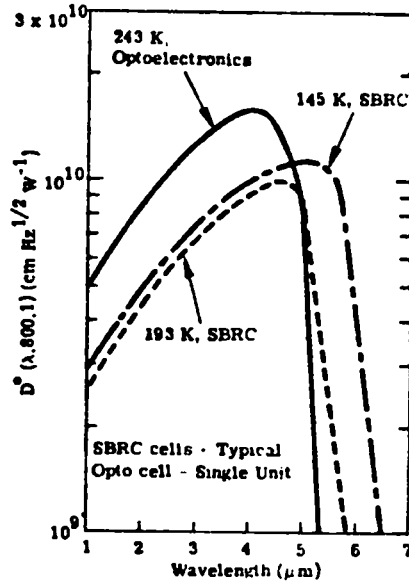

(b) Spectral response of detector D^* ($\lambda, 800, l$).

Note

- (1) An operating temperature may be selected in the 145 to 250 K range. Thermoelectric coolers can be used. Known manufacturers are SBRC and Optoelectronics.
- (2) This range is for square configurations. The resistance will vary according to the l/w ratio.

Fig. 6. PbSe detector performance data at 145 to 250 K. Same source as Fig. 5, p. 11-73 (Ref. 29).

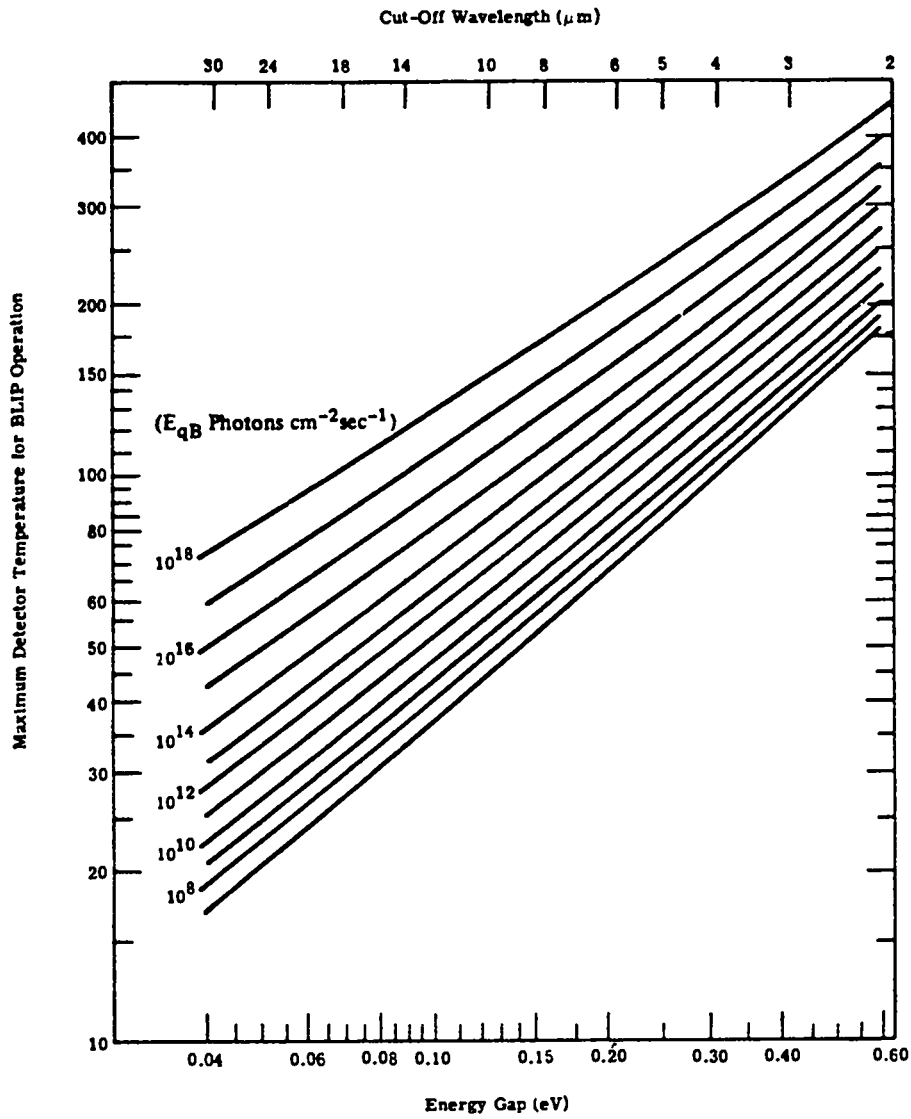

Fig. 7. Maximum detector temperature for BLIP Operation vs energy gap for photon detectors. Same source as Fig. 5, p. 11-95 (Ref. 30).

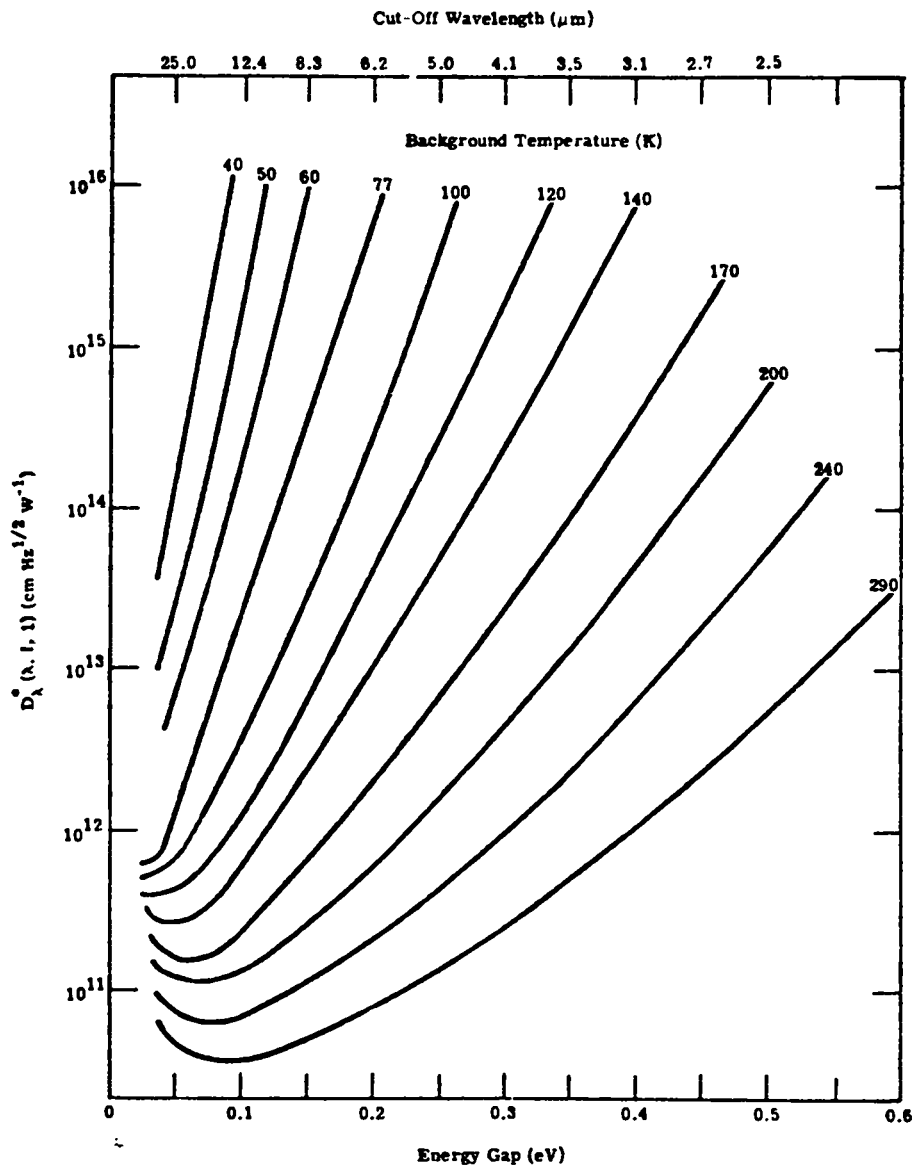

Fig. 8. D^* vs bandgap and background temperature for photon detectors. Same source as Fig. 5, p. 11-97 (Ref. 31).

B. Single-Aperture Optical Systems

The conventional approach to seeker design requires that we divide the overall FOV into resolution elements, or pixels, so that the far-field target fills one pixel. A 20- by 20-cm target on a 33- × 33-m background thus requires a focal plane array (FPA) of 165 × 165 elements (total 27,275). Arrays of this size have been fabricated for research programs, but the percentage of faulty detectors and nonuniformity in gain between detectors are still major problems. Mechanically scanned systems can eliminate the nonuniformity problem with increased system complexity, but are too large and expensive for this application.

Another drawback to these systems is the need for extensive signal processing. To process 100 frames/s, 2.7×10^6 samples/s must be read and digitized (assuming full FOV processing). The digitized data must then be processed to adjust for variations in detector gain, subtract background, and locate target centroids. This requires between $3N$ and N^2 computer operations. Disregarding the A/D conversion process, the total load before tracking algorithms are applied is at least 10^7 floating point operations/s (FLOPS). The processor thus requires instruction times of 100 ns and cycle times of <10 ns. Such processors exist and may ultimately be available at low cost; however, the complexity of the FPA system and its present high costs make its use for this application beyond the state of the art. Fortunately, there is an alternate approach.

C. Multiperture Optical Systems

A seeker system, based on the operating principles of the insect eye, has been demonstrated by the University of Florida under contract to the Air Force.²¹ Multiple 1-mm-diam lenses and arrays were used in a nonimaging technique to provide resolution, signal-to-noise, and processing speed improvements over much larger FPA systems. Pixels are much larger than the desired resolution element but, as shown in Fig. 9, fewer pixels are needed for the same resolution. Resolution is not constant over the FOV, but is much higher than the pixel size would normally allow. Since the FOV of each lens overlaps that of the other lenses, the detectors behind each lens have FOVs which overlap that of other detectors. With this scheme, no gaps are created in the FOV by detector interspacing. Kellogg³² has shown that if all resolved pixels are the same size and have the same degree of overlap, resolution improves by the square root of the number of apertures. The detected target signature, shown in Fig. 10, is a vector whose elements are the individual detector responses for the particular detected target.

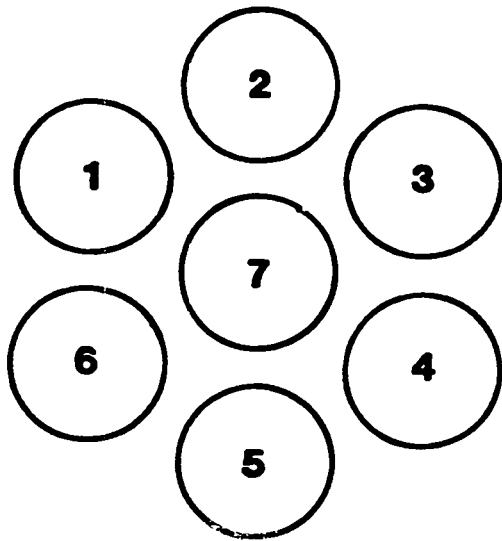

Focal Plane Array
 Seven detectors, seven resolved pixels. Gaps in coverage.

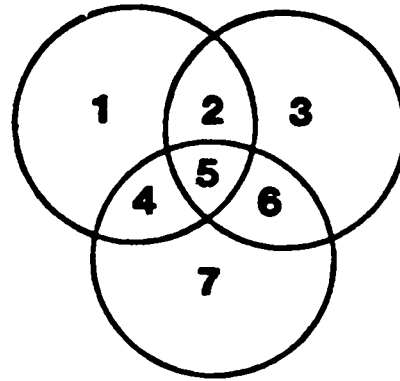

Multiaperture
 Three detectors, seven resolved pixels. No gaps in coverage.

Fig. 9. System resolution comparison.

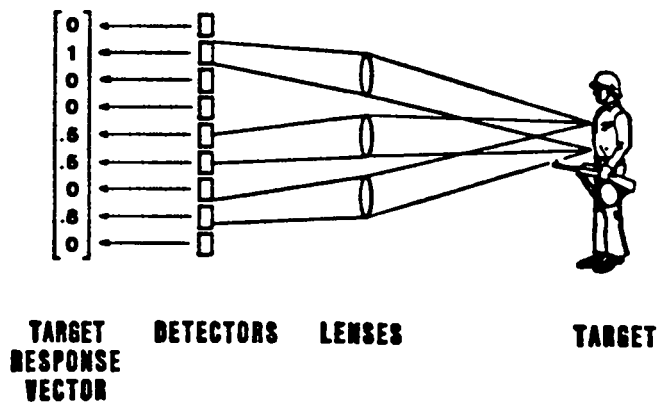

Fig. 10. Multiaperture system response to a target at a particular location.

The response vector is a list of the output voltage from each detector for a particular visual scene.

Just as an insect cannot image and comprehend the world around it, the multiaperture system cannot image the target and identify it. By prerecording

the detector response vector for each of a series of potential targets distributed over the FOV, we build a catalog of response vectors for the target space. This catalog already includes irregularities in the detectors, and eliminates the need to provide compensation when the target is acquired. Two methods of processing the catalog have been demonstrated. First, if the SNR of an actual target is large enough, the position of the target in the FOV can be found by comparing the target's response vector with the catalog of stored vectors. With interpolation, positional resolution of 0.5 mrad in a 60° FOV with only 49 detectors has been demonstrated.³³ Target rotational orientation was also easily discerned. Secondly, if the SNR is not sufficient, a more complicated but more sensitive method may be used. The catalog of response vectors forms a matrix, as shown in Fig. 11a, consisting of N potential-target-position vectors from M detectors, which can be inverted using nonsquare semispase techniques.³⁴ The resultant inverse matrix, called A^{-1} , is a list of coefficients for a least-squares average of the detector responses for the potential target positions. When the response vector of an unknown target location is multiplied by the inverse matrix, the resultant vector consists of a probability distribution for the target being at one of the prelearned potential target positions, as shown in Fig. 11b.

Target positions between, or even outside, the prelearned positions can be found accurately by interpolation. Since the target response vector and the A^{-1} matrix are multiplied row by row, the rows may be processed in parallel for increased speed if needed.

Using this technique with a 7-lens, 49-detector, 58° FOV system, Schrock³⁵ demonstrated target acquisition at SNR = 0.05 and tracking at SNR = 0.2.

The potential-target-position teaching and matrix inversion process is performed during seeker manufacture and stored in the VLSI circuit read-only memory (ROM). A 49-detector, 20-prelearned-location system, operating at 300 Hz requires only 6×10^5 FLOPS without any parallel processing. This may be compared to the $>10^7$ FLOPS required by a focal plane array with equivalent homing capability. This technique is also relatively insensitive to failures or damage to individual components in either the optical, detector, or processor subsystems. In addition, the teaching process can provide multicolor operation,

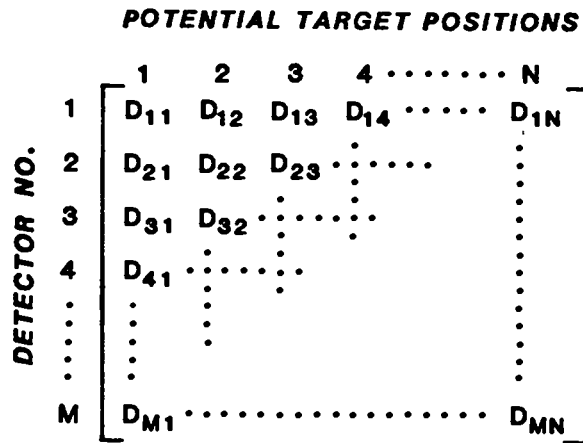

A

(a)

Matrix of responses from each detector for each potential target position.

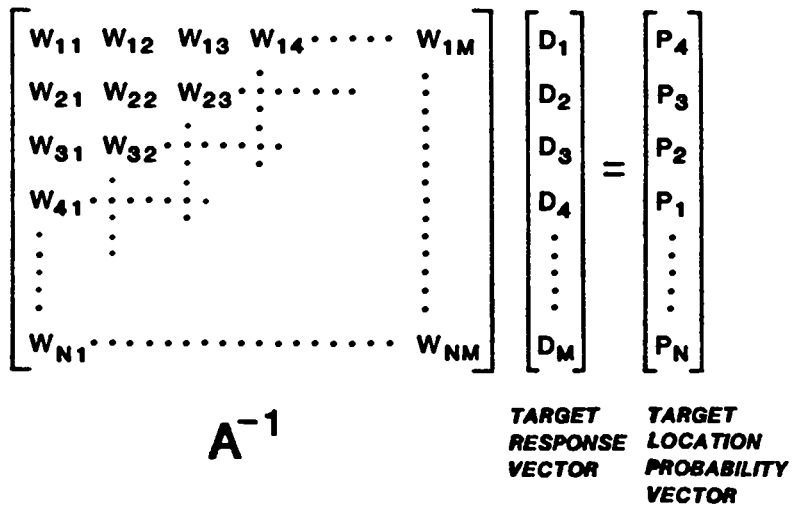

(b)

Inverse matrix times target response vector yields target location probability vector.

Fig. 11. Matrix processing for multiaperture optical seekers.

automatic steering gain change and center weighting if desired. With storage requirements of ~ 1.6 k bit, this system should easily fit on a single VLSI circuit chip. Current technology permits 256k bits on a 1-cm^2 chip.²²

This argument is not meant to imply that multiaperture systems are without disadvantage. Teaching a system too many locations rapidly increases the in-flight processing requirements and tends to reduce resolution. Thus, TV-type pictures are not practical. For similar reasons, a large density of targets in the FOV may give overlapping response vectors which cannot be discriminated. Overlapping FOV techniques were not discovered until 1979 and further studies on the effects of overlap, detector spacing, lens spacing, and matrix inversion are needed prior to packaging the design onto a single chip. However, Laboratory systems have already demonstrated resolution, FOV and SNR capabilities which exceed our basic requirements.

A possible configuration for the antipersonnel missile seeker system is shown in Fig. 12. Six or seven 6.7-mm-diam lenses will fit within the 2 cm diam allowed for this example. Each lens can have seven 2-mm-diam detectors. Individual preamplifiers and A/D converters for each detector, and parallel processing for the target location determination are used because space and cost are not prohibitive.

D. Target Acquisition Range

We are now able to define a target acquisition system and determine acquisition range. If the flux radiated by a target in the detectable wavelength band is P_t (W/m^2), then at a range R , the power from the target received at the detector, $P_d(W)$, will be given by

$$P_d = \frac{P_t A_t A_l}{4\pi R^2} \quad , \quad (2)$$

where A_t is the area of the radiating target and A_l is the collecting area of the lens. I have assumed that $R^2 \gg A_t$. For a $\text{SNR} = 1$, P_d equals the noise equivalent power (NEP) at the detector as given by Eq. (1) (pg. 13). The solid angle FOV (Ω), in Eq. (1) is the area of the desired FOV (πr^2), divided by the range squared, or $\Omega = \pi r^2/R^2$.

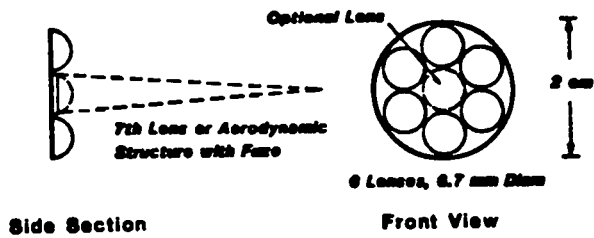

Fig. 12a. Lens subsystem.

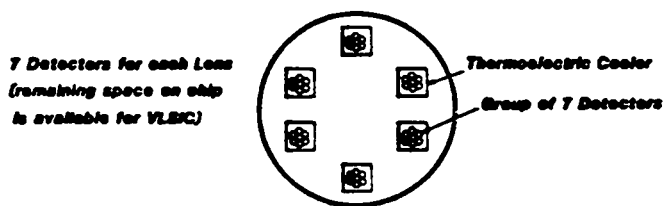

Fig. 12b. Detector subsystem, seven detectors for each lens (remaining space is available for VLSI circuit).

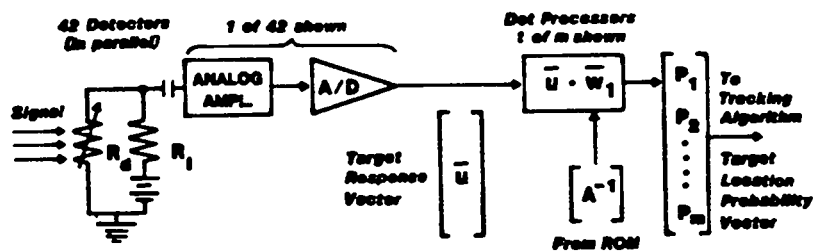

Fig. 12c. Signal processing subsystem.

Equations (1) and (2) yield an expression for the acquisition range where SNR = 1.

$$R = \frac{P_t A_t \phi D^*}{4fr} \sqrt{\frac{2Nt}{\pi}}, \quad (3)$$

where P_t = flux radiated by the target less the background flux in the wavelength band of interest,

A_t = radiating area of the target,

ϕ = effective collecting lens diameter,

D^* = detector defectivity for the wavelength band, background temperature, detector temperature, and frame time used,

f = ratio of the focal length to diameter of the collecting lens,

r = radius of the desired FOV,

N = number of detector elements which share the collected background power, and

t = integration or frame time (the inverse of flicker frequency).

The multiaperture optical system described above, has six 6.7-mm-diam lenses, each with seven detectors. The total collecting power of the six lenses is equal to a single lens with a diameter of 1.63 cm. However, the noise at each detector comes from its individual lens. The six lenses act together to make SNR < 1 possible. For the purpose here, I will treat only one lens element and still, conservatively, assume that SNR = 1; therefore, $\phi = 0.67$ cm. The number of detectors is seven ($N = 7$). The f number of the lens should be as small as practical and, since lenses are available, $f = 0.8$ is a reasonable value for this example. To stay conservative, I will take the target area to be only the human facial area or ~ 20 cm square ($A_t = 400 \text{ cm}^2$). As mentioned previously, defectivity $D^* = 10^{10} \text{ cm Hz}^{1/2} \text{ W}^{-1}$ for the 3- to 5- μm band and $D^* = 5 \times 10^9 \text{ cm Hz}^{1/2} \text{ W}^{-1}$ for the 8- to 12- μm band. The radius of the FOV is determined by the design criteria as 16 m, so $r = 1.6 \times 10^3$ cm. The integration time will be a compromise between the desired response time for the missile, the maximum defectivity, and the maximum acquisition range. A flicker frequency of 300 Hz is needed for maximum D^* and this is more than adequate for missile response. At a speed of 100 m/s, this is an update on target position three times per meter of travel. Thus, $t = 1/300 \text{ Hz} = 3.3 \times 10^{-3} \text{ s}$.

The acquisition range, R, can now be calculated using Eq. (3) and the parameters $\phi = 0.67$ cm; $N = 7$; $t = 3.33 \times 10^{-3}$ s; $f = 0.8$; $A_t = 400$ cm²; $r = 1.6 \times 10^3$ cm. This is tabulated in Table II. Thus the acquisition distance will be at least 38 m in the 3- to 5- μ m band and 260 m in the 8- to 12- μ m band. A D^* of 1×10^9 is possible in the 8- to 12- μ m band at higher detector temperatures, which is advantageous, and still gives an acquisition distance of 51 m. The higher detector temperature is a wise choice and, for the purposes of the remaining missile design, I have assumed that the acquisition distance is 50 m. Thus, either the 3- to 5- μ m or the 8- to 12- μ m band, or a combination of both for two color detection can be used with a similar estimate for the acquisition distance.

The 32-m-diam FOV at 50 m is an included angle of $\sim 36^\circ$. This FOV must be imaged onto the seven detectors in a compact and simple way. I have used a lens with $f = 0.8$ (N.A. = 0.65) in the above calculations because such lenses are easily available and the design of a custom lens is too difficult to attempt for this example. However, since high resolution is not needed and long wavelengths are being used, simple cast or pressed lenses without polishing or optical finishing can be used. Some antireflection coating and/or waveband filter coating may be desirable.

TABLE II
TARGET ACQUISITION RANGE FOR STATE-OF-THE-ART DETECTORS

IR Band (μ m)	D^* (cm Hz ^{1/2} W ⁻¹)	P_t^a (W/cm ²)	R (cm)
3 to 5	10^{10}	6×10^{-5}	3.8×10^3
8 to 12	5×10^9	8×10^{-4}	2.6×10^4
8 to 12	10^9	8×10^{-4}	5.1×10^3

^aSee Table I, p. 10.

V. GUIDANCE AND FLIGHT CONTROL

A. Piezoelectric Bimorphs

Piezoelectric bimorphs for aerodynamic steering control assure the low cost, size, and complexity of this missile. Piezoelectric bimorphs are made by laminating two or more sheets of piezoelectric film in which the polarities are normal to the film plane and opposite to each other. An applied voltage will contract one set of films and expand the other to produce a bending movement as shown in Fig. 13. These devices were first proposed for fans to cool electronic equipment^{3,4} and, although bimorphs are not yet in production (October 1983), the metallized film is available and custom devices can be obtained commercially.³⁶

The amount of force and deflection of a bimorph stack depends on the number of layer pairs (N), the thickness of each film (t), the applied voltage (V), the width (w), the length (ℓ) of the bimorph, the piezoelectric coupling coefficient (d_{31}), and the Young's modulus (Y). The maximum voltage is determined by the product of the dielectric strength (ϵ) and the film thickness. The maximum force at no displacement (F_{\max}) is given by

$$F_{\max} = \frac{3Ywd_{31}N^2t^2\epsilon}{2\ell} \quad (4)$$

and the maximum displacement for no force (D_{\max}) is given by

$$D_{\max} = \frac{3\epsilon d_{31}\ell^2}{4Nt} \quad (5)$$

As can be seen from Eqs. (4) and (5), the parameters open to design (w , ℓ , N , and t) are inversely related to force and displacement so that it is difficult to maximize both. We wish to maximize the force with sufficient displacement to apply that force aerodynamically. This compromise depends on the turning radius and speed of the missile, the aerodynamic balance between wing and aileron, the wing area, the attack angle, and the moment of inertia of the missile. These will be considered in the next section. As an example, for PVDF (polyvinylidene fluoride) bimorphs with physical properties listed in Table III, a deflection of 3° is possible with 1.3×10^4 dyn force (14-g mass equivalent).

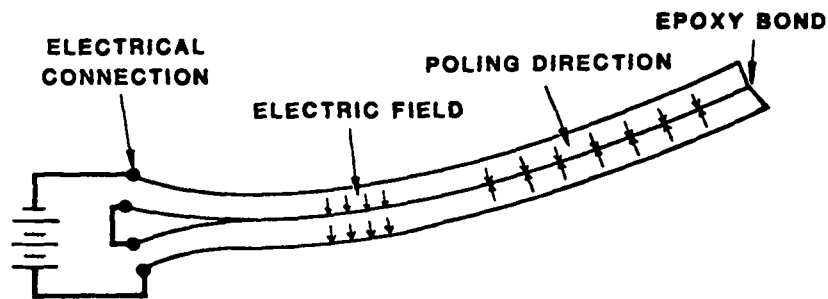

PIEZOELECTRIC BIMORPH METHOD OF OPERATION

Fig. 13. A sandwiched pair of metallized PVDF sheets, poled in opposing directions, bends as voltage is applied.

TABLE III

PVDF MULTIMORPH

D_{31}	$= 2.1 \times 10^{-9}$ cm/V	Piezoelectric coupling coefficient
Y	$= 2.2 \times 10^{10}$ dyn/cm ²	Young's modulus
ϵ	$= 30$ V/ μ m	Dielectric strength
w	$= 4$ cm	Total width of steering fins
ℓ	$= 2$ cm	Length of steering fin
N	$= 20$	Number of layer pairs
t	$= 9$ μ m	Thickness of one layer
V	$= 360$ V	Applied voltage
D_{\max}	$= 0.105$ cm	Maximum displacement at no force
θ_{\max}	$= 3^\circ$	Maximum displacement angle at no force
F_{\max}	$= 1.3 \times 10^4$ dyn	Maximum force at no displacement (13.7 g)

The above calculations are for bimorphs acting as cantilever beams. Mounting the bimorph with one end fixed and a pivot point or bearing at an intermediate position can increase the total deflection.⁶ In addition, the force [Eq. (4)] increases as N^2 while the deflection decreases as $1/N$. This is because the layers are all bonded together. If we could make a multilayer from a number of individual single-pair bimorphs, the force would increase as N and the deflection would be independent of N . This might be accomplished by lubricating the pairs with a liquid which has low viscosity and high surface tension. The low viscosity would permit slip between the layers during bending, but the high surface tension would hold the layers together. Such a combination of 10 layers of $t = 50 \mu\text{m}$ material could give a maximum force of 10^4 dyn (11 g) with a maximum deflection of 11° . There is also a possibility that the effective Young's modulus could be increased by addition of a heterogeneous phase, such as fibers to the polymer.

B. Guidance

There are three proposed scenarios for the missile flight between launch and target acquisition. If dropped from an aircraft or airborne platform, it could follow a preprogrammed descent which optimizes its ability to search for a target (such as a fairly slow maple-seed-type descent followed by a rocket-driven attack on target acquisition). If fired from a ground-based launcher, it could follow a ballistic trajectory with target acquisition turned on after a preset part of the flight (such as lobbing the missile over a hill to unseen targets) or it could be required to fly in a straight path along the line of aim until a target is acquired (this could be uphill, downhill, or a level flight). In the latter case, an active flight control must maintain the proper orientation of the missile to counteract gravity. In larger missiles, gyroscopes are typically used for this purpose and, although some nongyroscopic techniques have been proposed,³⁷ such systems are still too large and expensive for our needs. There are, fortunately, two new developments that offer solutions to this problem. In 1851, Foucault observed that the plane of vibration of a vibrating drill rod in a lathe chuck remained fixed as the chuck was slowly rotated.⁸ This discovery has spawned a number of different types of "linear" gyroscopes whose angular inertia is generated by a vibrating member.⁹⁻¹⁶ One of the successful designs has employed a cylinder vibrating in a cylindrical/elliptical mode normal to its axis.¹⁶ A gyroscope capable of $0.01^\circ/\text{s}$ accuracy for rotation rates of $\pm 60^\circ/\text{s}$ has been made with an overall case size of 1.7 cm diam by

2.4 cm long. This gyroscope is ~20 times more sensitive than needed for our purpose ($\pm 2^\circ$ roll for a 10-s flight time is considered sufficient) and is only a few times too large to be acceptable. Another type of linear gyroscope, called a Tuning Fork Gyro,⁹ based on Foucault's idea, is similar in method of operation to the halteres found on the Diptera fly^{10,11} (an order of flies containing the housefly and horsefly). The halteres are two hair-like projections on the fly's thorax which vibrate during flight and provide, via sensitive organs at the base, a correction which enables the fly to maintain a straight course. If the halteres are removed, the fly cannot maintain a proper flight attitude and crashes soon after takeoff. I believe that it is possible to duplicate halteres in size and sensitivity using silicon carbide, single-crystal fibers grown by the vapor-liquid-solid (VLS) process.³⁸ Very high stiffness (10^8 PSI), high strength (10^6 PSI) fibers with spheres of magnetic iron alloy at one end have been grown with aspect ratios exceeding 10^3 by this process. Typically fibers are 3 to 10 μm in diameter by a few millimeters long. Such fibers are capable of large deflection at high frequency, thus providing large angular momentum, and may be driven at resonance by piezoelectric coupling at the base and measured via magnetic forces on the iron sphere. Such a gyroscope has not yet been built, but should occupy only a few mm^3 and would contain no moving parts other than the vibrating fiber.

One other relevant new technology that may be useful to the guidance system is that of micromechanical silicon devices.^{17,18} Millimeter-size accelerometers have been made by photolithographic techniques on single-crystal silicon wafers and have shown a sensitivity of 2-mV output/ \vec{g} of acceleration.¹⁷ Deviations from a straight flight path of less than 4 m in 500-m range ($\sim 0.5^\circ$) would require 50 μV sensitivity and 3 parts per thousand resolution in the proposed missile. A single linear gyroscope controlling roll coupled with two linear accelerometers could maintain a straight flight in any direction. The gyroscope and accelerometers must be initialized to the desired direction just prior to launch.

The linear gyroscope and accelerometers must provide stabilization for straight line flight until a target is acquired by the IR detector. Then, the IR system generates a steering signal which must be converted to about 300-V bias and applied to the bimorph steering fins. These functions require a micro-processor capable of digitizing the signal from 42 detectors, multiplying by the inverted potential-target-position matrix stored in memory, and generating the

proper steering signal. The processor must also take input from the gyroscope stabilizer during straight flight and give output to the firing circuit when the target is reached. If optional range selection or flight path selection is added, they must also be controlled by the processor. The functions must be performed at a response rate of about 300 Hz.

These requirements are well within the capabilities of present integrated circuitry. This country has large government and commercial R&D programs in VLSI circuitry and in very high speed integrated circuitry design and fabrication. These technologies are relevant to this missile in that it is highly desirable to make the sensors and electronics package as small, cheap, and simple as possible. One obvious way to do this is to put all the electronics on a single chip, preferably even including the IR detectors with their thin-film thermoelectric coolers. Current commercial technology has put 256 K of RAM on a single chip less than 1 cm² in area.²² This density exceeds what is needed for this missile. In addition, current technology allows speeds of more than 10⁶ FLOPS, which is easily capable of performing the necessary control calculations at our preferred operating frequency of 300 Hz.

VI. MISSILE AERODYNAMICS

The aerodynamic design of a missile is a complex balance between a large number of variables and cannot be attempted in a study of this scope. Most large aerospace firms have computer codes for this purpose. I will only try to show that the desired flight properties are physically possible and, in a crude sense, fit into the proposed configuration. We have, in the preceding sections, identified a number of desired performance parameters. I have proposed a missile with a 2-cm-diam body that is 10 cm long; the wings and steering fins extend 2 cm farther from the body on each side; and its weight is <100 g. The desired performance parameters are that with a speed of ~100 m/s it can acquire a target at a range of 50 m, which is within 16 m of its line of flight. The flight will be guided with piezoelectric bimorphs that have limited force and deflection capability. I will need to estimate the moment of inertia (which depends on the partition of mass along the length of the missile and should be made as small as possible) and the aerodynamic balance of the wings, body, and ailerons (which determines the percentage of total lift carried by the steering fins).

To estimate moment of inertia I have assumed a 46-g warhead, a 20-g lens and electronics package, a 12-g rocket motor, and a 10-g case and battery--for a total missile mass of 88 g. With a reasonable distribution of these masses along the length, the moment of inertia is 450 g cm^2 . This could probably be made smaller by optimizing the design. I also assume for the present discussion that the missile is designed so that the wing and the leading, nonmoving edge of the steering fin assembly achieve aerodynamic balance. That is, any force applied by the bimorph is used to rotate the missile about its center of mass and change its aerodynamic attack angle.

Thus, the torque (L) exerted by the steering fin is given by

$$L = \vec{r}_m \times \vec{F} = I\alpha \quad , \quad (6)$$

where \vec{r}_m is the vector from the fin to the center of mass, \vec{F} is the aerodynamic force on the fin, I is the moment of inertia, and α is the angular acceleration caused by the force \vec{F} .

Using the bimorph example given in Table III, where the force is 1.3×10^4 dyn, the displacement is 3° , $r_m = 6 \text{ cm}$, and

$$\alpha = \frac{\vec{r} \times \vec{F}}{I} = \frac{(6 \text{ cm})(1.3 \times 10^4 \text{ dy})}{450 \text{ g cm}^2} = 173 \text{ rad/s}^2 \quad .$$

The angle of rotation $\theta = \frac{1}{2} \alpha t^2$; this is tabulated in Table IV.

TABLE IV

ATTACK ANGLE VS TIME FOR A STEERING FORCE OF 1.3×10^4 dyn

Time From Deflection (s)	Change in Attack Angle (degrees)
10^{-3}	5×10^{-3}
3×10^{-3}	4.5×10^{-2}
10^{-2}	0.5
2×10^{-2}	2
5×10^{-2}	12.4

For a steering fin force of 1.3×10^4 dyn, a 12° attack angle is achieved in 0.05 s. This is only 10% of the flight time for the missile over the 50 m travel distance to the target.

We can now ask what attack angle is needed to cause the missile to execute an 86-m-radius turn. With a missile mass of 88 g, the centripetal force (mv^2/R) for an 86-m radius turn at a velocity (v) of 100 m/s is 10^6 dyn. This is nearly 12 times the acceleration of gravity. The aerodynamic force on a wing is given by³⁹

$$F = \frac{1}{2} C_L \rho v^2 S \quad , \quad (7)$$

when C_L is the aerodynamic constant for the wing (for a narrow wing, $C_L = 0.105 \theta$ where θ is the attack angle in degrees), ρ is the air density, and S the wing area. Then for a narrow wing,

$$F = 0.525 \times 10^{-2} \rho v^2 S \theta \quad . \quad (8)$$

With wings 2 cm wide by 3 cm long and a body 2 cm wide by 10 cm long, which has an aerodynamic lift efficiency of 30% of that of the wing, $S = 18 \text{ cm}^2$. The air density at sea level is about $1.2 \times 10^{-3} \text{ g/cm}^3$, and v is 100 m/s. From Eq. (8) and a force of 10^6 dyn, the required attack angle is about 9° . This attack angle can be achieved, according to Table IV, in <0.05 s.

Provided that the missile can be designed with 99% neutral flight characteristics, the force of 10^4 dyn exerted by the bimorph steering fins is sufficient to cause a 12-g, 86-m-radius turn. For less neutral designs, the wing loading must be reduced to allow the fins a greater share of the load. Since both the centripetal force needed to make a fixed radius turn and the aerodynamic lift on a wing are proportional to v^2 , reducing missile velocity will reduce requirements for neutral flight characteristics. The minimum velocity requirements are that (1) the target must not be allowed to see the missile coming in time to effect an escape and (2) gravity must be counteracted.

It remains to be shown that the deflection available with a bimorph is sufficient to generate 10^4 dyn aerodynamically. We can solve Eq. (8) for the attack angle at a force of 10^4 dyn. With a 2-cm-wide by 2-cm-long bimorph on each of two steering fins, $S = 8 \text{ cm}^2$, and at $v = 100$ m/s, $\theta = 0.2^\circ$. Since the available bimorph force is 1.3×10^4 dyn at 0° and zero at 3° (Table III), the

force at 0.2° will be 1.2×10^4 dyn if the response is linear. Thus, the available deflection is sufficient to apply the needed force. However, as the missile attack angle increases to the 9° needed to execute a 12-g, 86-m-radius turn, the steering fins must correct their attack angle to continue to apply the turning force. The amount and direction of the correction depend on the aerodynamic design of the missile, particularly on the relationship between the center of mass and the center of pressure (what I have called neutrality). It may turn out in the optimum design that more than 3° deflection is required and other bimorph designs (such as the lubricated multipair bimorphs described above) are desirable.

VII. PROPULSION

If the missile is airdropped as a terminally guided submunition (TGSM), then propulsion is probably unnecessary. If it is launched from either a gun or recoilless launcher, a propulsion system is needed to accelerate the missile (if recoilless) and to maintain the desired velocity for the useful range. I have suggested that a rocket motor similar to those sold in hobby shops for \$0.50 cents each would be adequate. At 100 m/s speed, 10 s of burn will allow a 1-km range. I will show in this section that the amount of fuel needed for this application is reasonable.

The aerodynamic drag on a body is given by Eq. (7) if C_L is replaced by C_D (the drag coefficient) and S is the the cross-sectional area. The drag coefficient for a wing is typically 15% of the lift.³⁹ In straight-line flight the lift will equal the weight of the missile ($\sim 10^5$ dyn), so the wing drag will be $\sim 1.5 \times 10^4$ dyn. The drag on the body can be estimated as flat plate drag, for which $C_D = 1$, and S is the missile cross-sectional area. Then from Eq. (7) (where $\rho = 1.2 \times 10^{-3}$ g/cm³, $v = 10^4$ cm/s, and $S = 3.14$ cm²), $F = 1.9 \times 10^5$ dyn and the total missile drag can be estimated as 2×10^5 dyn.

The thrust from a rocket is given by $F = v_e dm/dt$, where v_e is the exhaust velocity, typically 2×10^5 cm/s and dm/dt , the rate of burn of the fuel. If we require the thrust to equal the drag force, then $dm/dt = 1$ g/s and 10 g of rocket fuel is needed for a 10-s flight time. If we also wish to accelerate the 100-g rocket to 10^4 cm/s (conservation of momentum will determine the amount of rocket fuel needed), an additional 5 g of fuel will be required. Thus, the total rocket fuel requirement is 10 to 15 g for a 100-g missile.

Hobby rockets use a cardboard case with a small ceramic nozzle. Such a case and nozzle would weigh ~ 2 g. I have, therefore, estimated the weight of the rocket to be ~ 12 g for the gun-launched version.

The recoil from a 100-g projectile launched at 100 m/s has a momentum of 10^6 g cm/s. By comparison, the 7.62-mm NATO rifle firing a 150-grain (10-g) bullet at 2700 ft/s (823 m/s) has a momentum of 8×10^5 g cm/s. In addition, because the low-velocity rocket has a longer acceleration time, the recoil will be "softer" than that of the 7.62 NATO.

VIII. WARHEAD DESIGN

The envisioned warhead for this missile is a rather unimaginative design composed of a cylindrical shell of tungsten spheres embedded in plastic surrounding a core of high explosive. It could be detonated with a small, electrically driven detonator located along the cylinder axis or at one end. In apportioning space in this 2-cm-diam missile, I have allocated 3 cm length and 12 g for the rocket motor, 3 cm length and 48 g for the warhead, and 4 cm length and 30 g for the lenses, detectors, electronics guidance, and power supply. The remaining mass is the case and wings. Thus, the warhead can occupy a 2-cm-diam by 3-cm-long volume and have a mass of 48 g. A 2-cm-diam by 3-cm-long cylindrical shell of 2-mm-diam tungsten spheres, arranged in rows, would contain 450 spheres with a total mass of 36.4 g. An epoxy filler for this shell would add ~ 2 g. Filling the 1.6-cm-diam by 3-cm-long void with explosive at a density of 1.5 g/cm^3 adds 9 g, for a total warhead mass of 47.4 g. A similar warhead using lead spheres would be cheaper and could contain >750 spheres. The larger number of pellets may more than offset the hardware and density advantage of tungsten.

While I have assumed that the missile will actually hit the person under attack, it is desirable that the warhead have a kill radius as large as possible within size and weight limitations. This would allow for multiple kills of closely spaced targets and assure a kill if the missile homes in on a rifle or other nearby warm objects. A shotgun that can put 70% of a 1-oz shot load into a 30-in. (76-cm) circle at 40 yds (37 m) is considered effective at 40 yds. Depending on shot size, this is ~ 220 pellets/ m^2 (No. 4 shot). If we assume the same pellet density is needed (about nine pellets in our 20- by 20-cm target), then the range of the warhead is 0.4 m. While this is probably sufficient for

"arms-length" kills and would be lethal for the target struck, greater warhead range would certainly be desirable. The use of lead pellets would help increase this range.

IX. POWER SUPPLY

Although the depth of this design does not allow detailed electrical power specifications, the requirements outlined in Table V estimate the power needed.

The battery chosen to supply this 65 W-s energy at 5.8 W must have a long shelf life, be light and compact, and have a high-energy density. Batteries with sufficiently low internal resistance are not commonly available but several technologies have potential for this application. Currently available lithium sulfur-dioxide batteries have energy storage densities of 1.9×10^3 W-s/cm³ and of 1.2×10^3 W-s/g.²³ These batteries have an excellent shelf life and can be made with sufficient short-term current capability; they are not rechargeable. Miniature fuel cells have also been developed for high-power applications. The 65 W-s needed is equivalent to the chemical energy available in 15 mg of fuel. The fuel cell would be activated as part of the prelaunch initiation (expected to require 1 to 4 s). Polyacetylene batteries also promise high-current, high-energy density storage, and are rechargeable, long-life devices. This emerging

TABLE V
ESTIMATED ELECTRICAL POWER REQUIREMENTS

<u>Item</u>	<u>Voltage (V)</u>	<u>Current</u>	<u>Time (s)</u>	<u>Power</u>	<u>Energy (W-s)</u>
Bimorphs	±300	0.2 mA	10	60 mW	0.6
Detectors	+100	µA	10	Negligible	Negligible
Computer	6	0.1 A	10	600 mW	6
Thermoelectric Cooler	2	2 A	14	4 W	56
Gyroscope	2	50 mA	12	100 mW	1.2
Detonator	2	0.5 A	1	1 W	1

technology, while not yet available commercially, has been suggested as a replacement for lead-acid automobile batteries. The polymer is readily moldable and could be used as the missile case. Estimates of current capability and internal resistance are, however, premature. The major portion of the power requirement listed in Table V is the thermoelectric cooler. It is possible that sufficient cooling could be supplied by the launcher power supply, so that in-flight cooling would not be necessary. Similarly, if a cooled detector is not needed, the power requirements are drastically reduced.

X. UNCERTAINTIES IN DESIGN AND FEASIBILITY

It will be apparent to the reader that there are a number of uncertainties in the proposed design that must be studied more carefully before a prototype missile can be fabricated. Probably the most important is the problem of the IR detection of human targets under realistic conditions. Questions that must be answered are: What is the effect of average background temperature and sunshine on the background clutter problem? Can multiaperture optical systems discriminate target temperature (color) and/or shape to help reject decoys and false targets? What is the envelope of conditions for which the seeker will work--and is this sufficient to make the idea worthwhile? These are not questions that can be answered by the "gut feeling" of even the most experienced IR detector specialist.

Other questions relate to operational parameters such as: What type of fuzing would be best? Should there be a "minimum range" adjustment? How much "last-minute" information should be entered by the launcher? What speed and range are necessary?

Then there are the innumerable design optimization questions such as: How much force and deflection can be obtained from a piezoelectric steering fin and what is the best balance between these? How many lenses and detectors are needed? What is the optimum design for the minigyroscope and how much stability can it deliver? How will the detectors and VLSI circuitry be put together? And what should the aerodynamic package look like--canards or ailerons, positive or negative balance, and banked turns or cruciform wings?

There are also all the questions concerned with launch options and attack mode. Should the air-drop version be fast descent or a slow spiral? What usefulness is there in a slow-flying model airplane version? Should the flight be ballistic, straight flight, or programmed? And, should the launch be recoilless?

Finally, using this concept, what other homing sensors might be used? Could a sonar homer be developed to sense moving objects or hard metal objects?

XI. BELLS, WHISTLES, AND COST CONTROL

In the previous section a number of questions were raised--probably more than were answered. Such questions can fire the imagination and are fun to consider. However, we must always keep in mind that cost effectiveness is the most important design parameter for this missile. It must not become an end-all, do-everything infantry weapon or it will be destroyed in the process. The most simple workable design should remain the goal, and bells and whistles should be staunchly avoided. Many weapons use several types of ammunition, and it is not a large penalty to make a few different missiles for different needs.

It is beyond the scope of this study to estimate the cost for this missile. Most parts will be made using new, state-of-the-art, and emerging technologies, production will require extensive development and design, and mass production of millions of units will be desired. The factory making these missiles will have to use state-of-the-art and robotic- and computer-aided manufacture. However, some of the parts are currently available. A few suggestions for cost control follow.

- Rocket Motors--these are available in any hobby shop. Current motors burn too fast with too much thrust for our needs, but that can easily be changed. Current retail price is ~\$0.50.
- Bimorphs--PVDF sheet film with electrodes is available and needs only a reason for commercial production of layered bimorphs.
- The case and wings can be a one-piece injection molding of polystyrene or polyactylene battery material.
- The gyroscope stabilizer must be miniaturized to fit in this missile, which implies automated assembly. A linear gyroscope will not be complex or involve sophisticated parts.

- Detectors on a wafer substrate can be applied using thin film technology. Present problems with IR detectors are avoided with multi-aperture systems, since if 80% of the detectors work the chip is acceptable. Also, it does not matter whether the individual detector gains match. Thermoelectric coolers can be made with the same thin film technology. IR transmitting, chalcogenide glass lenses can be molded or pressed and do not need any finishing at these wavelengths. Some optical coating may be desirable. This technology is making enormous progress and 5 years will see a large reduction in the difficulty of manufacture.
- Assembly of the components will be easy if the components are built as individual packages which stack together in the case. Testing and programming can be an automated, computer-controlled process.

It is always risky to make an analysis like this because it is much easier to shoot down a new suggestion than it is to come up with a better one. In addition, disbelievers will try to make the whole concept hinge on a single exception to an estimated or preliminary number; in the end, an over-zealous designer may try to make the whole idea into a "silver bullet" cum "white elephant." Nevertheless, the technology is there, the potential for cost effectiveness is there, and the operational usefulness is there.

XII. ACKNOWLEDGMENTS

I am indebted to a large number of people whose contributions made the various parts of this concept come together into a feasible system. Capt. Lee Schrock of the US Air Force Academy introduced me to multiaperture optical systems and essentially wrote Section IV.C. Andy Lieber, Harold Vaughn, and John Phelan of Sandia National Laboratories in Albuquerque, and Ed Cort of this Laboratory, very patiently explained the dynamics of missile flight and provided very helpful discussions of missile guidance and control. Herbert Flicker and Suzanne Stotlar provided many ideas on IR detection technology. John Milewski grew a special batch of silicon carbide fibers to prove that the sphere on the end of the fiber could be a magnetic alloy.

Special thanks go to Harry Reynolds (NSP/AWT) for his encouragement and support and for his initial suggestion (which led to this concept) that a small antipersonnel missile would be useful. The members of the Advanced Weapons

Technology group have been a continual source of encouragement and inspiration. My thanks also go to the many others throughout the Laboratory who helped in innumerable ways.

REFERENCES

1. William G. McMillan, Science Associates, Inc. (November 1983).
2. "Elastic properties of piezoelectric PVF_2 ," Minoru Toda, J. Appl. Phys., 51, 4673 (1980).
3. "Electromotional Device Using PVF_2 Multilayer Bimorph," Minoru Toda, Trans. IECE, Japan, 61, 507 (1978).
4. "Design of Piezoelectric Polymer Motional Devices with Various Structures," Minoru Toda, Trans. IECE, Japan, 61, 513 (1978).
5. "The Deflection-Bandwidth Product of Poly(Vinylidene Fluoride) Benders and Related Structures," J. Kelley Lee and Michael A. Marcus, Ferroelectrics, 32, 93 (1981).
6. "Voltage-Induced Large Amplitude Bending Device- PVF_2 Bimorph--Its Properties and Applications," M. Toda, Ferroelectrics, 32, 127 (1981).
7. "High Field Dielectric Loss of PVF_2 and the Electromechanical Conversion Efficiency of a PVF_2 Fan," M. Toda, Ferroelectrics, 22, 919 (1979).
8. "Démonstration physique au Mouvement de Rotation de la Terre au Moyen du Penduee," J.B.L. Foucault, C R Acad Sci (Paris), 32, 135 (1851).
9. "A New Space Rate Sensing Instrument," Joseph Lyman, Aeronaut. Eng. Rev., p. 24 (November 1953).
10. "A New Gyroscopic Instrument," A. L. Percival, Nature, 173, 572 (1954).
11. "Gyros, Powerful Tools in Aerospace Technology," Kurt Magnus Aeronautical J., p. 346 (August 1978).
12. "Gyroscopic Apparatus," William D. Mullins et al., US Pat. 3,106,847 (October 15, 1963).
13. "Angular Direction Sensor," Bo H. G. Ljung, et al., US Pat. 3,913,405 (October 21, 1975).
14. "Vibrating Ring Gyro," John C. Stiles, US Pat. 3,924,475 (December 9, 1975).
15. "Theory and Error Analysis of Vibrating Member Gyroscopes," Bernard Friedland and Maurice F. Hutton, IEEE Trans. on Auto. Control, AC-23, 545 (1978).

16. "The Vibrating Cylinder Gyro," R. M. Langdon, The Marconi Rev., p. 231 (Fourth Qtr., 1982).
17. "Silicon Micromechanical Devices," James B. Angell, Stephen C. Terry, and Phillip W. Barth, Sci. Am., p. 44 (April 1983).
18. "Microfabrication as a Scientific Tool," R. E. Howard, P. F. Liao, W. J. Skocpol, L. D. Jackel, and H. G. Craighead, Science, 221, p. 117, July 8, 1983.
19. "Assessment of Mercury-Cadmium Telluride Materials Technology," p. 127, National Materials Advisory Board report 377 (1982).
20. See commercial vendor literature. For example, Coherent Components Group, 2301 Linbergh St., Auburn, CA 95603, or Spectron, Vinten Electro-Optics Ltd., Ashville Trading Estage, Nuffield Way, Abingdon, Oxon OX141TD, England.
21. "Research on Missile Seeker Head Energy Transfer Technology," Roy A. Walters, Lee W. Schrock, and Richard T. Schneider. Final report USAF contract No. F08635-80-C-0108, Jim Long, AFATL/DLMI, Elgin AFB. Authors were with Dept. of Nuclear Eng. Sci., Univ. of Florida, Gainesville, Florida.
22. "Dynamic Random Access Memory of 256K on a Single Chip," recent advertisement by the Western Electric Company.
23. "Eternacell® Lithium Sulfur-Dioxide Batteries," Power Conversion Inc., 495 Boulevard, Elmwood Park, NJ 07407.
24. Handbook of Military Infrared Technology, SPIE Vol. 219, p. 19, for 5° downlook onto grass, midday condition.
25. While the resolution of the human eye is better than 2 cm at 50 m, it is very difficult to detect a single spot even against a uniform background. It is unlikely that even an alert person could detect the missile against a battlefield background at a distance greater than 30 m.
26. See, for example the products offered by Optoelectronics, Inc., 1309 Dynamic St., Petaluma, CA 94952.
27. The Infrared Handbook, William L. Wolfe and George J. Zissis US Government Printing Office, 1978, p. 11-74.
28. The Infrared Handbook, p. 11-85.
29. The Infrared Handbook, p. 11-73.
30. The Infrared Handbook, p. 22-95.
31. The Infrared Handbook, p. 11-97.

32. "Multiple Aperture and Single Aperture Optical Imaging System Comparisons for Correct Detection Probability and Resolution," S. C. Kellogg, R. L. Phillips, and R. A. Walters, National Aerospace and Electronics Conference (NAECON), May 17-19, 1983, Dayton, Ohio.
33. "Robotic Vision Using Spatial Optical Sampling," R. A. Walters, IEEE Southeast Conference 1983, Orlando, Florida, April 11-13, 1983.
34. "A Method for Sparse Linear Least Squares Problems," A. Bjork, Sparse Matrix Computations, Academic Press, New York (1976).
35. "Imaging and Identification Techniques Associated with Distributed Aperture Optics," Lee W. Schrock, Ph.D. Dissertation, Univ. of Florida, 1981.
36. PVF₂ film is available from the Kynar Piezo Group, Pennwalt Corporation, 900² First Ave. King of Prussia, Pennsylvania, 19406-0018.
37. A technique for missile stabilization using a rotating coil magnetometer to measure the direction of the earth's magnetic field was described to me by Harold Vaughn of Sandia National Laboratories, Albuquerque, New Mexico, July 14, 1983.
38. "Production and Characterization of Beta-Silicon Carbide and Alpha-Silicon Nitride Whiskers for Ceramic Matrix Composites," John V. Milewski, F. D. Gac, and J. J. Petrovic, Los Alamos National Laboratory report LA-9650-MS (February 1983).
39. Airplane Aerodynamics, David O. Dommasch, Sydney S. Sherby, and Thomas F. Connolly, Pitman Publishing Co., New York, New York, Fourth ed., p. 108 (1967).